

Physiology and Pathophysiology for Engineers and Physicists

Teachers:

Elias Kouvelas, Prof. Emeritus, Medical School, University of Patras

* **George Kostopoulos**, Prof. Emeritus, Medical School, Univ. of Patras

Adamantia Mitsacos, Prof. Emeritus, Medical. School, Univ. of Patras

- = part 1 = Introduction to Physiology and its principles +
- - part 2 - Neurophysiology

Course Description

Purpose:

Designed to bring to engineering students a **general awareness** of the function of whole organisms, their component cells, organs, and organ systems as well as the basic mechanisms leading to disease

Contents:

An overview of human physiology & Pathophysiology

Cellular physiology (some pointers to subjects introduced in previous modules, which are important prerequisites for understanding Physiology)

Circulatory and respiratory physiology

Physiology of the gastrointestinal system

Hormonal control – physiological modelling

Neural integration and control of body and behavior

Duration: 1 module – 20 X 2 hours

Time: starting 24 October 2022 see calendar

Συγγράμματα Φυσιολογίας:

Despopoulos and S. Silbernagl 2003, “Color Atlas of Physiology”, Thieme 5th edition. [και Ελληνική μετάφραση της 2ης εκδ], Ιατρικές Εκδόσεις Λίτσα.

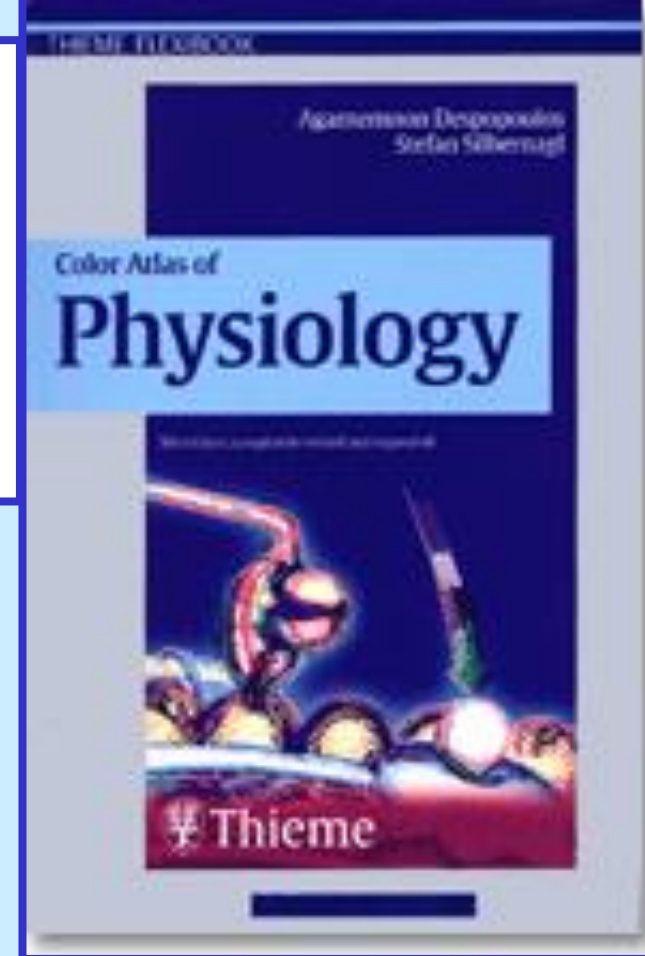

Άλλα συγγράμματα στα Ελληνικά:

- Vander MD, Sherman PhD, Luciano PhD, Τσακόπουλος Μ.** Φυσιολογία του Ανθρώπου. Ελλ. Μετάφρ. Εκδ. Πασχαλίδη 2001
- Koepfen BM and Stanton BS**, “Berne & Levy Αρχές Φυσιολογίας”. Ελληνική μετάφραση. Εκδόσεις Παρισιάνου, 2003.
- W. Boron & E. Boulpaep**: *Medical Physiology. A cellular and molecular approach*. Σε Ελληνική μετάφραση, Εκδ. Πασχαλίδη).

Προεκτάσεις παθοφυσιολογίας:

S. Silbernagl/F. Lang: **Color Atlas of Pathophysiology** 2000. 406 pp, 180 illustrations, ISBN 0865778663 / 3131165510 Georg Thieme Verlag



Resources:

Textbook: (any one, but **mandatory to own**) :

Despopoulos and S. Silbernagl 2003, “**Color Atlas of Physiology**”, Thieme 5th edition. Translated in all major languages [και Ελληνική μετάφραση, Ιατρικές Εκδόσεις Λίτσα]

- **Exams** will be based on material presented and selected from any textbook of Physiology
- **Lectures** are not exhaustive.
- Some **handouts** will be given to you to help with **PATHOPHYSIOLOGY** – only some elementary stuff.
- **Attendance** and active participation in lectures (which demands a good command of **English**) are **mandatory** for allowance to take part in the exams

send me questions at: **gkkostop@upatras.gr**



εγχειρίδιο
φυσιολογίας
με έγχρωμο άτλαντα

Agamemnon Despopoulos
Stefan Silbernagl



Suggested extra supplements:

1. S. Silbernagl/F. Lang: **Color Atlas of Pathophysiology**

2000. 406 pp, 180 illustrations, ISBN 0865778663

/ 3131165510 Georg Thieme Verlag

2. DU Silverthorn “**Human Physiology; An integrated approach**” chapter. 1, 6 and 8-13, Pearson Education Int.2001, 185 pages.

3. “**Brain Facts**” 2009, a 74-page primer, published by the Society for Neuroscience (USA) available at

<http://www.sfn.org/index.aspx?pagename=brainFacts>

4. **Neuroscience: The Science of the Brain** by BNA free download

5. (advanced – in library) “**Essentials of neural science and behavior**”

Appleton & Lange, 1995 / edited by Eric R. Kandel, James H.

Schwartz and Thomas M. Jessel / μεταφρασμένο στα Ελληνικά

"Νευροεπιστήμη και Συμπεριφορά", από τους Α. Καραμανλίδη, Γ.Χ. Παπαδόπουλο και Χ. Καζλαρή, Πανεπιστημιακές Εκδόσεις Κρήτης 1997)

In translation:

1. **Vander MD, Sherman PhD, Luciano PhD, Τσακόπουλος Μ.** Φυσιολογία του Ανθρώπου. Ελλ. Μετάφρ. Εκδ. Πασχαλίδη 2001

2. **Berne RM and Levy MN** Αρχές Φυσιολογίας. Ελληνική μετάφραση. Παν Εκδόσεις Κρήτης κεφ. 1-3, σελ. 3-52

3. **W. Boron & E. Boulpaep: Medical Physiology. A cellular and molecular approach.** Σε Ελληνική μετάφραση, Εκδ. Πασχαλίδη).

Very brief: Laurie Kelly McCorry : Essentials of human Physiology for Pharmacy, Second Edition (also electronic) p.: 362, 2004, Routledge, USA



Course procedures - Τα διαδικαστικά

Η εξεταστέα ύλη είναι από το περιεχόμενο του βιβλίου των Desropoulos and Silbernagl και ότι σημειώσεις σας δοθούν σε εκτύπωση ή σε e-class (ιδιαίτερα για τη Παθοφυσιολογία), οδηγούμενοι και από τις παραδόσεις που θα αναρτώνται στο e-class

Οι παραδόσεις δεν εξαντλούν τη διδακτέα/εξεταστέα ύλη, αλλά σας βοηθούν να την κατανοήσετε και να αναγνωρίσετε ποια είναι τα σημαντικότερα σημεία της.

Τα μαθήματα θα είναι **διαδικτυακά** αλλά και **διαδραστικά**.

Η παρακολούθηση και ενεργός συμμετοχή στο μάθημα αποτελούν προϋπόθεση συμμετοχής στις εξετάσεις

Επικοινωνία:

Γραμματεία Φυσιολογίας: 2610-969155

Γ. Κωστόπουλος gkkostop@upatras.gr

part 1 - general physiology

- Definition of Physiology
- Definition of Pathophysiology
- Elements of an organism
- Homeostasis – define disease
- Control systems and body communication
- Energy balance
- Methods in physiology
- **What is life?**

What is a Physiologist?



- Physiologists are interested in function and integration
i.e. how things work *together* at various levels of organisation \Rightarrow whole organism
- When studying parts of organisms (even single molecules) a physiologist will seek to establish the relevance of any information derived to the function of the whole body

Physiology =

- The study of the functions of a living organism and its component parts. Includes chemical and physical processes.
- Formalized by 16th century as the study of the vital functions of the human body. Now includes study of plants and animals.
- Cannot be fully separated from anatomy, the study of structure. (Form follows function..) Also prerequisites: biology & biochemistry

Physiology – An Integrative Science

- Few unanswered questions remain about how the human body works at the **systems level** – most involve nervous control.
- Bulk of research is at cellular and **molecular level**.
- Must look at links between cells, tissues, and organs to fully understand functions.. – **integration**

Function Versus Process

- **Teleological** approach (function) – Why does something exist or occur?
 - **Mechanistic** approach (processes) – How does something occur?
- Use Example -1 : the pumping of blood by the heart or
Example 2 : why there are differences in skin color between
Caucasians and Africans.
- to show the difference between a teleological approach to
physiology and a mechanistic approach.

The **mechanist view** of life, the view taken by physiologists, holds that all phenomena, no matter how complex, can ultimately be described in terms of physical and chemical laws.

In contrast, **vitalism** is the view that some “vital force” beyond physics and chemistry is required to explain life.

The **mechanist view** has predominated in the twentieth century because virtually all information gathered from observation and experiment has agreed with it.

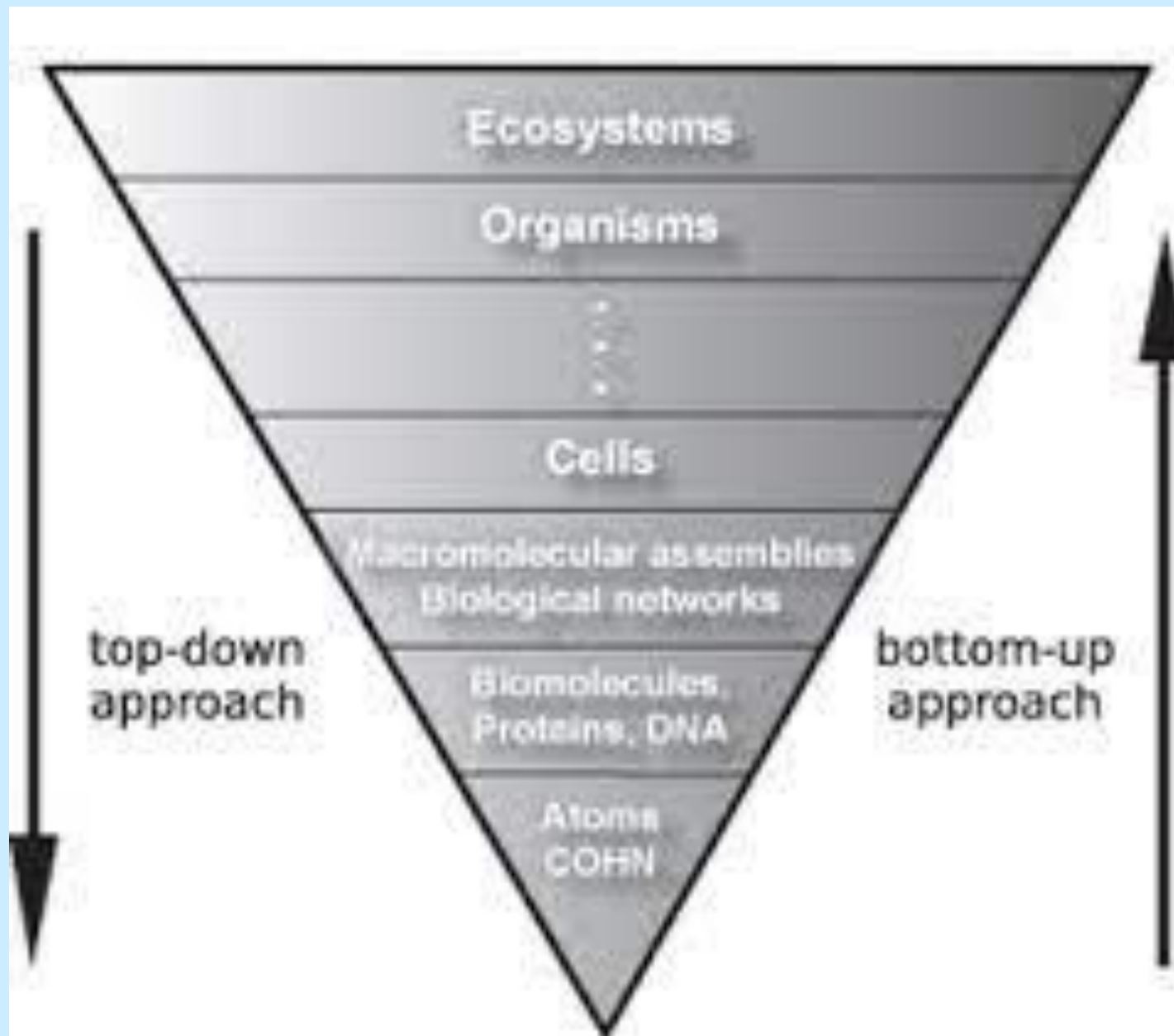

Levels of Organization

Research methods can take either of two directions:

induction

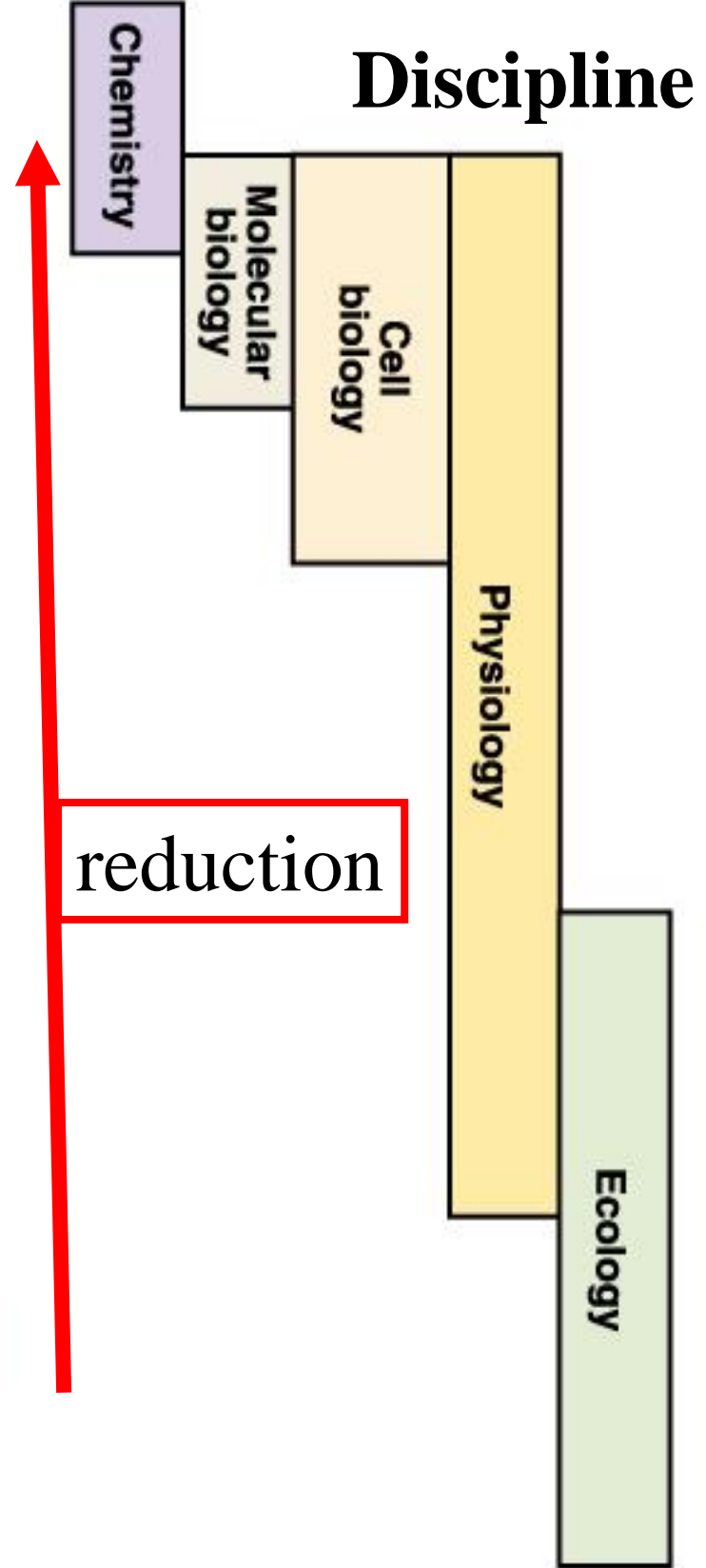
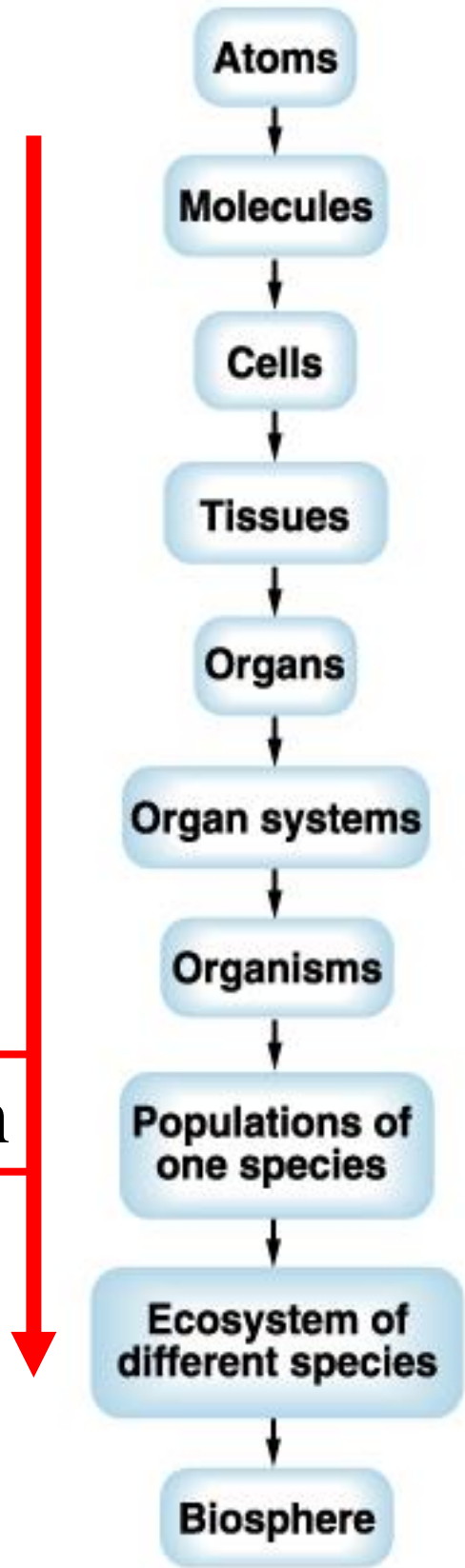

reduction

Discipline

INDUCTION -Inductive reasoning involves forming general theories **from specific observations**. Observing something happen repeatedly and concluding that it will happen again in the same way is an example of inductive reasoning.

DEDUCTION - deductive reasoning involves forming specific conclusions **from general premises**, as in:
everyone in this class has a nose; therefore, I have a nose.

1. Cells

4 levels of organization

- Cells are the **basic structural units** of all plants and animals.
- **All** organisms are composed of one or more cells.
- Cells are the **smallest functioning units** of life.
- All cells **come** from preexisting cells.
- Cells maintain homeostasis.

2. Tissues – Collections of cells that carry out related functions.

3. Organs

If you disassembled organs into tissues and sorted the tissues into piles based on their basic functions, there would only be 4 categories:

- Epithelium
- Connective Tissue
- Muscle Tissue
- Neural (Nervous) Tissue

•4. Systems

Service Functions

- Cardiovascular system
- Respiratory system
- Digestive system
- Renal system
- Reproductive system
- Musculo-skeletal system
- Nervous system
- Endocrine system
- Immune system



Service Functions

- **Cardiovascular system**
- **Respiratory system**
- **Digestive system**
- **Renal system**
- **Reproductive system**
- **Musculo-skeletal system**
- **Nervous system**
- **Endocrine system**
- **Immune system**

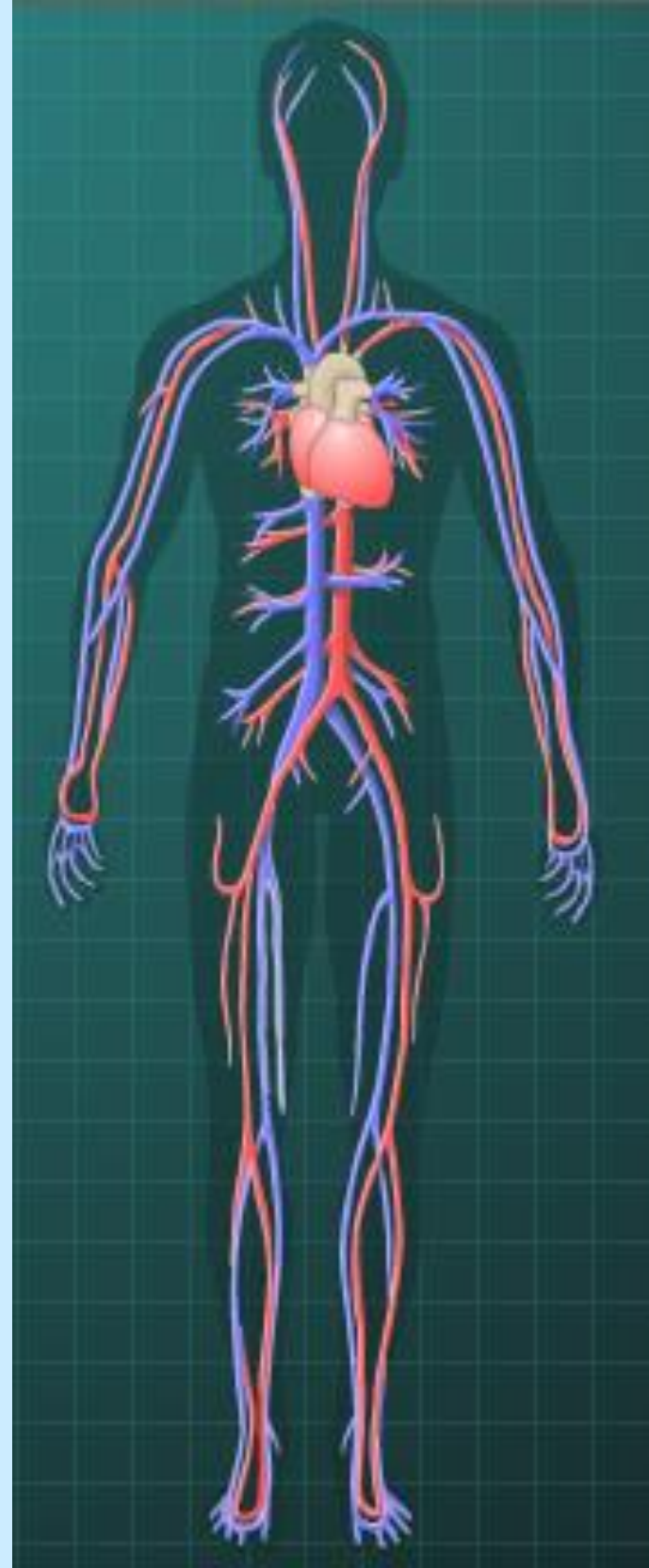

Service Functions

- Cardiovascular system
- **Respiratory system**
- Digestive system
- Renal system
- Reproductive system
- Musculo-skeletal system
- Nervous system
- Endocrine system
- Immune system

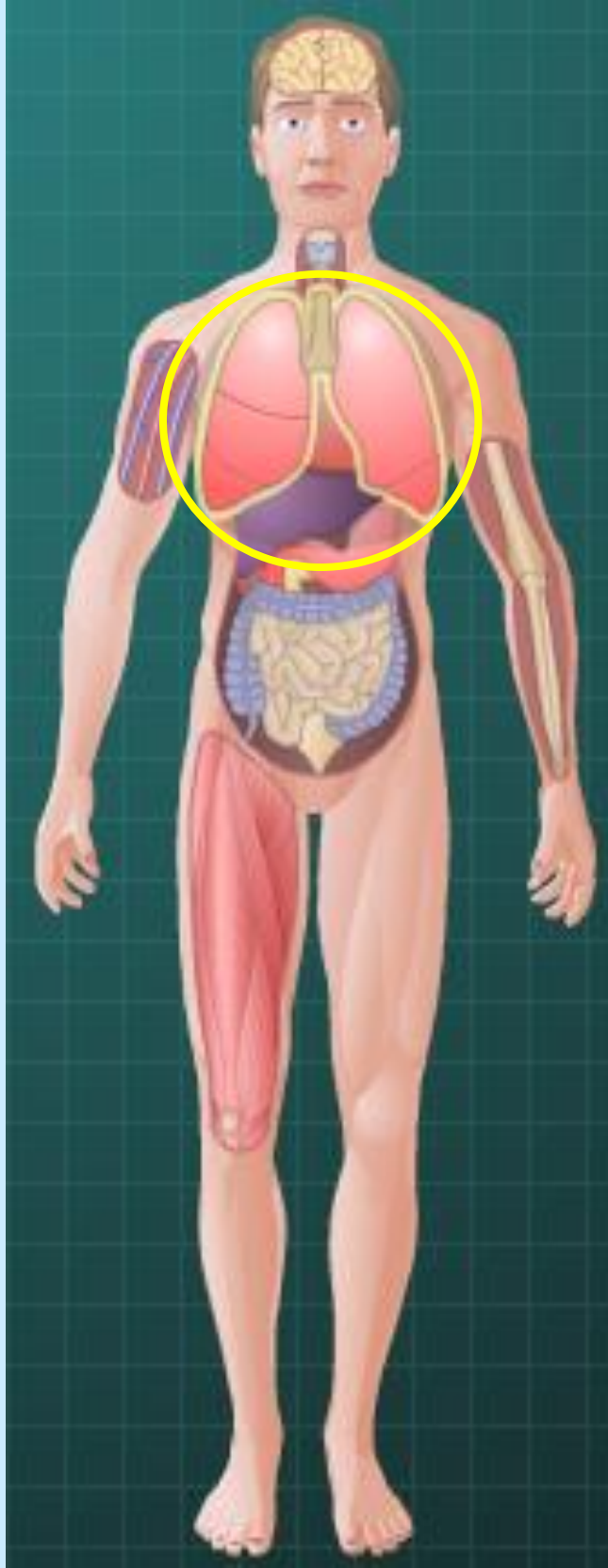

Service Functions

- Cardiovascular system
- Respiratory system
- **Digestive system**
- Renal system
- Reproductive system
- Musculo-skeletal system
- Nervous system
- Endocrine system
- Immune system

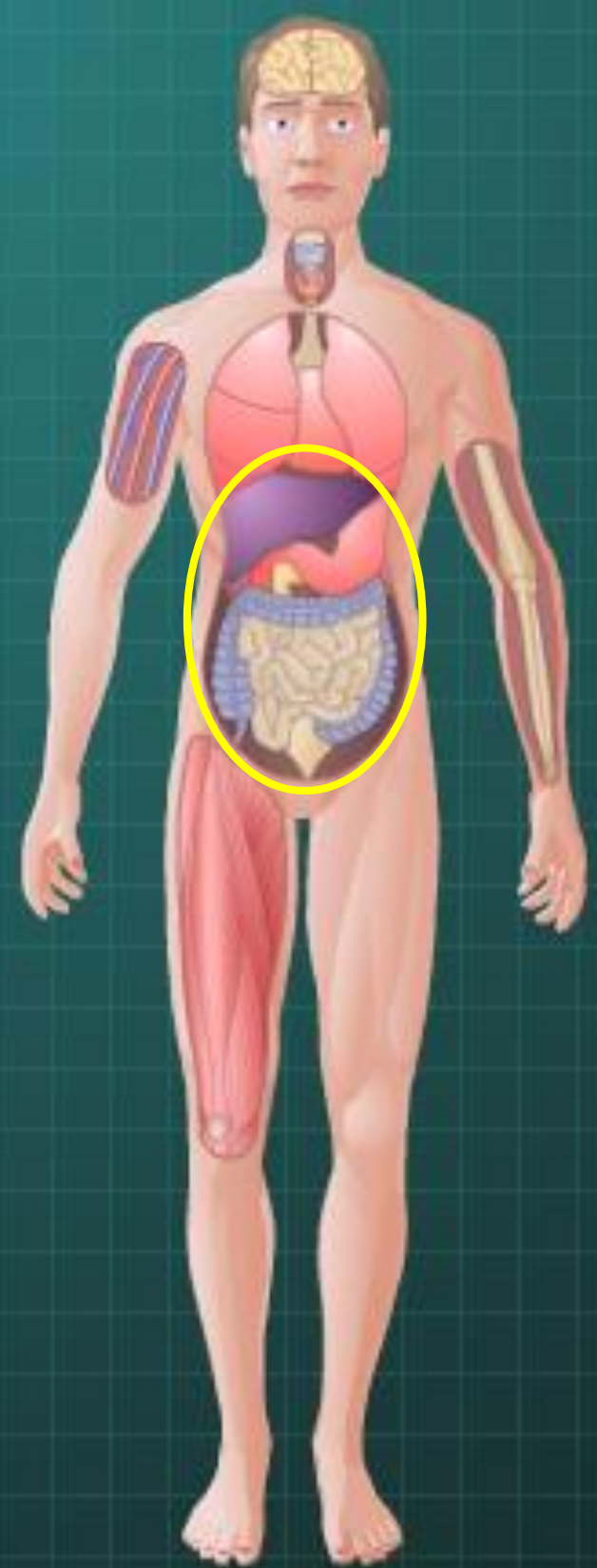

Service Functions

- Cardiovascular system
- Respiratory system
- Digestive system
- **Renal system**
- Reproductive system
- Musculo-skeletal system
- Nervous system
- Endocrine system
- Immune system

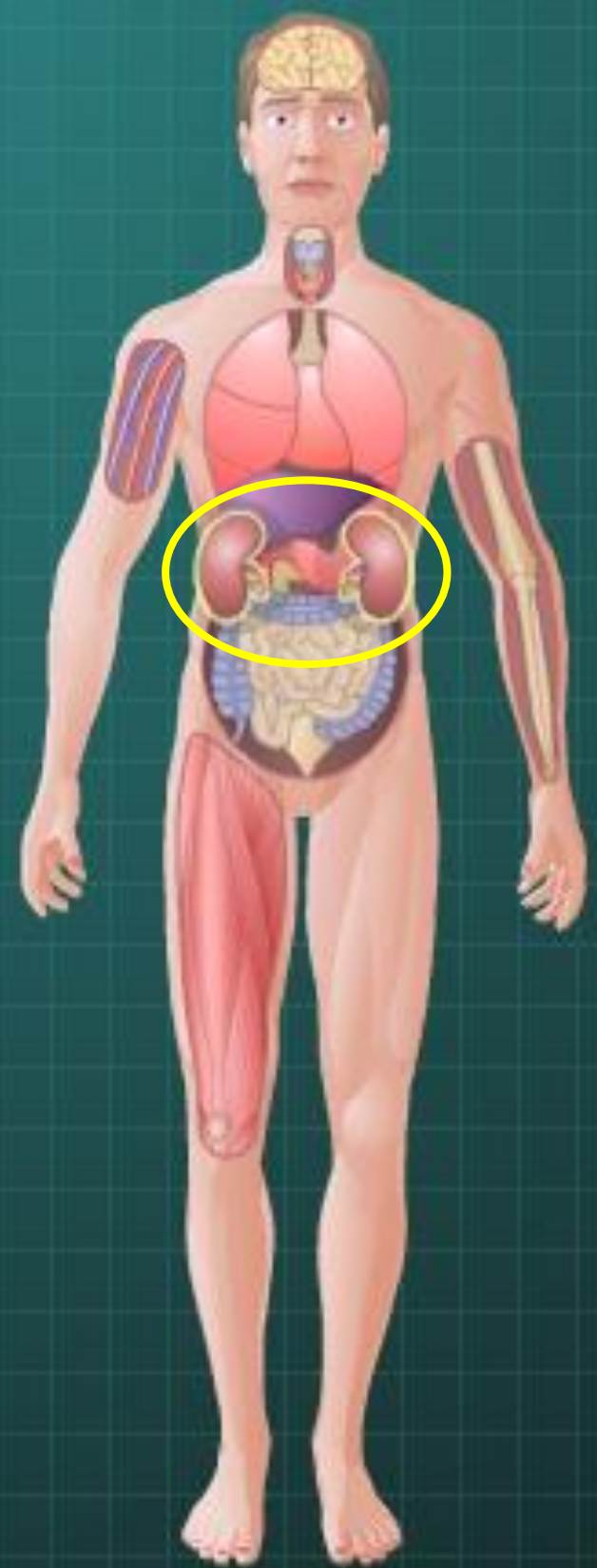

Serviced Function?

- Cardiovascular system
- Respiratory system
- Digestive system
- Renal system
- **Reproductive system**
- Musculo-skeletal system
- Nervous system
- Endocrine system
- Immune system



Serviced Function?

- Cardiovascular system
- Respiratory system
- Digestive system
- Renal system
- **Reproductive system**
- Musculo-skeletal system
- Nervous system
- Endocrine system
- Immune system

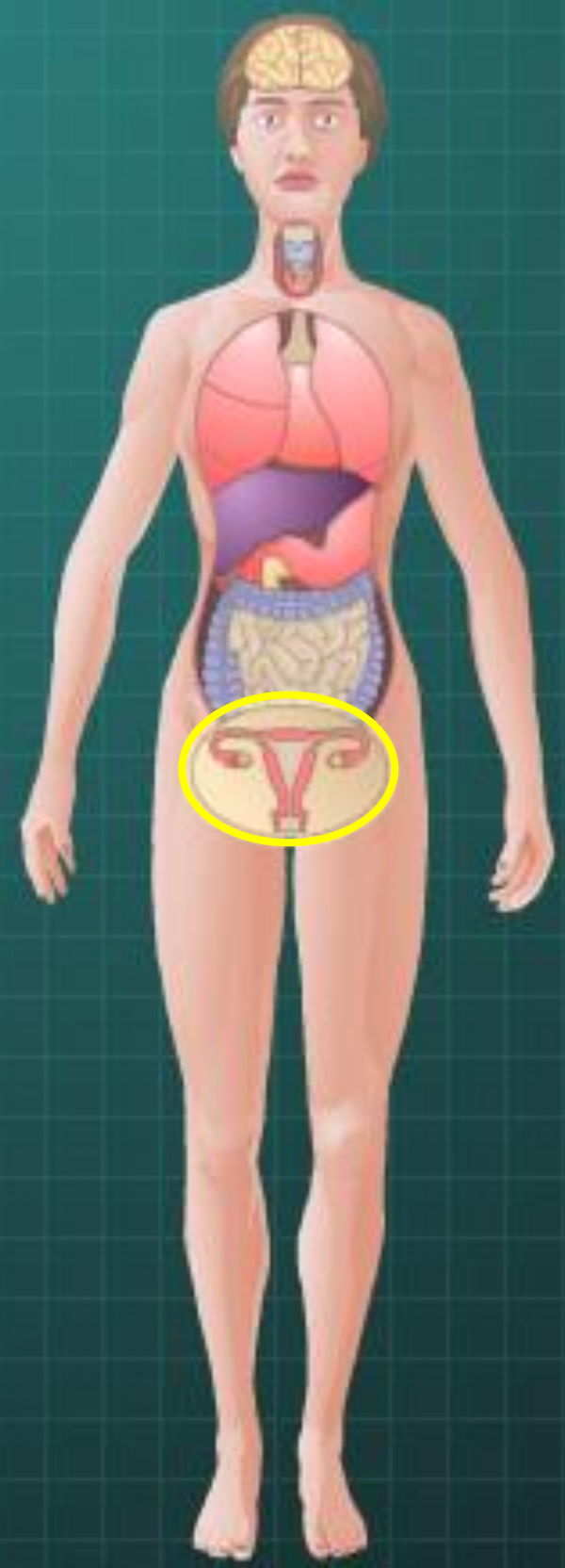

Service Functions

- Cardiovascular system
- Respiratory system
- Digestive system
- Renal system
- Reproductive system
- **Musculo-skeletal system**
- Nervous system
- Endocrine system
- Immune system



Serviced Function?

- Cardiovascular system
- Respiratory system
- Digestive system
- Renal system
- Reproductive system
- **Musculo-skeletal system**
- Nervous system
- Endocrine system
- Immune system

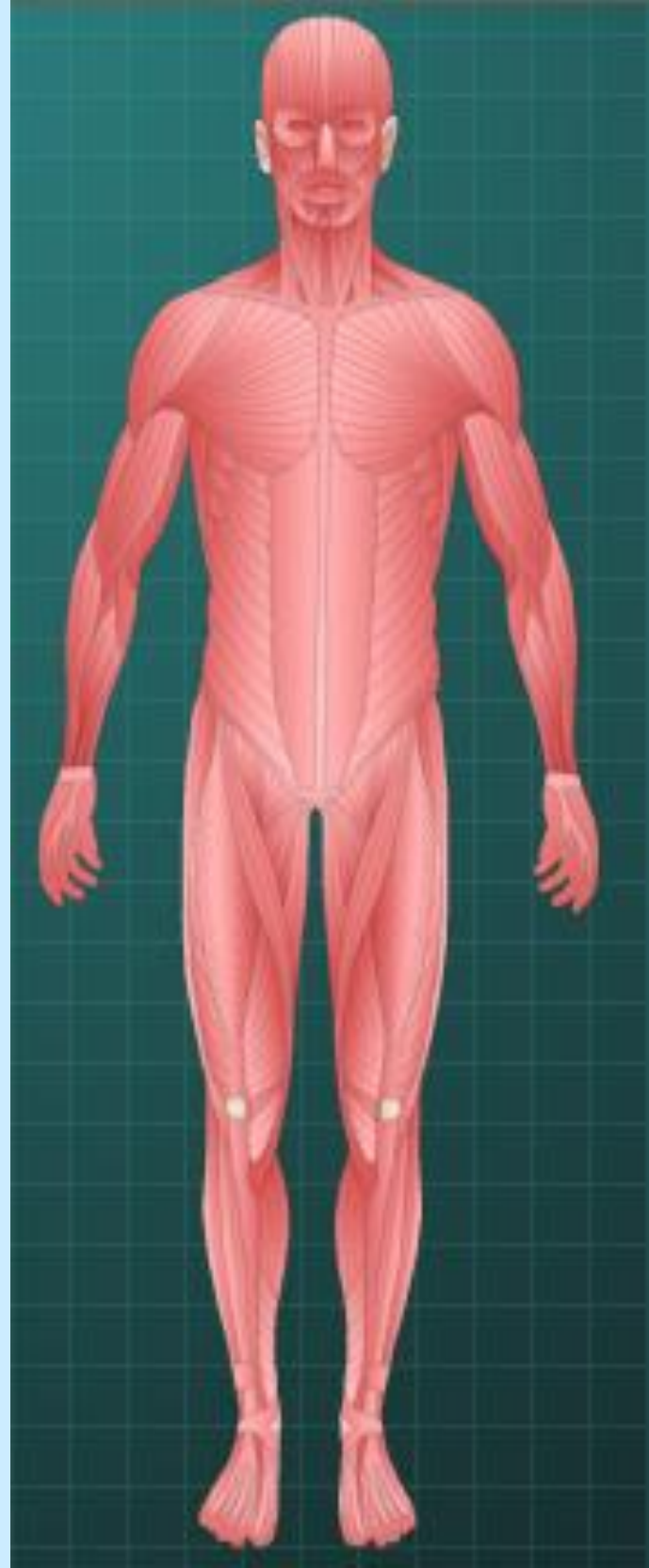

Service Functions

- Cardiovascular system
- Respiratory system
- Digestive system
- Renal system
- Reproductive system
- Musculo-skeletal system
- **Nervous system**
- Endocrine system
- Immune system

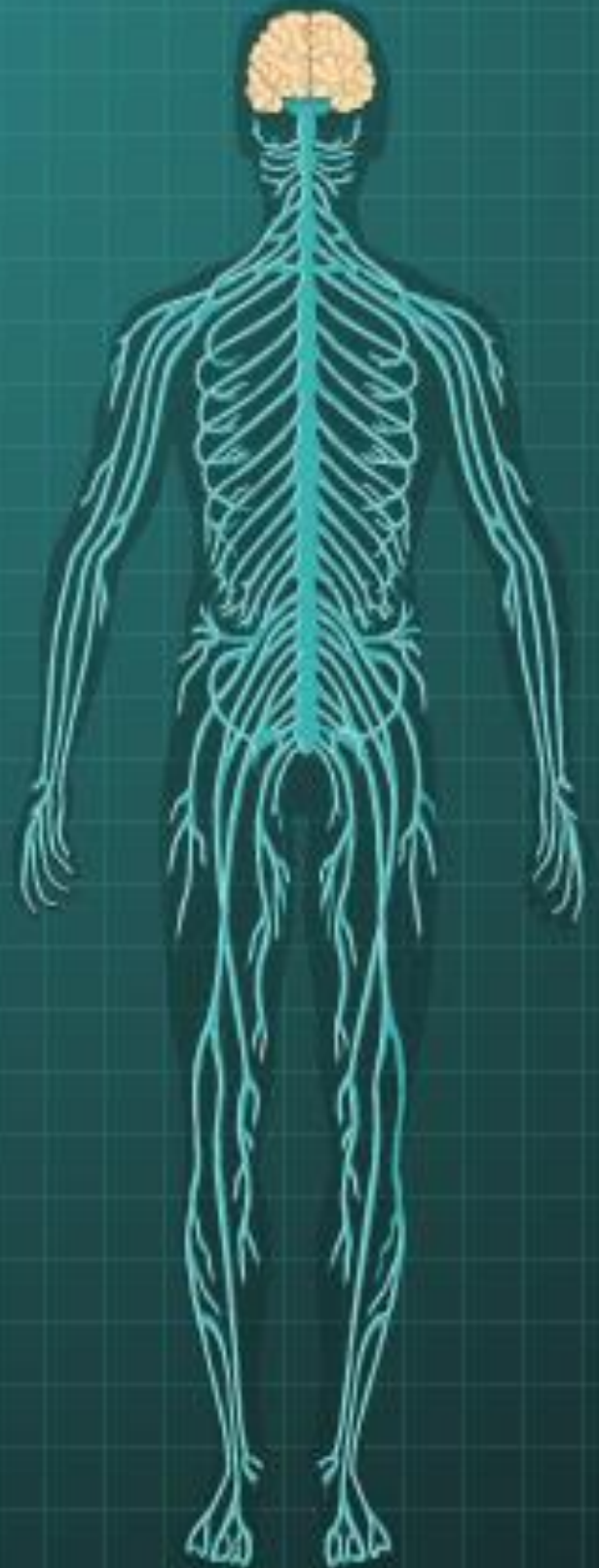

Service Functions

- **Cardiovascular system**
- Respiratory system
- Digestive system
- Renal system
- Reproductive system
- Musculo-skeletal system
- Nervous system
- **Endocrine system**
- Immune system

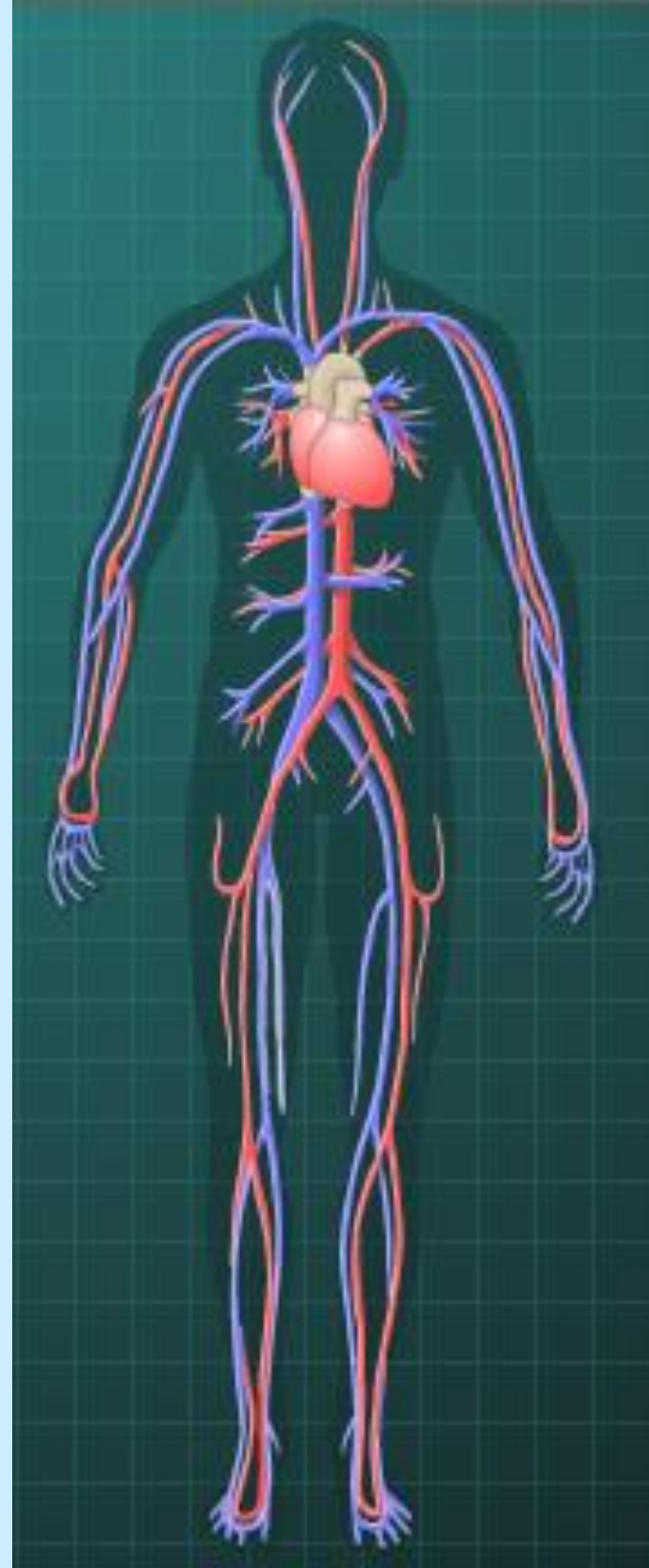

Service Functions

- Cardiovascular system
- Respiratory system
- Digestive system
- Renal system
- Reproductive system
- Musculo-skeletal system
- Nervous system
- Endocrine system
- **Immune system**

Any system missing?



Functions of Organ Systems

Integumentary - protection and temperature control.

Skeletal - support, protection, mineral storage, blood formation.

Muscular - locomotion, support, heat production.

Nervous - responding to stimuli and coordinating the activities of other organ systems, cognition, planning, consciousness, socializing

Endocrine - directing long-term changes in the activities of other organ systems.

Cardiovascular - internal transportation.

Lymphatic - defense against infection & disease.

Respiratory - delivery air to where gas exchange occurs.

Digestive - processing of food and absorption of nutrients, minerals, vitamins, and water.

Urinary - elimination of excess water, salts, and waste products.

Reproductive - production of sex cells & hormones.

If an alien animal fell on earth... what would it look like?

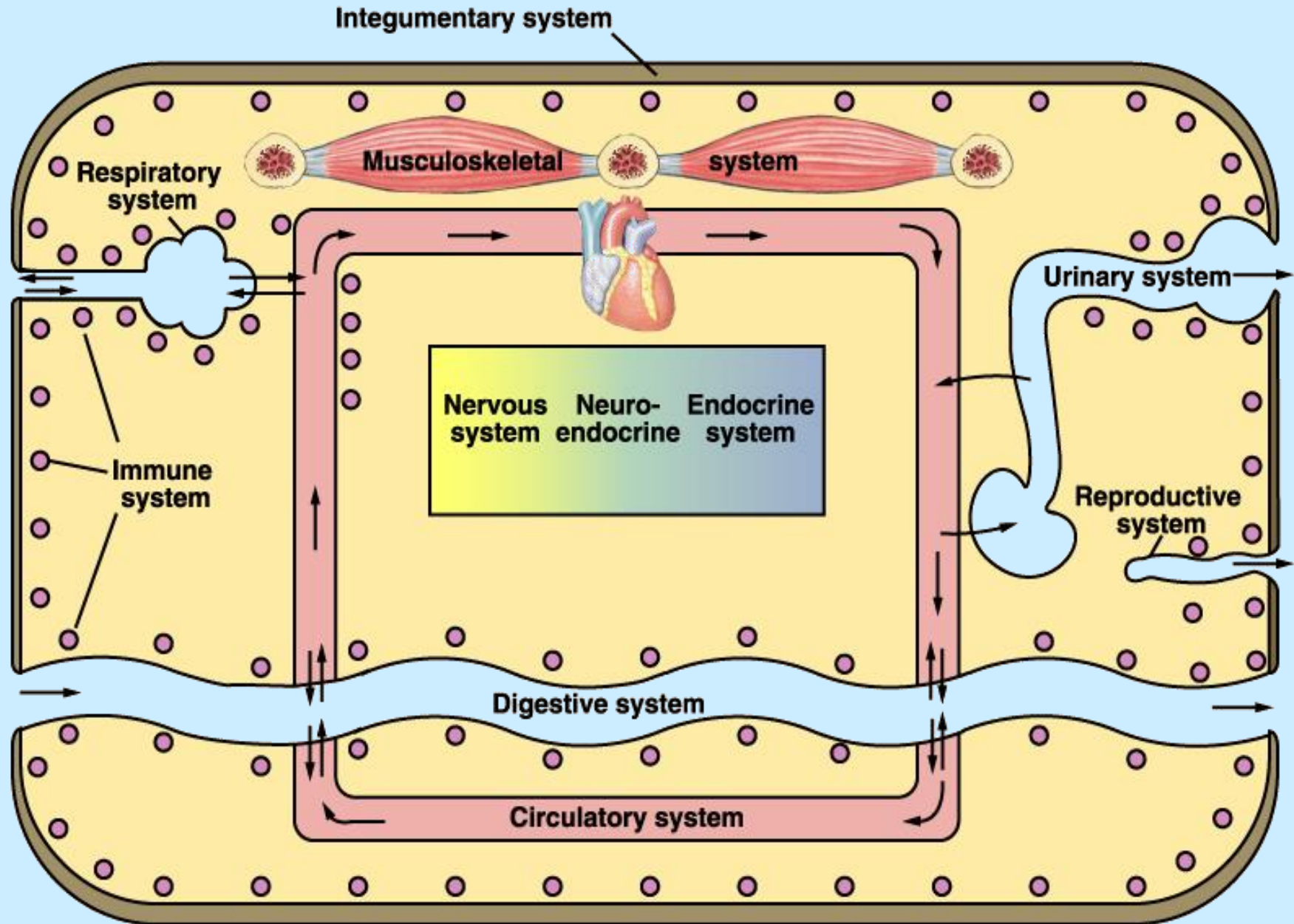

..a hint of integration?

Organisms are made up of systems, which are made up of organs

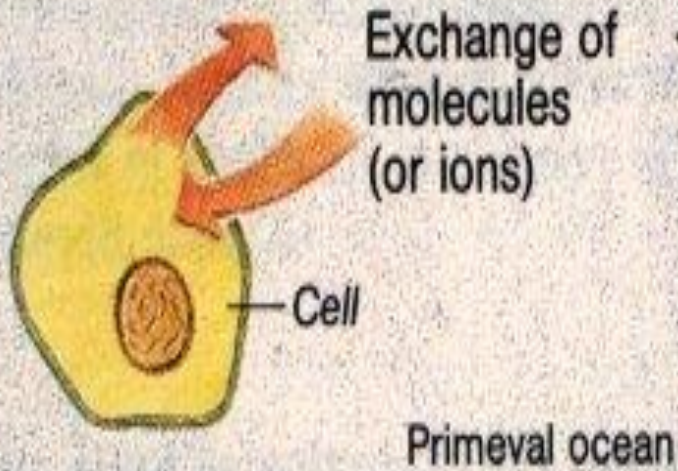

1. Unicellular organism

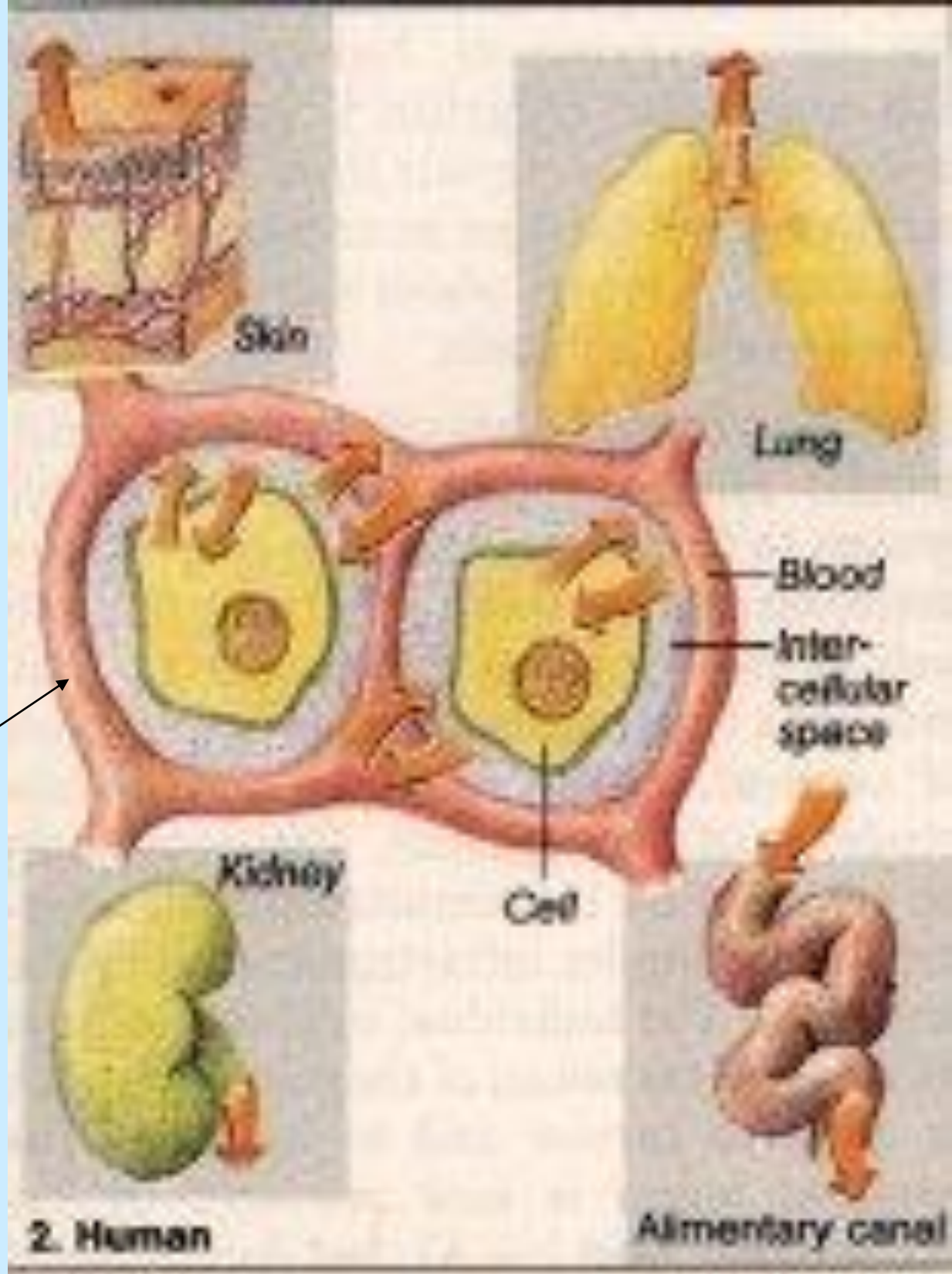

Cardiovascular

External
to Internal
environment

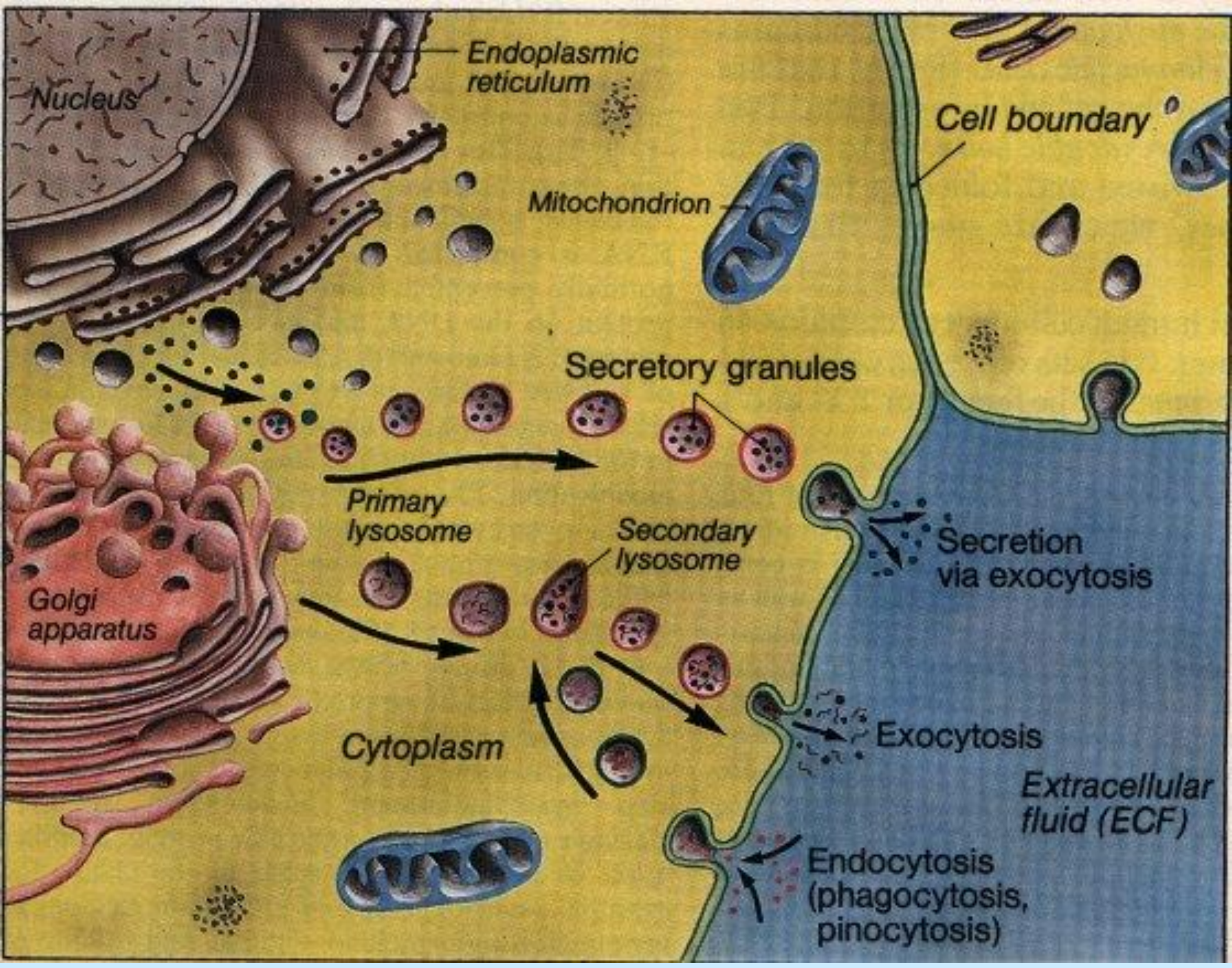

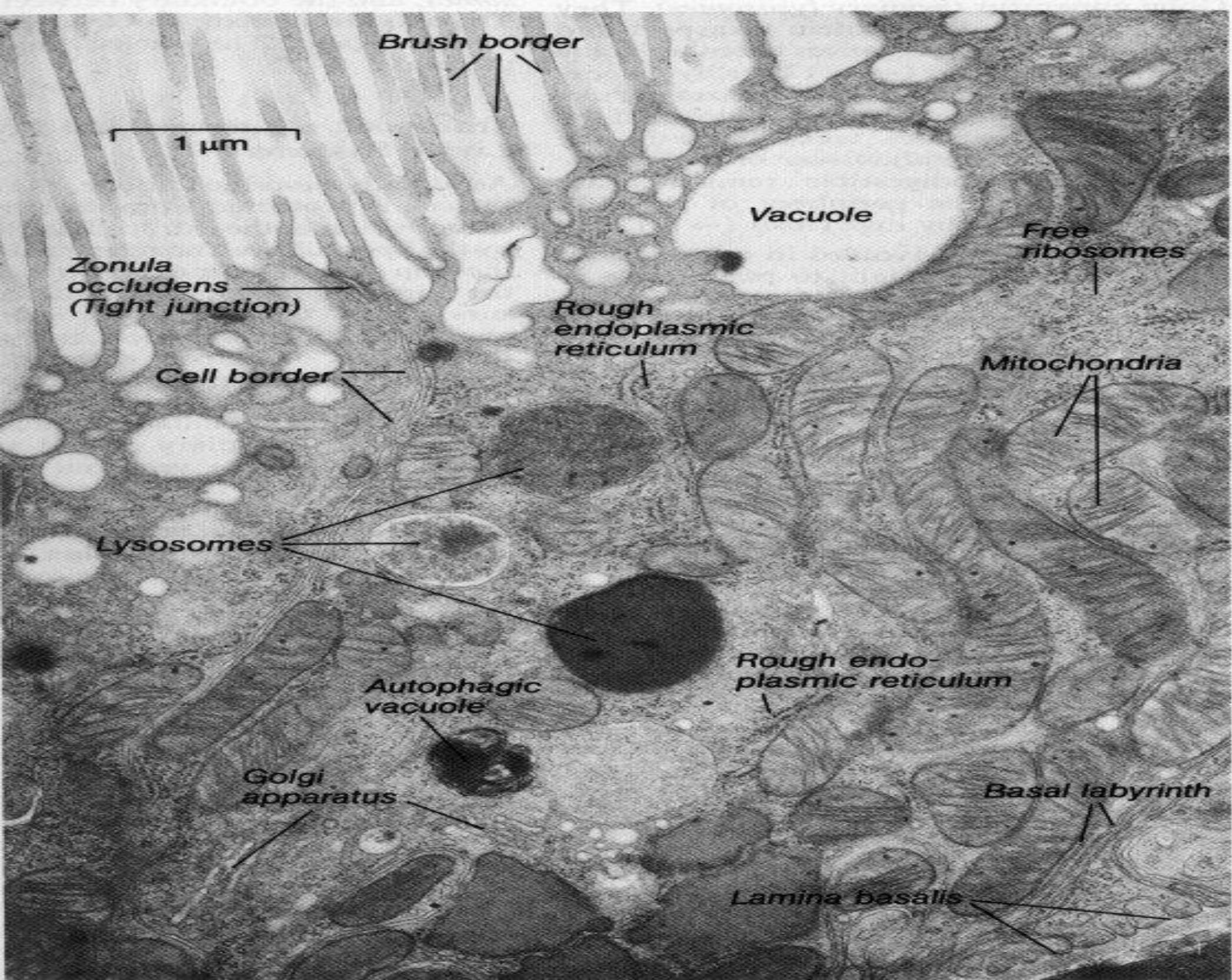

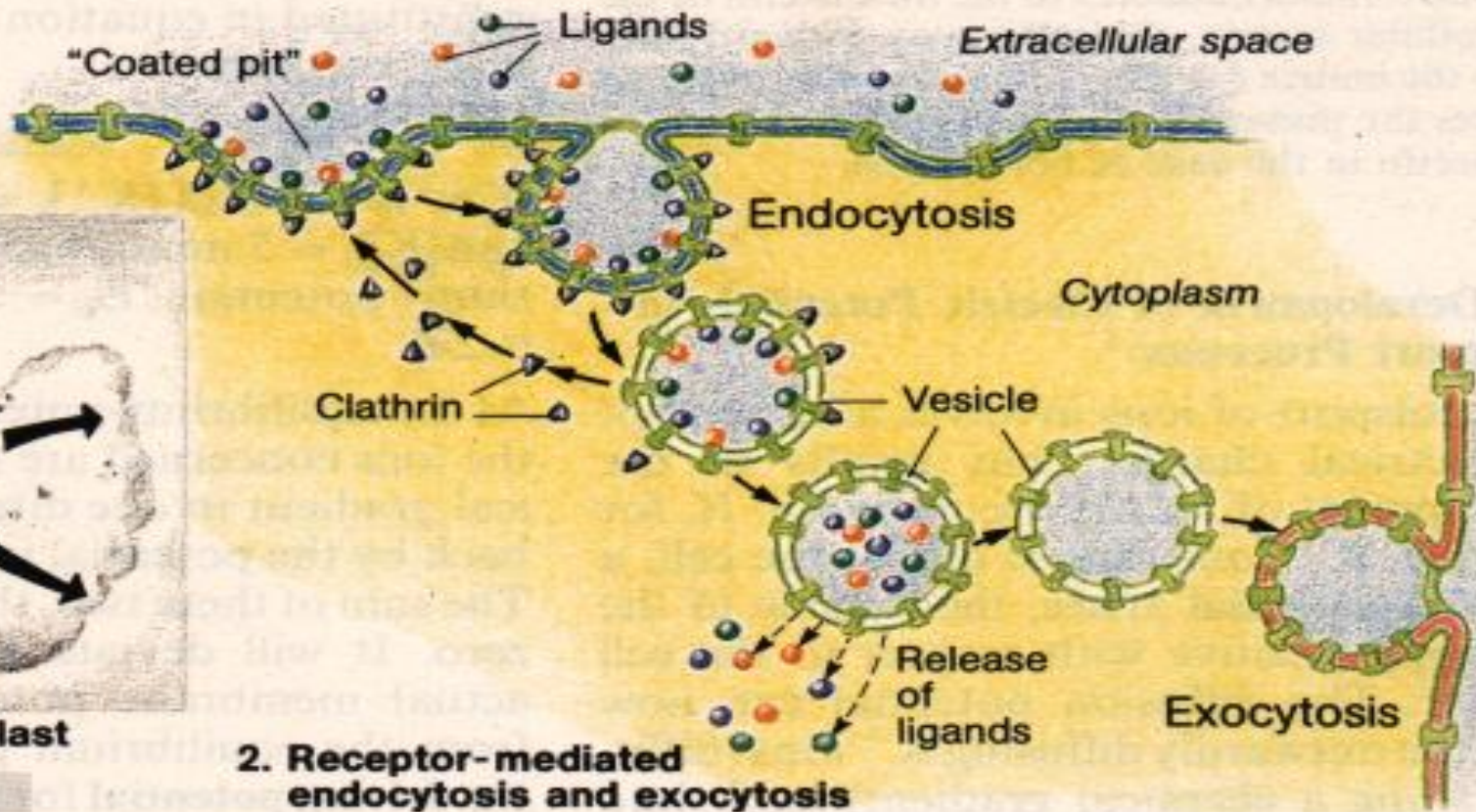

1. "Crawling" fibroblast

Intracellular membrane exchange (vesicle)

Endocytosis at the back

2. Receptor-mediated endocytosis and exocytosis

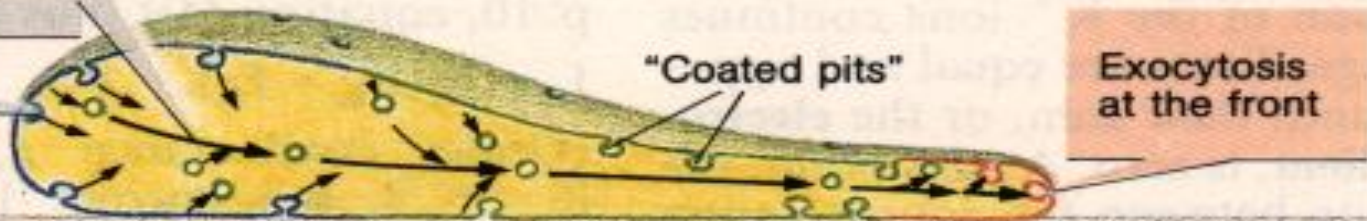

3. Locomotion

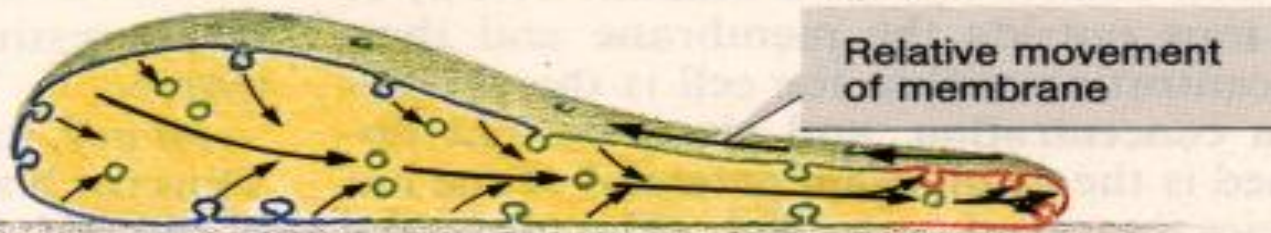

Physiology is quantified by BIOMETRICS

During the minute that it will take you to read this page:

Your eyes will convert the information on this page into electrical signals that will transmit to your brain.

Your heart will beat 70 times, pumping 5 liters of blood to your lungs and another 5 liters to the rest of your body.

Your kidneys will produce 1 ml of urine.

Your digestive system will be processing your last meal for transfer into your bloodstream.

Your brain will send chemical messengers through your nerves to control your body.

You will breathe in and out about 12 times.

Your cells will consume 250 ml of oxygen and produce 200 ml of carbon dioxide.

You will use about 2 calories of energy.

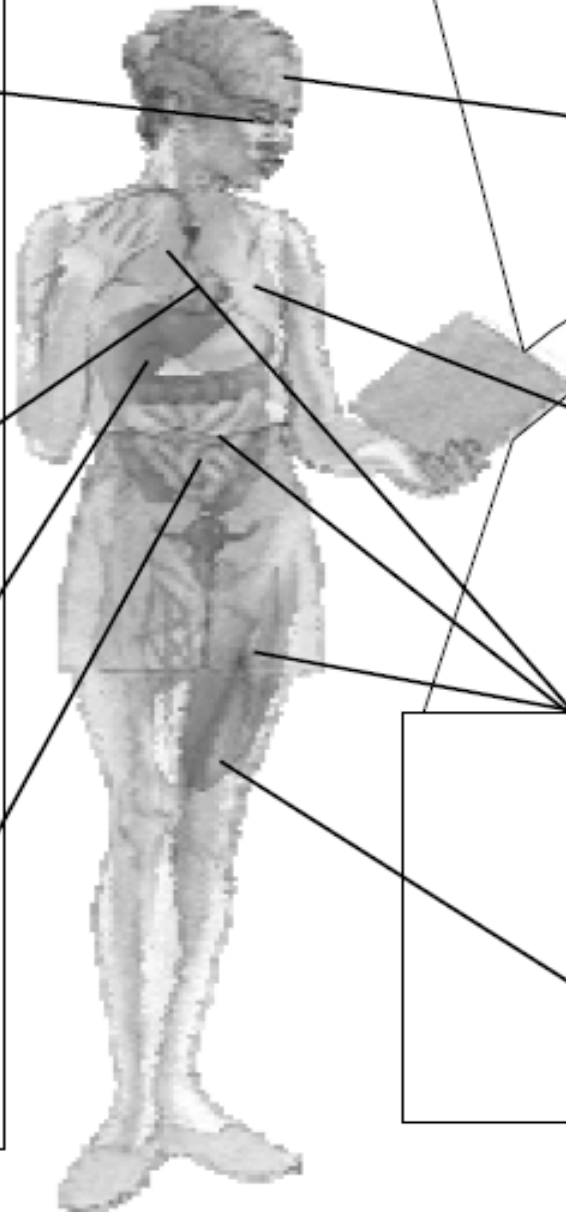

© 2000 Willamette University

Evolution of Physiological Systems

As life crawled from the sea **on land**, adaptations evolved to cope with changes in the external environment.

- Water conservation – skin, lungs, kidneys.
- Fertilization and fetal development.
- Skeletons to support body weight.
- ...
- ...
- **Locomotion** increased the need for better brains.

Why?

- **Raising kids** rather than laying eggs made necessary the development of what?

... so much about Physiology in general...

...More specifically ...

... Physiology tries to answer 3 principal questions:

- mechanisms maintaining **homeostasis**
- // of intra- & inter-cellular **communication**
- **energy** management in a body.

Θέματα-κλειδιά στη Φυσιολογία

- 1. Ομοιόσταση:** Διατήρηση των παραμέτρων του εσωτερικού περιβάλλοντος εντός στενών ορίων. Τα συστήματα στο σώμα μας συνεργάζονται ώστε να προστατεύουν την ομοιόσταση από εσωτερικές και εξωτερικές προκλήσεις
- 2. Επικοινωνία:** (από το ενδοκυττάριο και διαμεμβρανικό επίπεδο μέχρι εκείνο του οργανισμού) Είναι ζωτικής σημασίας στην σύνθεση και ολοκλήρωση των λειτουργιών και στην ομοιόσταση. Κύτταρα επικοινωνούν με άλλα κύτταρα, ιστούς και όργανα
- 3.** (Διαμερισματοποίηση του σώματος και του κυττάρου και) **Ροή ενέργειας** και διατήρηση της μάζας

Key subjects in Physiology

- 1. Homeostasis**
- 2. Communication**
- 3. Energy**

Internal Versus External Environment

Most cells in the human body are not in contact with the external environment.

Extracellular fluid (ECF) – body fluid that surrounds the cells and makes up one-third of the body's total volume.

Intracellular fluid – inside cells. Contains bulk of body's water.

ECF serves as interface between external environment and cells. Maintained within a narrow range of values.

External environment

**Material enters
and leaves
the body**

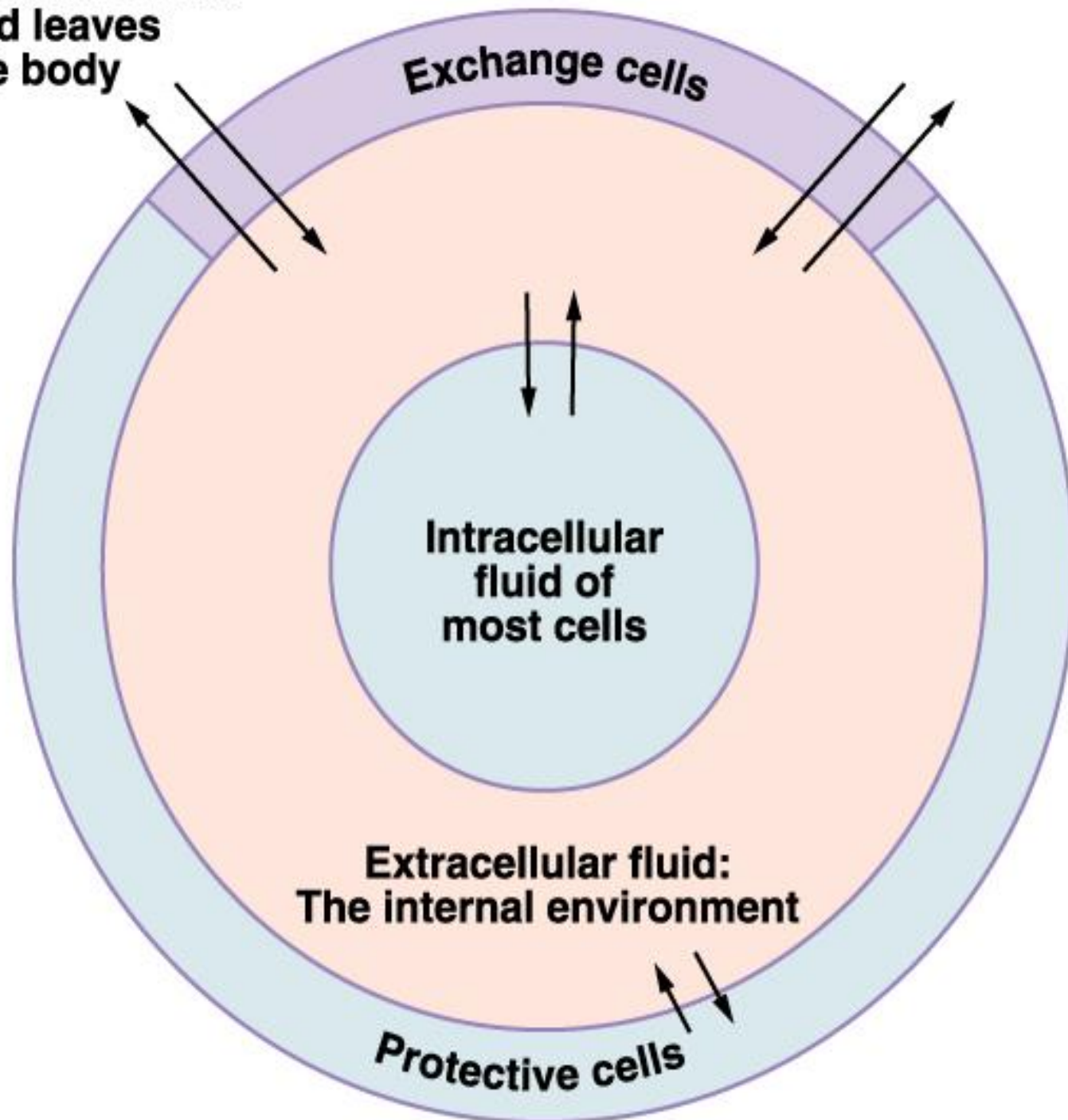

Exchange cells

**Intracellular
fluid of
most cells**

**Extracellular fluid:
The internal environment**

Protective cells

Homeostasis is ...

- ... the process of maintaining the composition of the internal body compartments within fairly strict limits (i.e. ion concentrations, pH, osmolarity, temperature etc)
- ... requires regulatory mechanisms to defend against changes in external environment and changes due to activity
- Cellular homeostasis - ... of the intracellular fluid composition
- Organismal homeostasis - ... of the extracellular fluid composition
- Cardiac muscle cell contraction = electrical signals \Rightarrow changes in intracellular and extracellular $[Na^+]$, $[K^+]$ and $[Ca^{2+}]$
- If extracellular $[K^+]$ too high \Rightarrow depolarisation \Rightarrow contraction \Rightarrow fibrillation (bag of worms, ταχυαρρυθμία) \Rightarrow risk of death

CONCLUSION: Extracellular $[K^+]$ must be kept within narrow range

Homeostasis in Summary

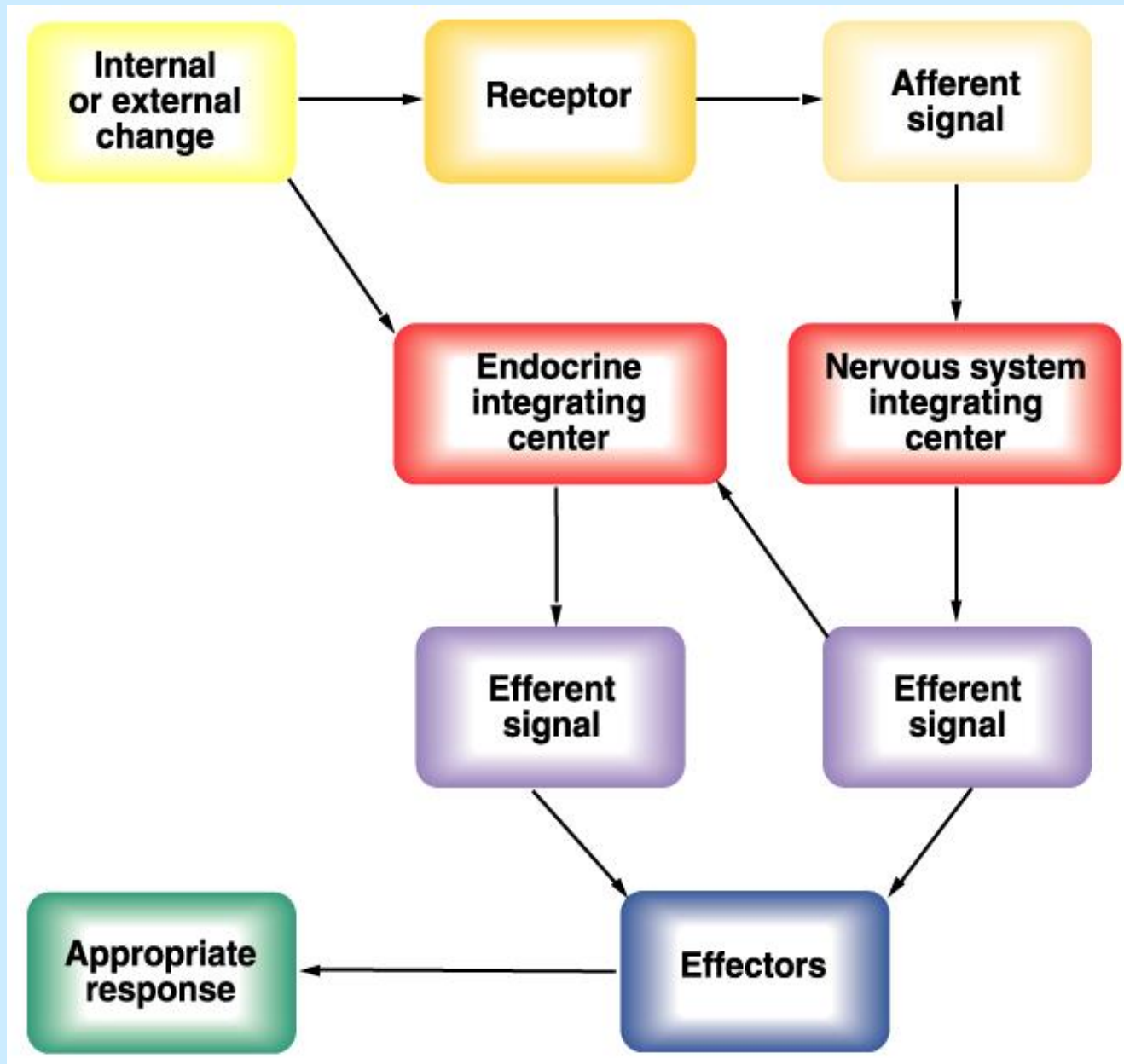

Theory

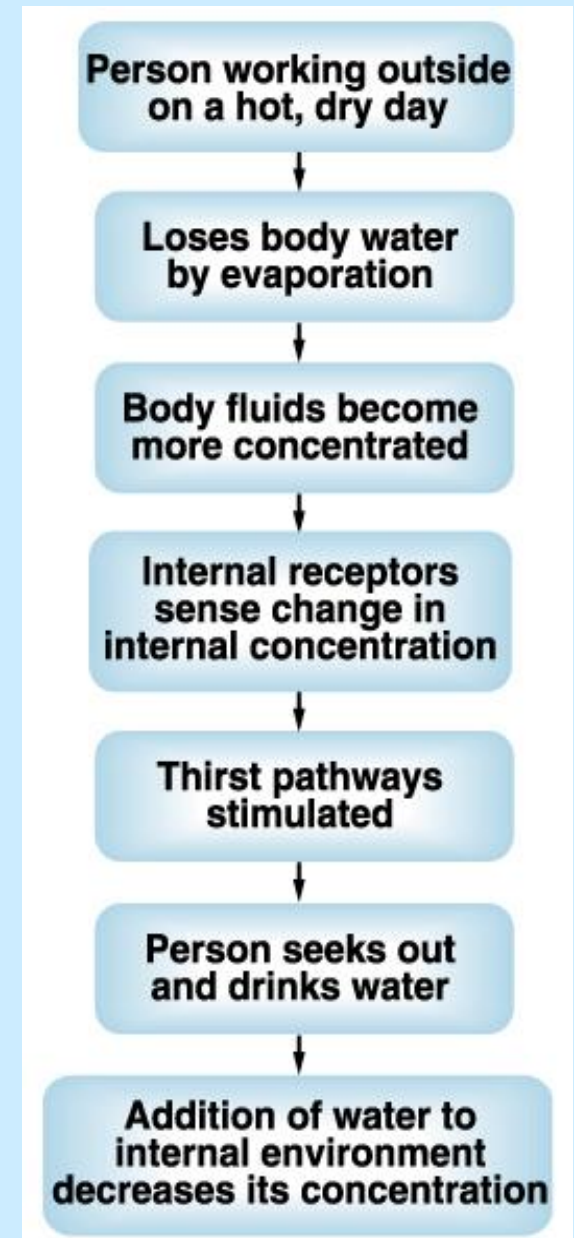

Praxis

Homeostasis

The maintenance of a relatively constant internal environment.

ὁμοιος (same) + *στάσις* (a standing).

absence of homeostasis = disease!

Word created in 1929 by Walter B. Cannon.

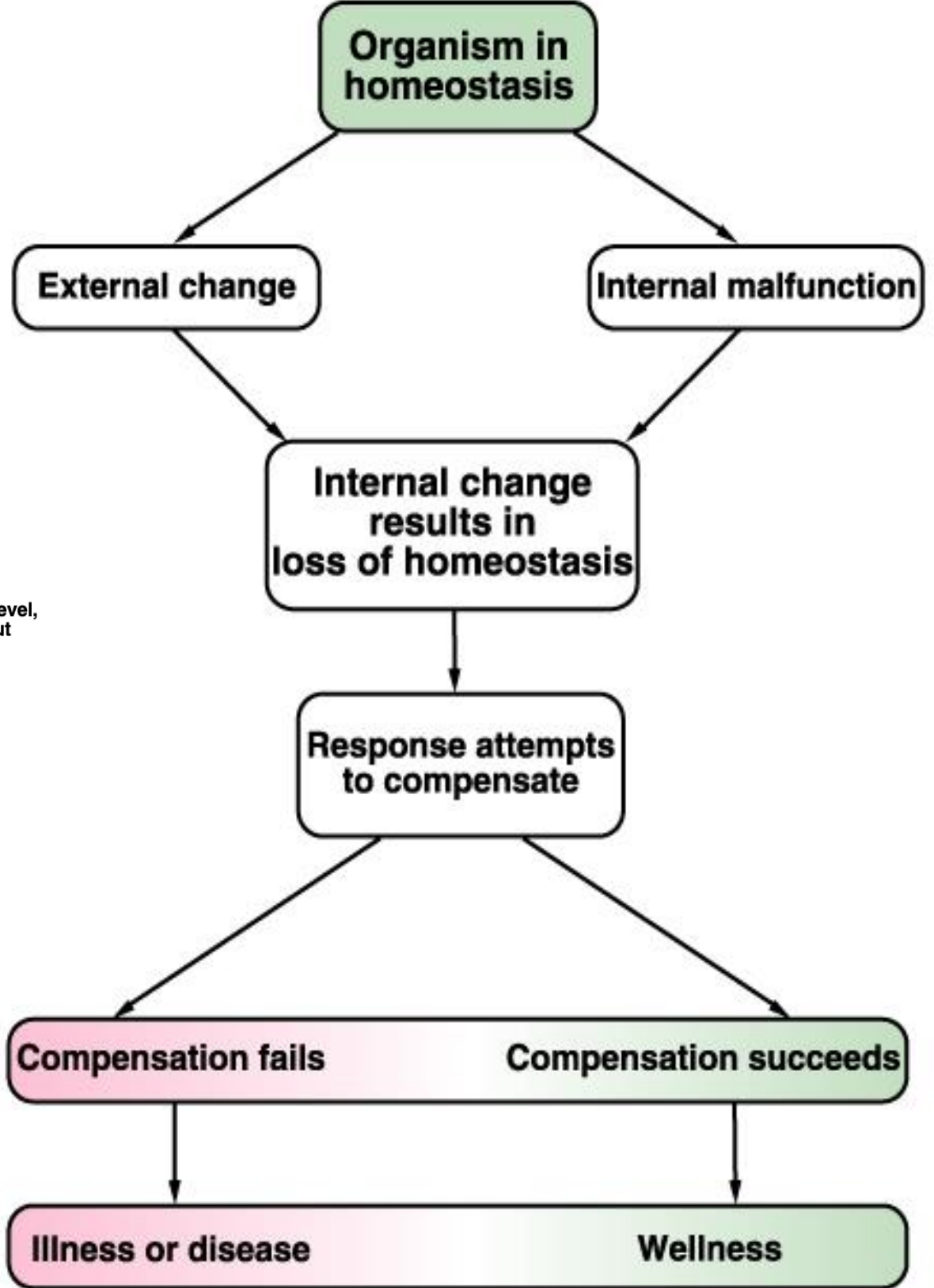
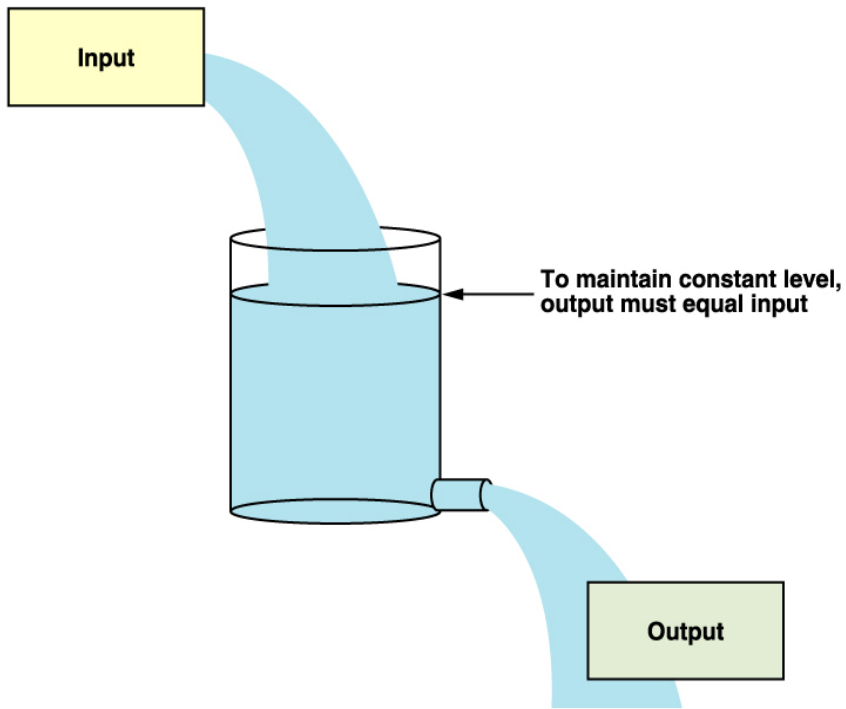

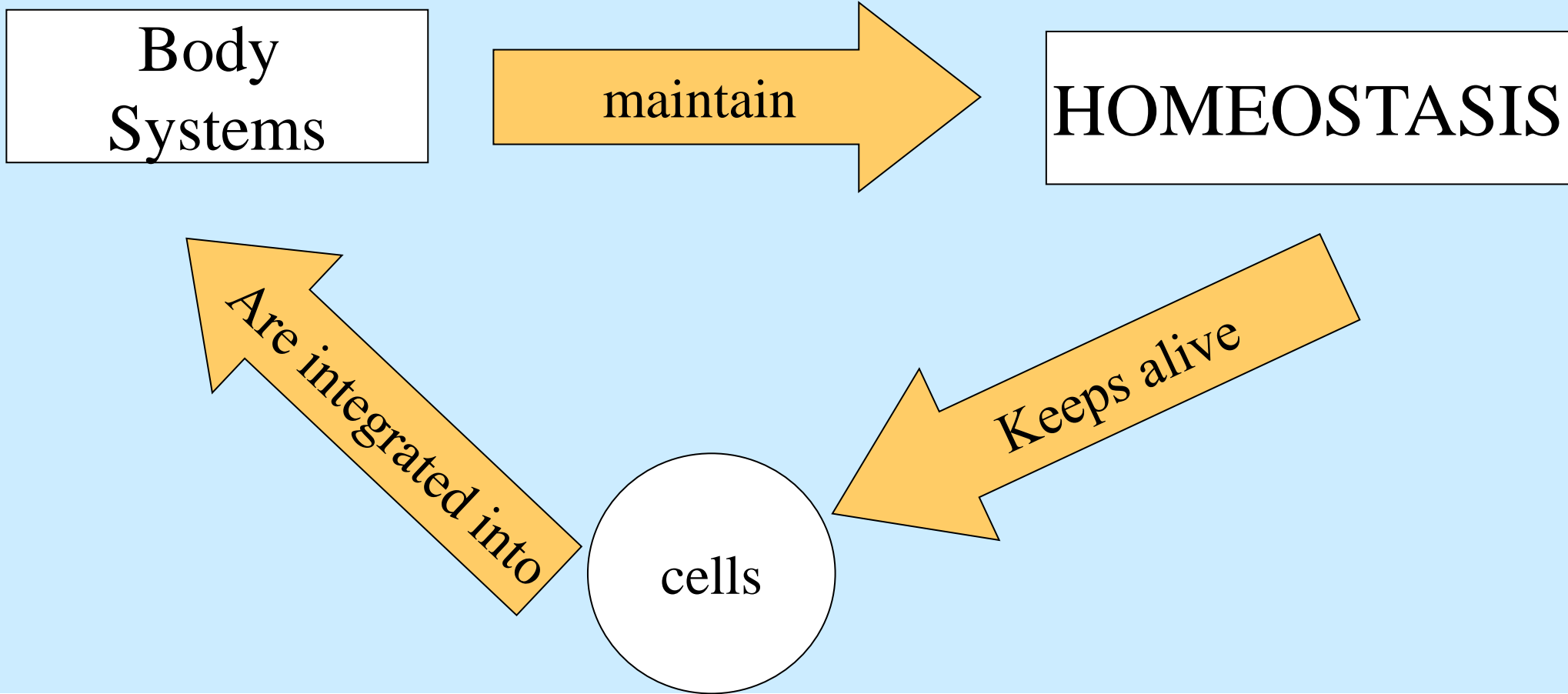

Cellular homeostasis \leftrightarrow body homeostasis

Homeostasis = maintenance of vital parameters of extracellular fluid within set limits

Components of an homeostatic system: receptors, control center, executors

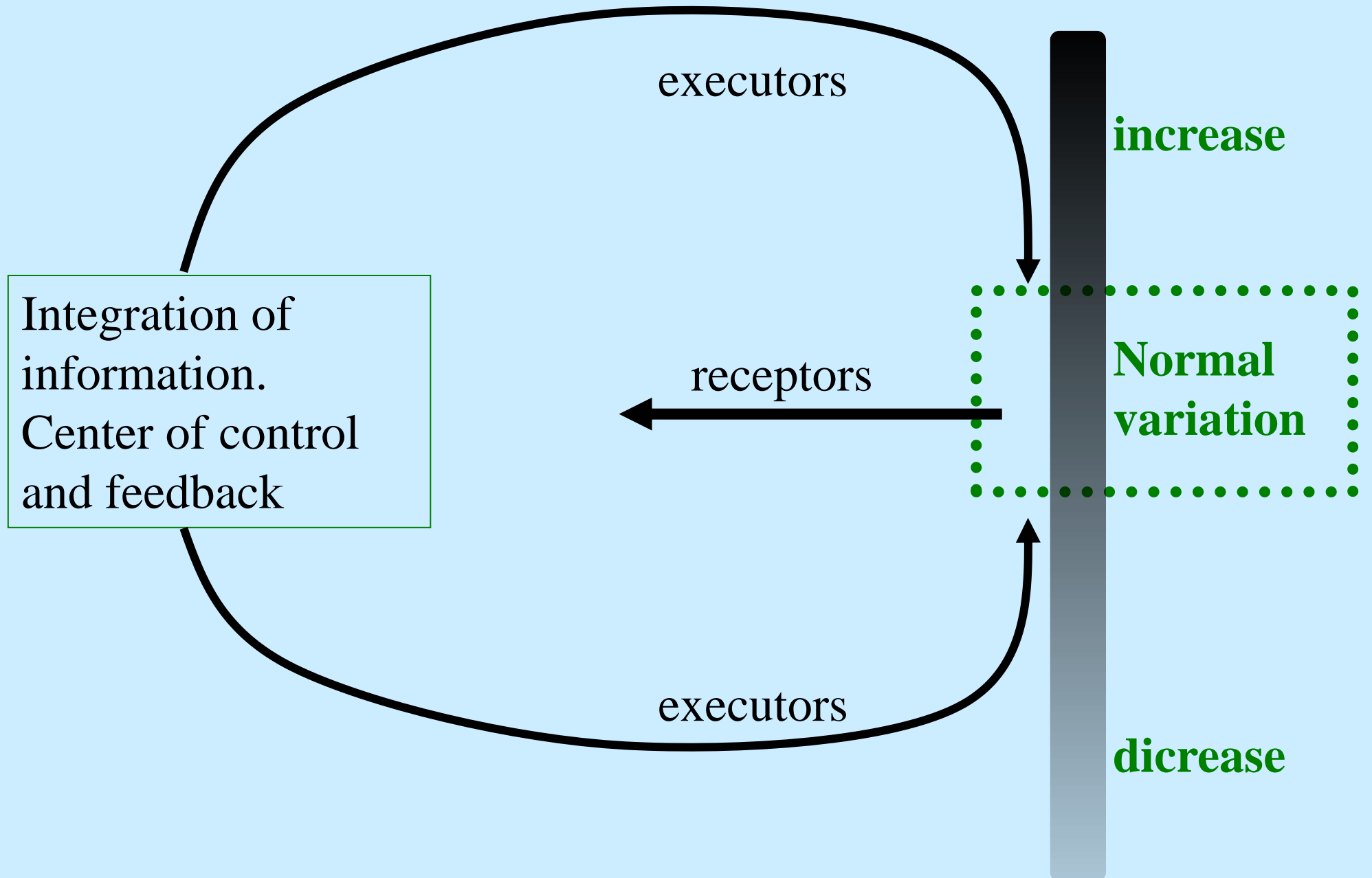

Responses to stimuli:

- **local** (paracrine and autocrine)
- **reflexive via remote centers** (neural, endocrine)

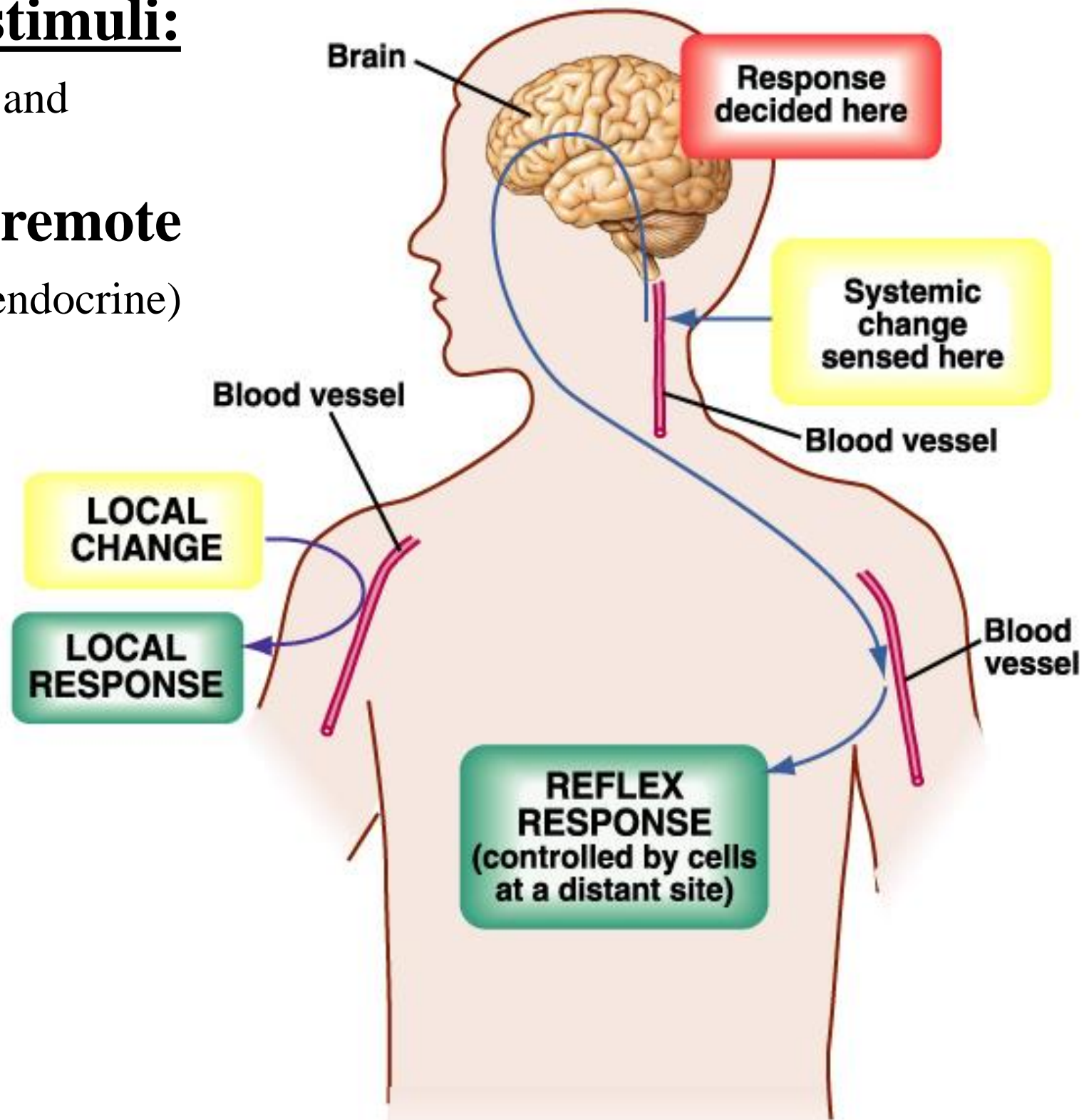

Receptors

Cell membrane or cytoplasmic receptor proteins



Specialized cells or structures for the transduction of various stimuli into electrical signals

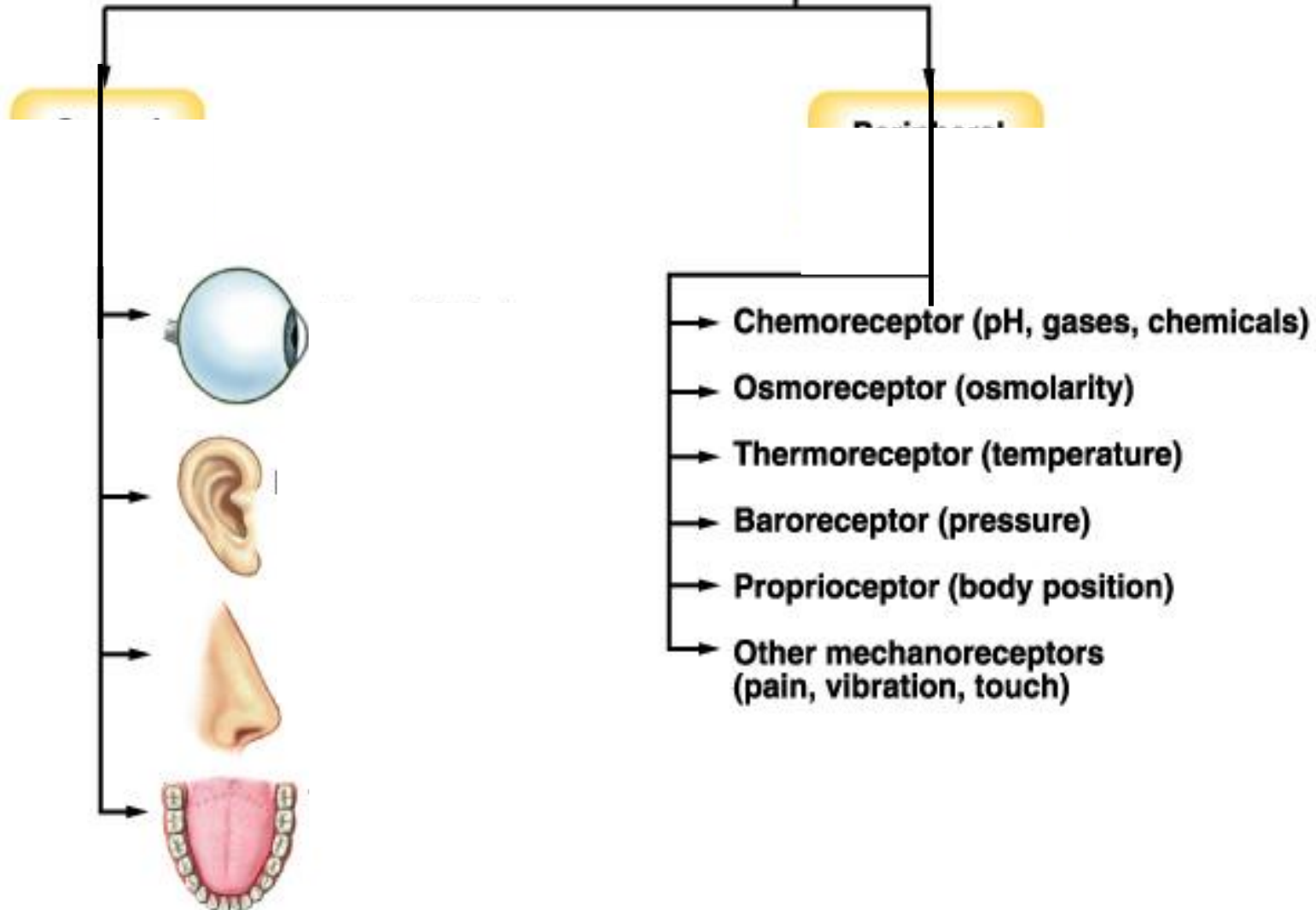



Penguins gather close to each other to face the cold.... We ?

MULTIPLE HOMEOSTATIC MECHANISMS CONTROL BODY TEMPERATURE

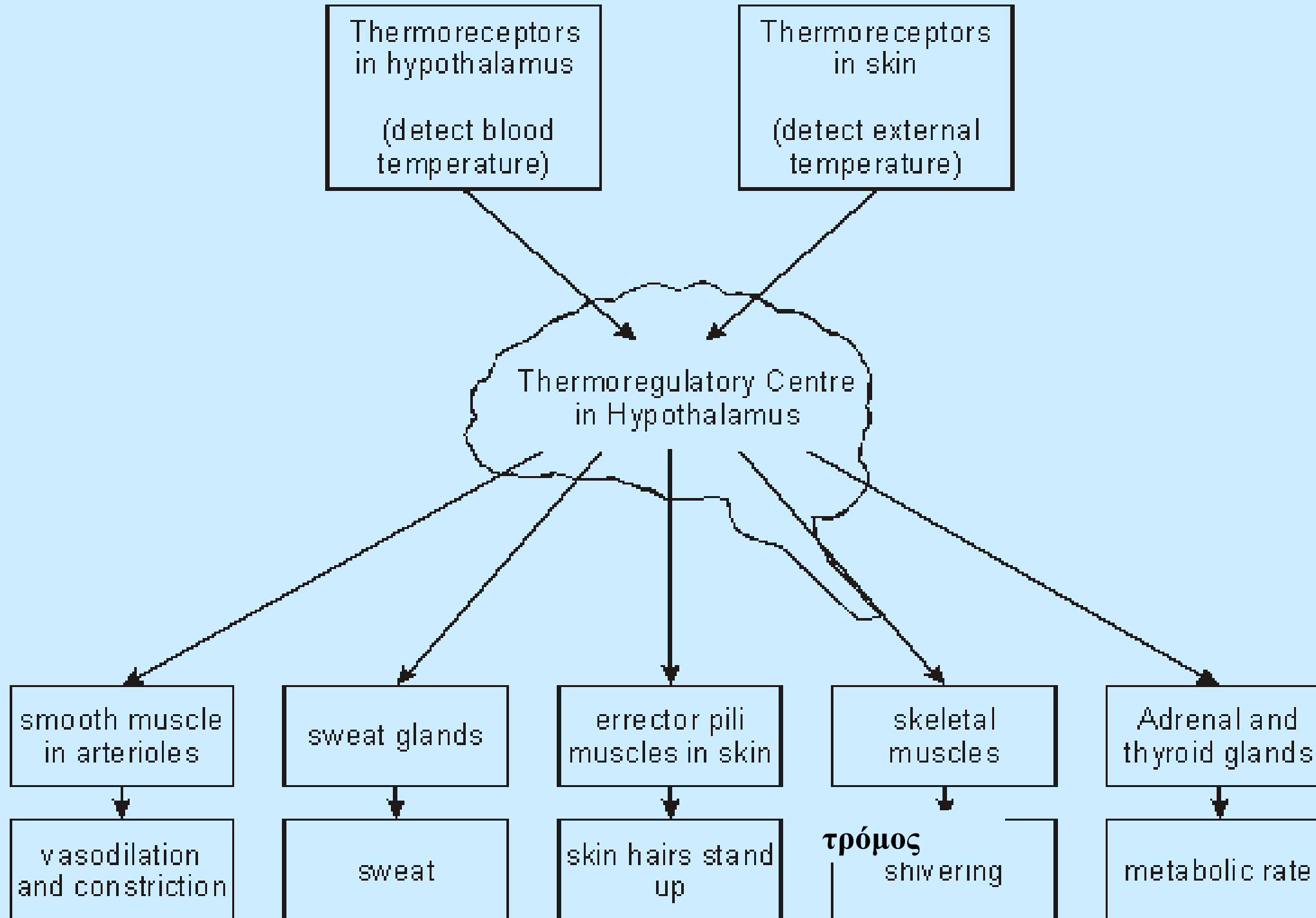

How is homeostasis achieved?

- Desired concentration range for each chemical constituent of body \Rightarrow regulatory mechanisms

eg

Blood [glucose] \approx 4-5 mmol.l⁻¹

if [glucose] \gg 5 mmol.l⁻¹ \Rightarrow \uparrow insulin secretion

\Rightarrow \downarrow [glucose]

if [glucose] \ll 4 mmol.l⁻¹ \Rightarrow \downarrow insulin secretion

\Rightarrow \uparrow [glucose]

ie [insulin]_{blood} changes to maintain [glucose]_{blood}

- Regulation termed - **NEGATIVE FEEDBACK**
- Control system designed to maintain level of given variable (concentration, temperature, pressure) within defined range following disturbance

glycogen

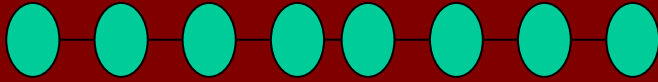

If sugar increase too much, insuline converts part of glucose to glycogen

insuline

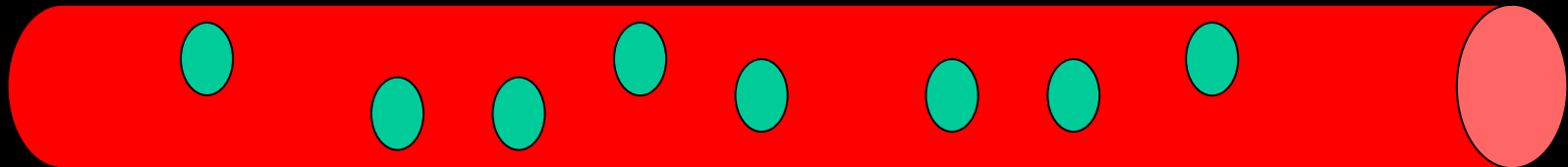

Blood glucose

glycogen

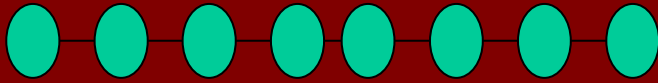

If glucose is decreased too much, glucagon converts part of glycogen to glucose



glucagon

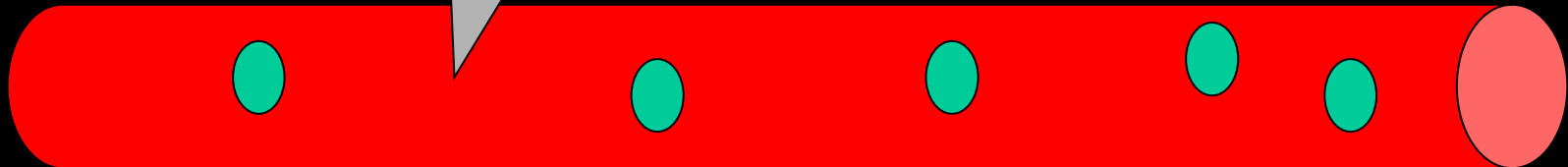

Blood glucose

glycagon

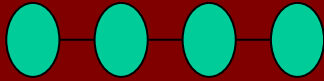

Without insuline
blood glucose
levels increase in
dangerous levels

~~insuline~~

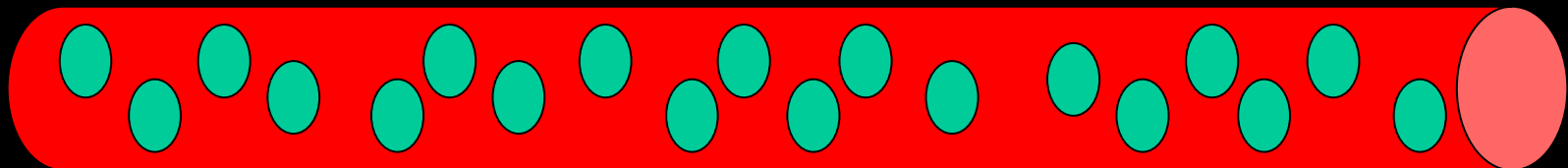

Blood glucose

Diabetes

- Some people do not produce enough insulin
- When they eat their blood glucose levels cannot be decreased
- This condition is called diabetes.
- Diabetic patients may need to have insulin injected in their blood. They have to control their diet.

Glucose concentration

Glucose levels increase after a meal

Insulin is produced and glucose levels return to normal

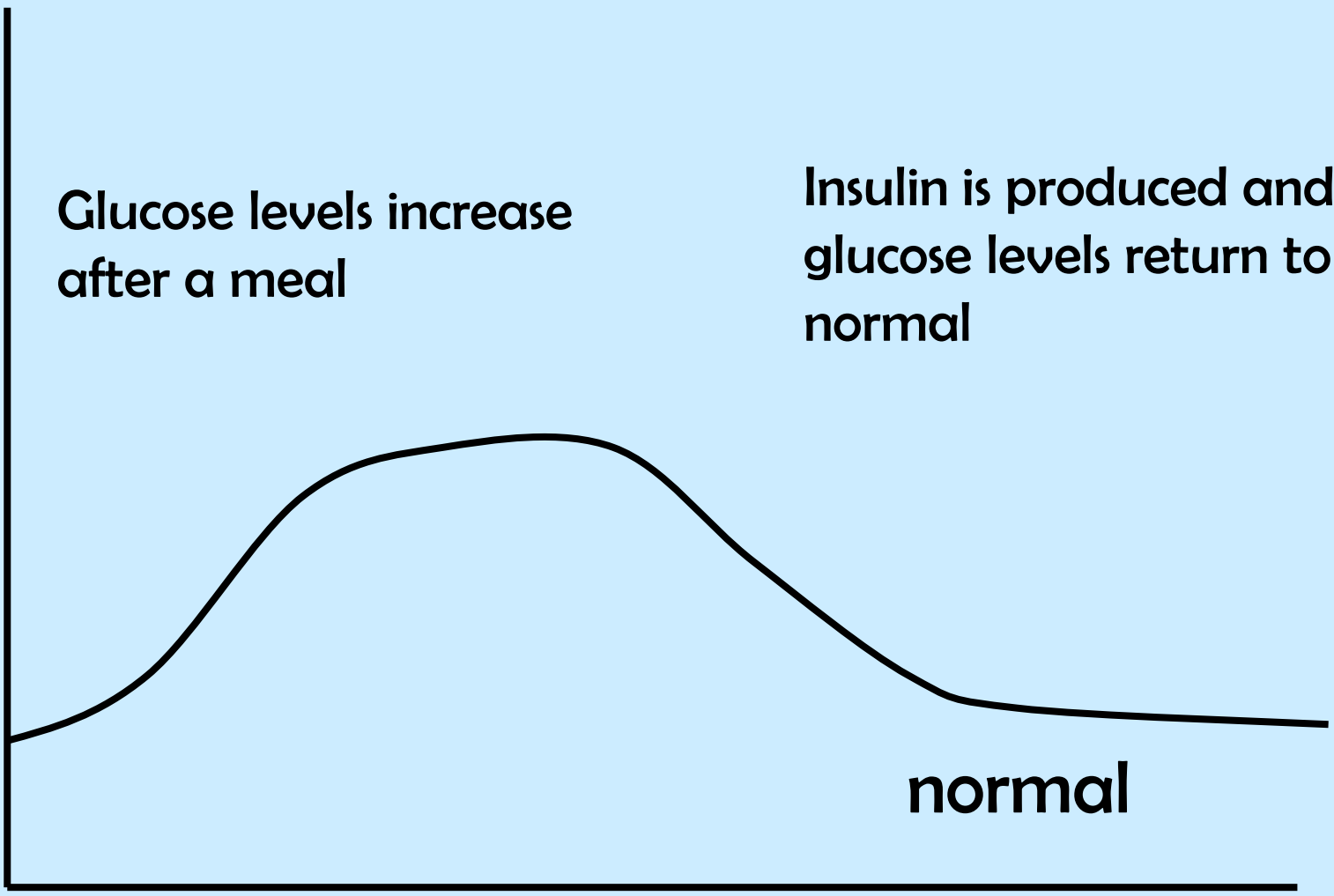

normal

time

meal

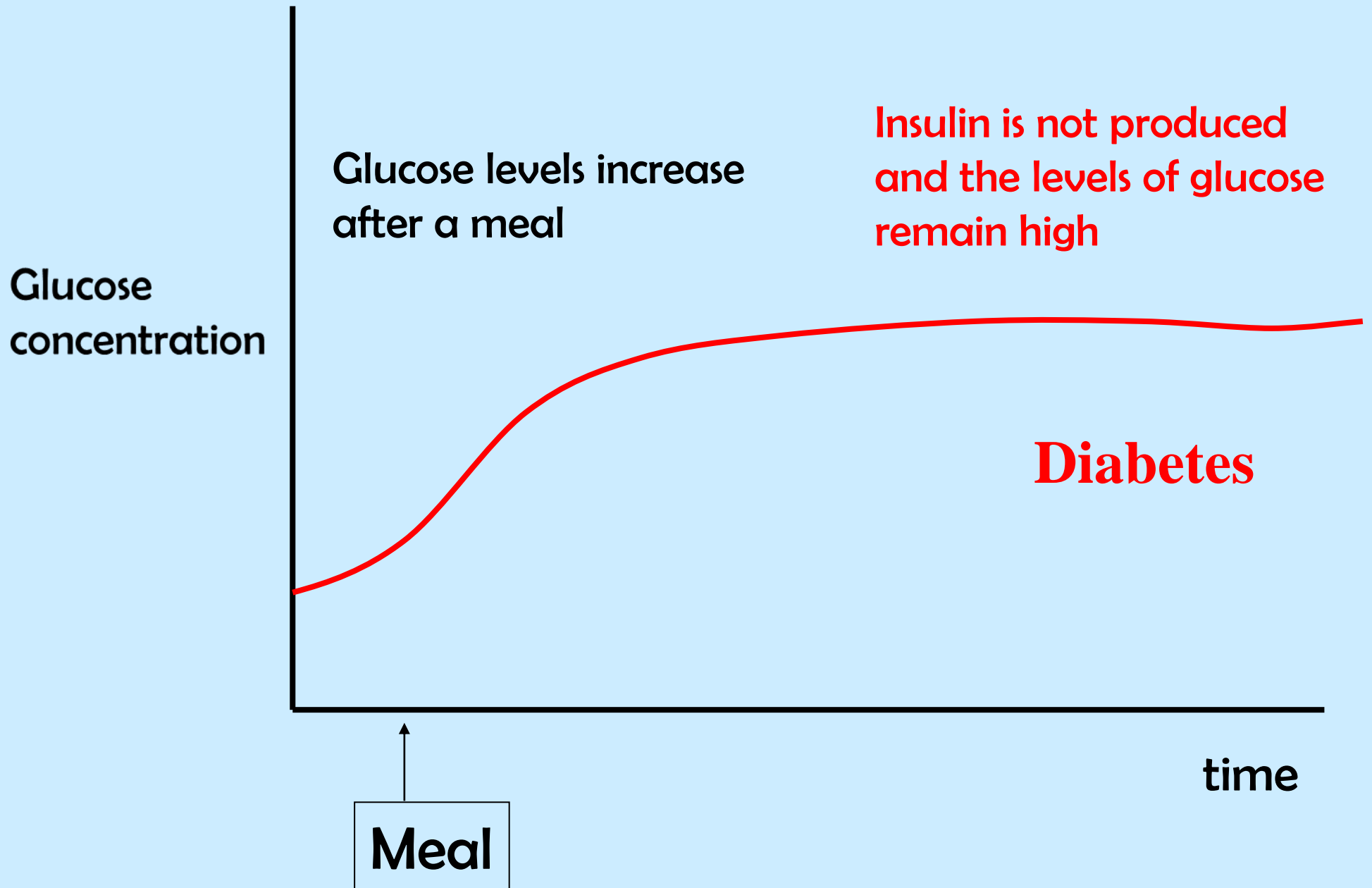

Negative feedback: controlling glucose blood levels

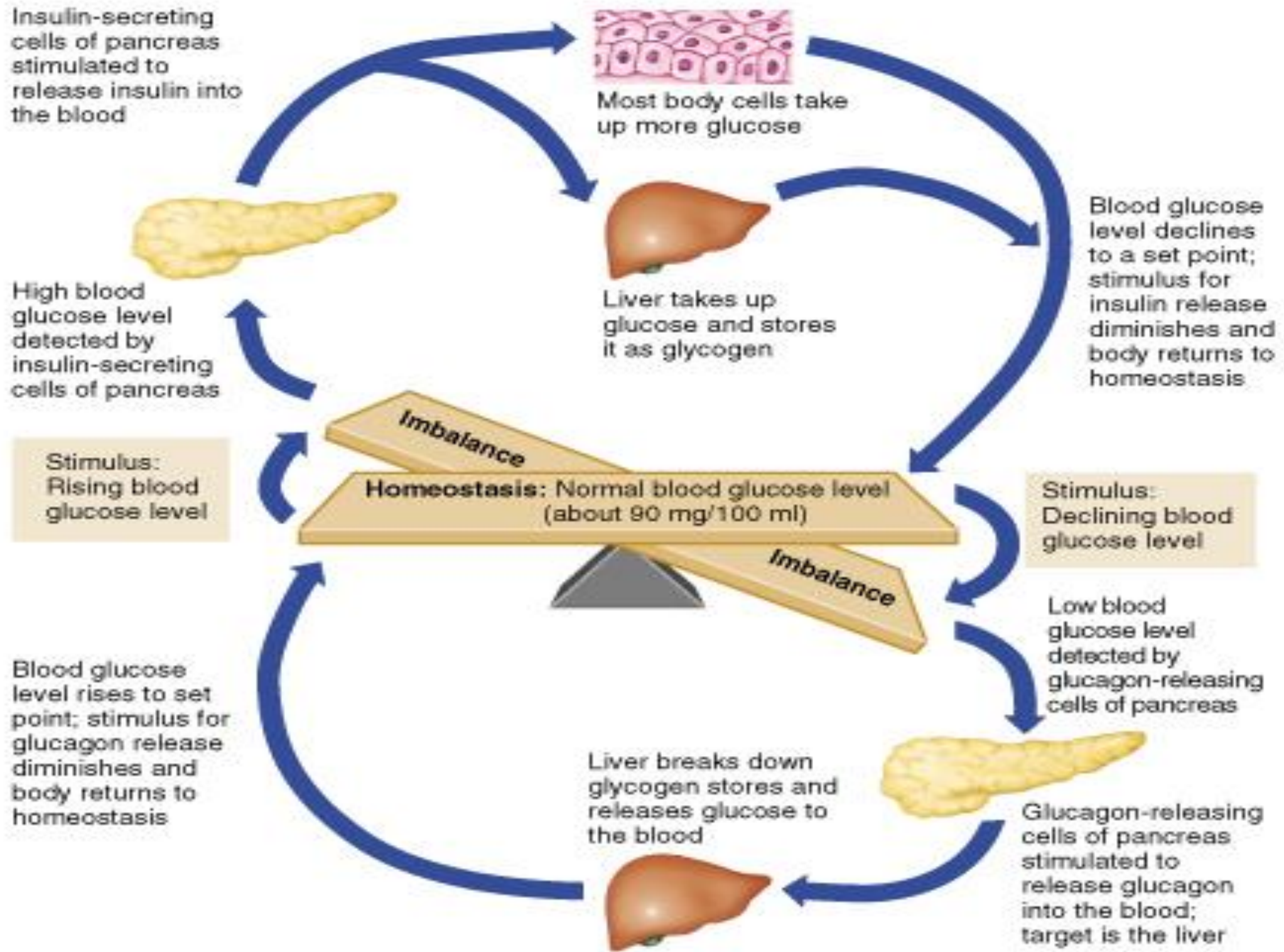

HOMEOSTASIS OF GLUCOSE

Delayed correction leads to oscillation

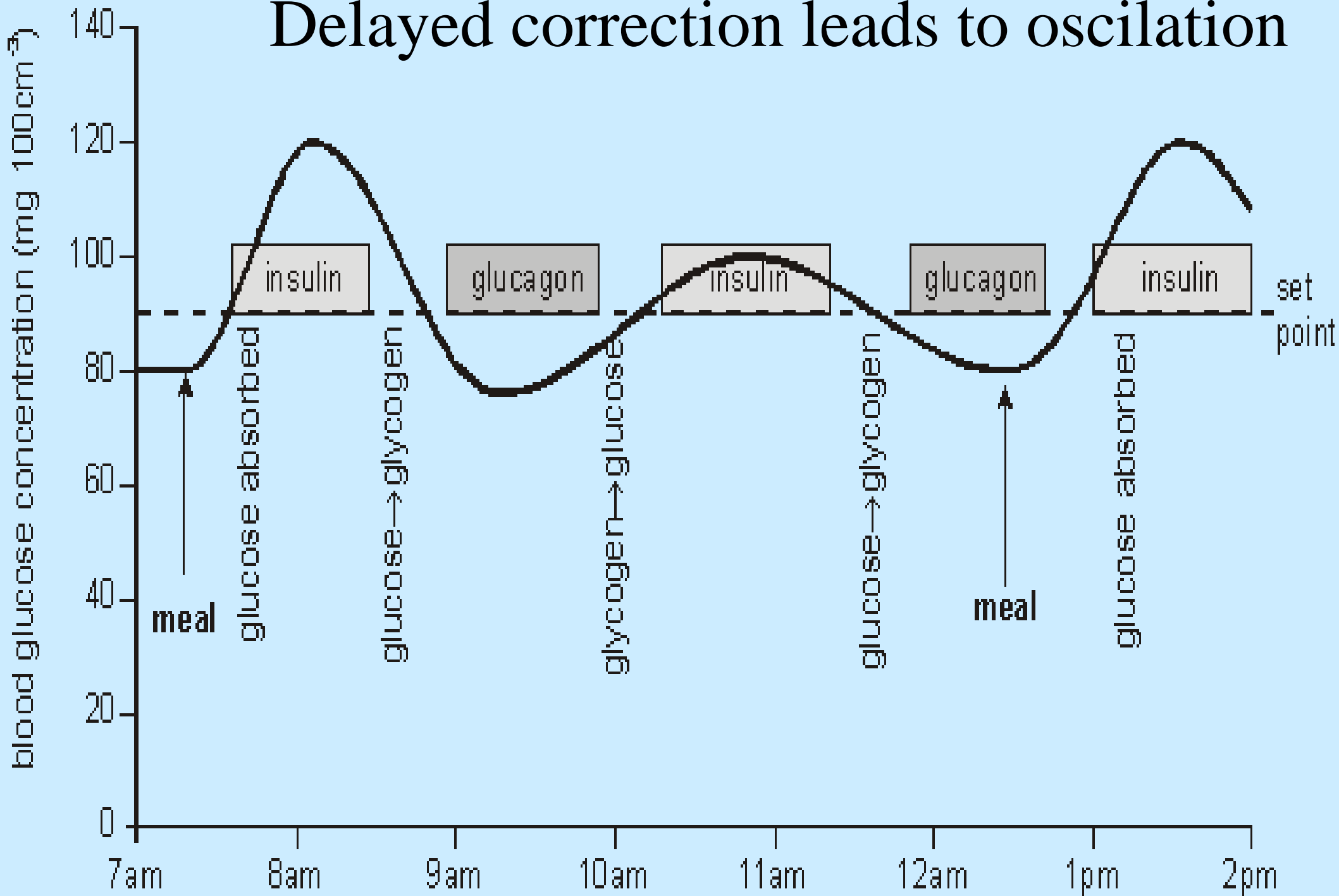

Negative feedback loop

Negative feedback loop requires:

Sensor specific to variable needing to be controlled

Comparator reference point for sensor to compare against

Effector if sensor \neq comparator \Rightarrow **Error Signal** \Rightarrow restore variable to desired level

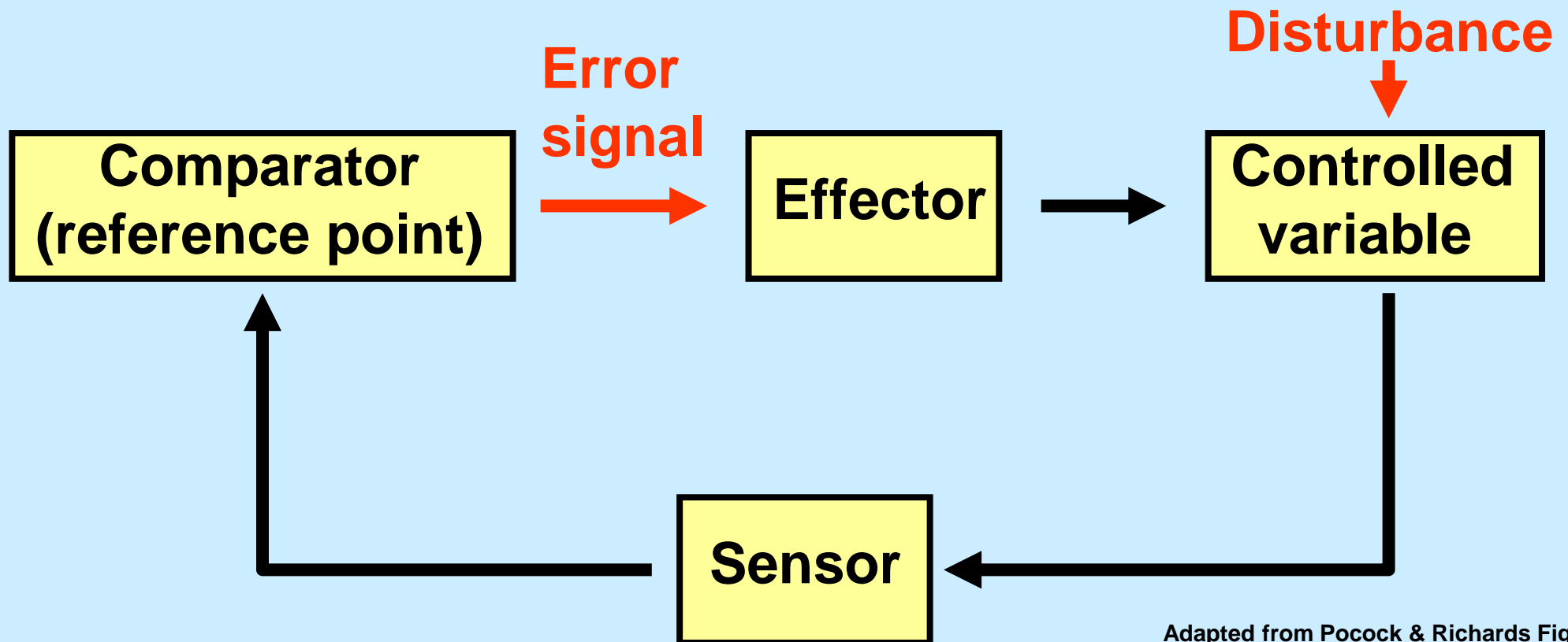

Limitations of negative feedback

- Negative feedback control initiated *after* variable has been disturbed
- Amount of correction to be applied assessed by magnitude of error signal \Rightarrow incomplete correction
- Overcorrection \Rightarrow oscillations in controlled variable
- Disadvantages overcome by multiple regulatory mechanisms

eg

regulation of blood [glucose]

insulin \Rightarrow \downarrow [glucose]_{blood}

glucagon \Rightarrow \uparrow [glucose]_{blood}

Organs included in Ca^{++} homeostasis and daily cycle of its levels

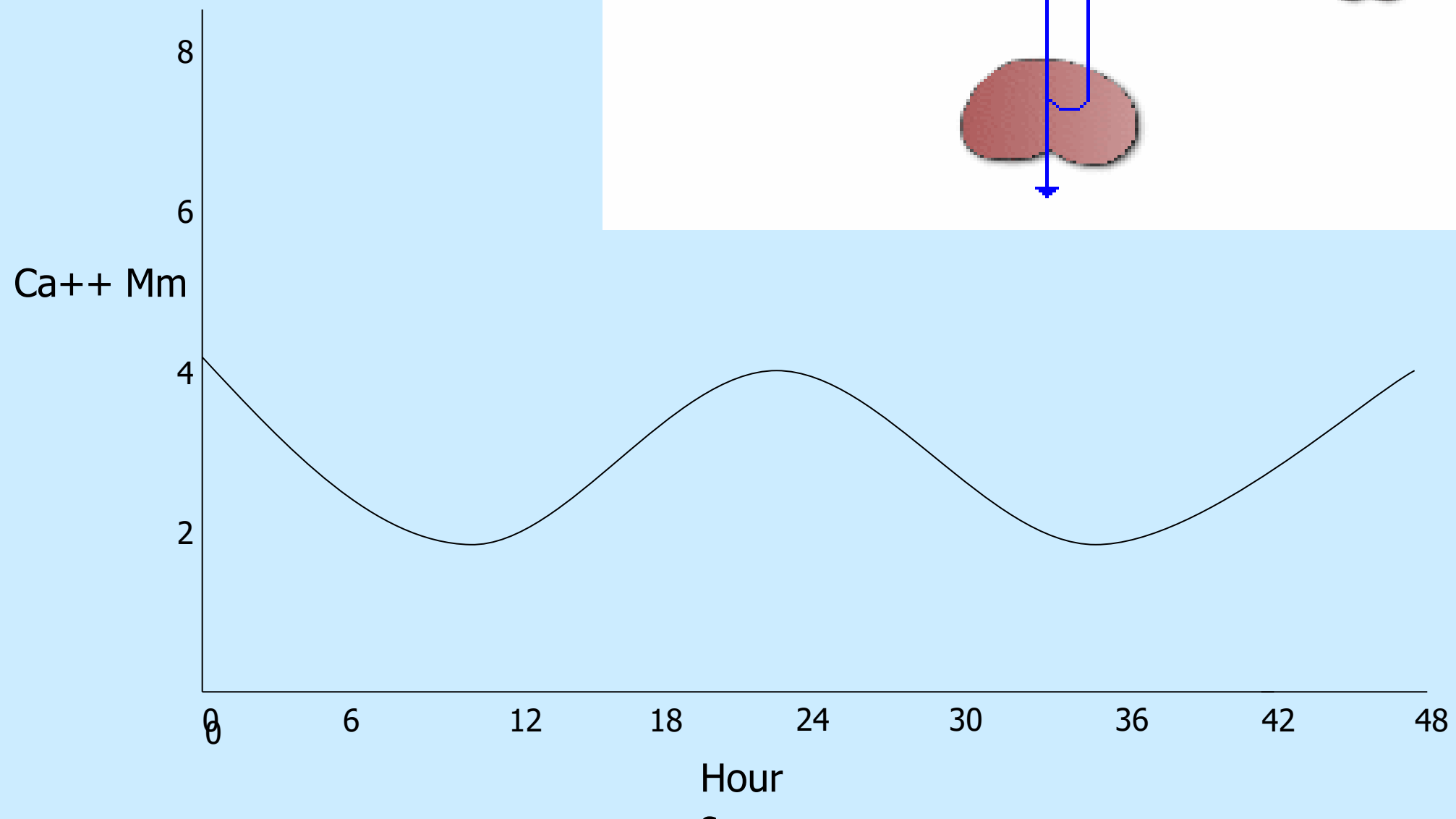
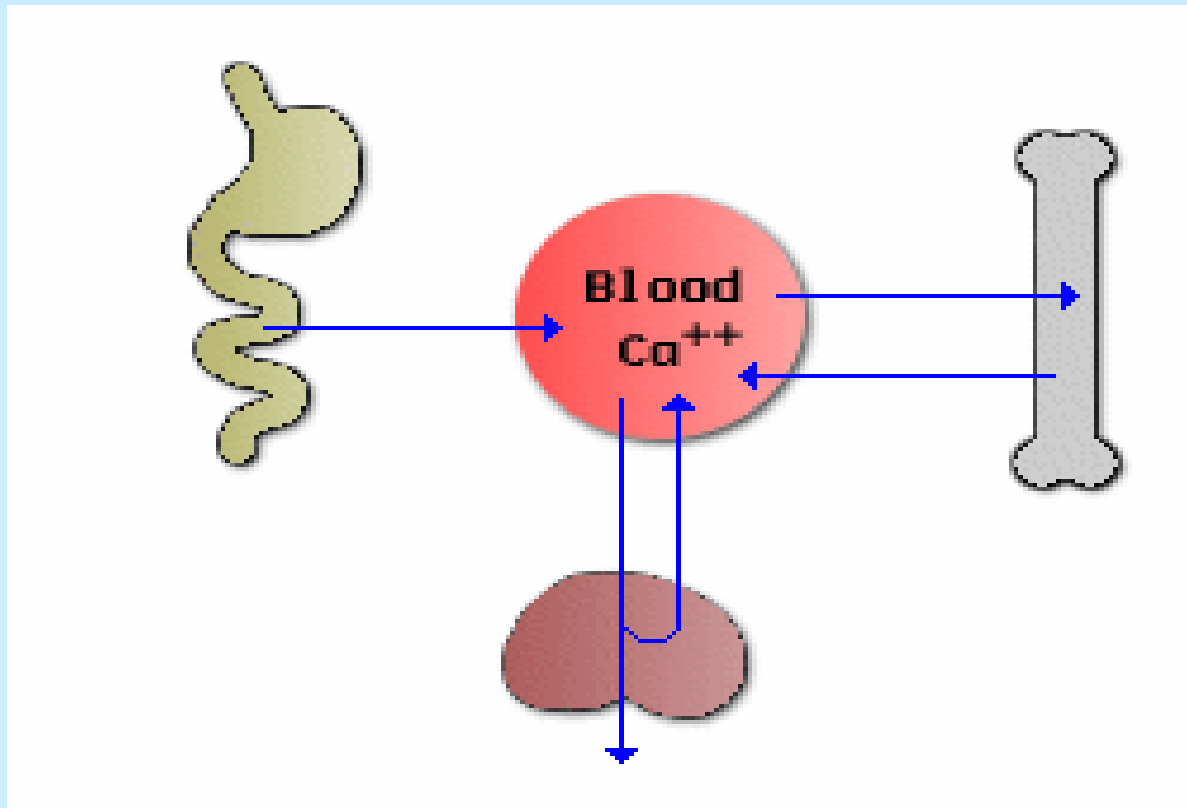

Homeostasis

1. is a dynamic balance
2. ... In spite of a multitude of stimuli
3. ... Maintained by (usually) negative (and rarely positive) feedback

Negative feedback

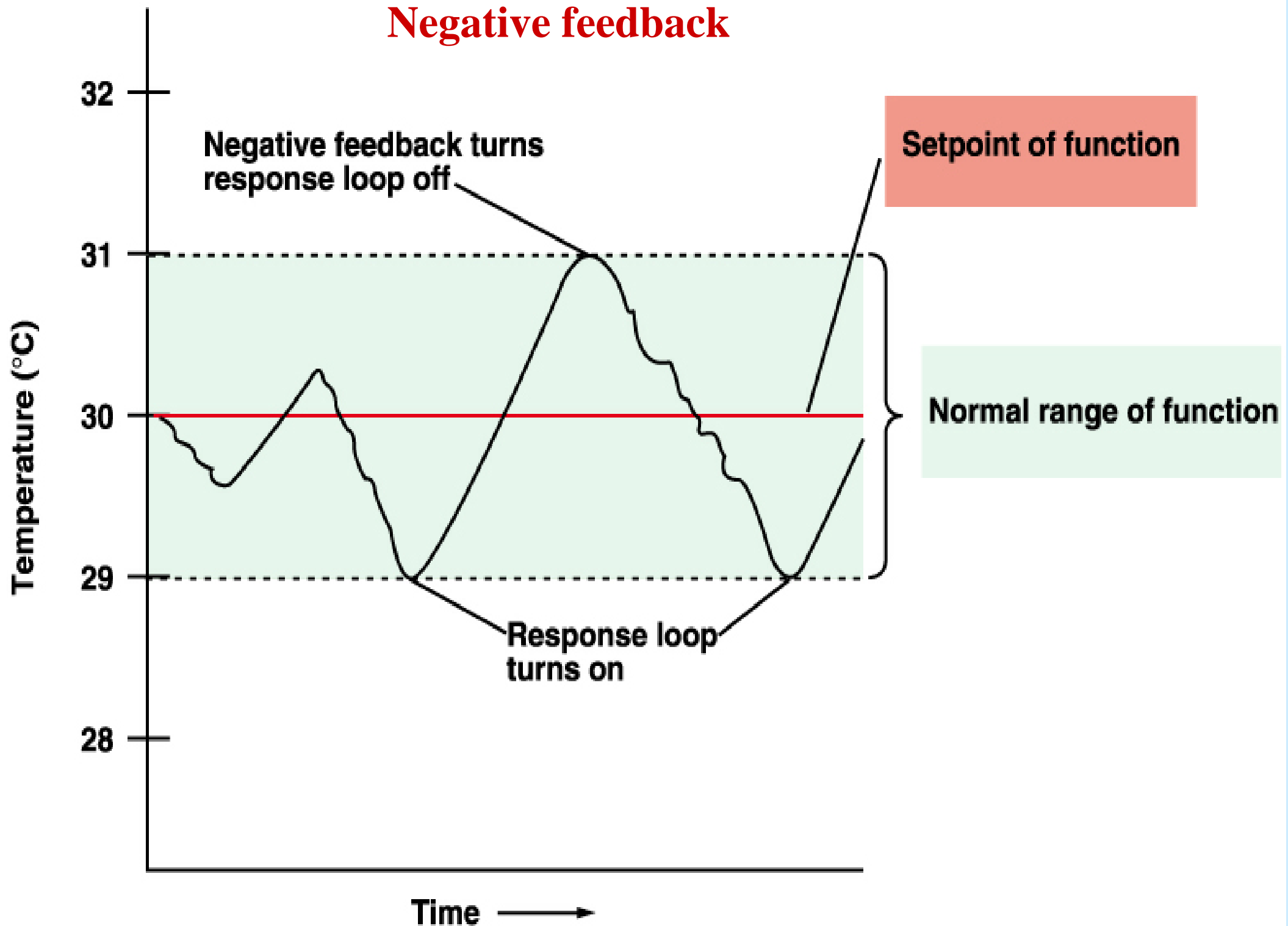

Negative feedback: Changes in blood pressure are being monitored by baroreceptors in the large arteries and through a control by the NS appropriate changes try to reverse these changes and maintain homeostasis

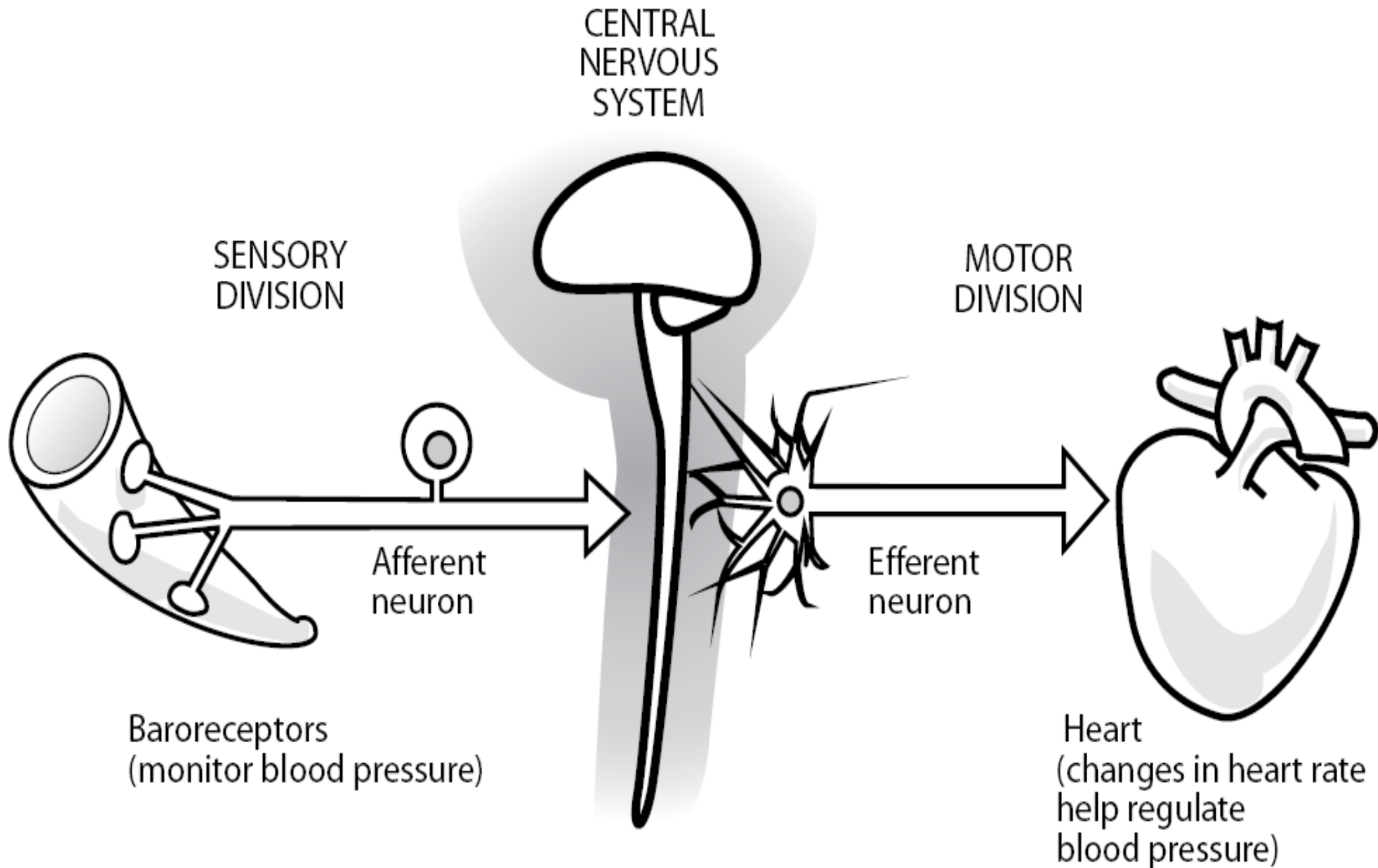

Negative feedback =
control mechanism in which a change in a monitored parameter evokes a response which counteracts that change

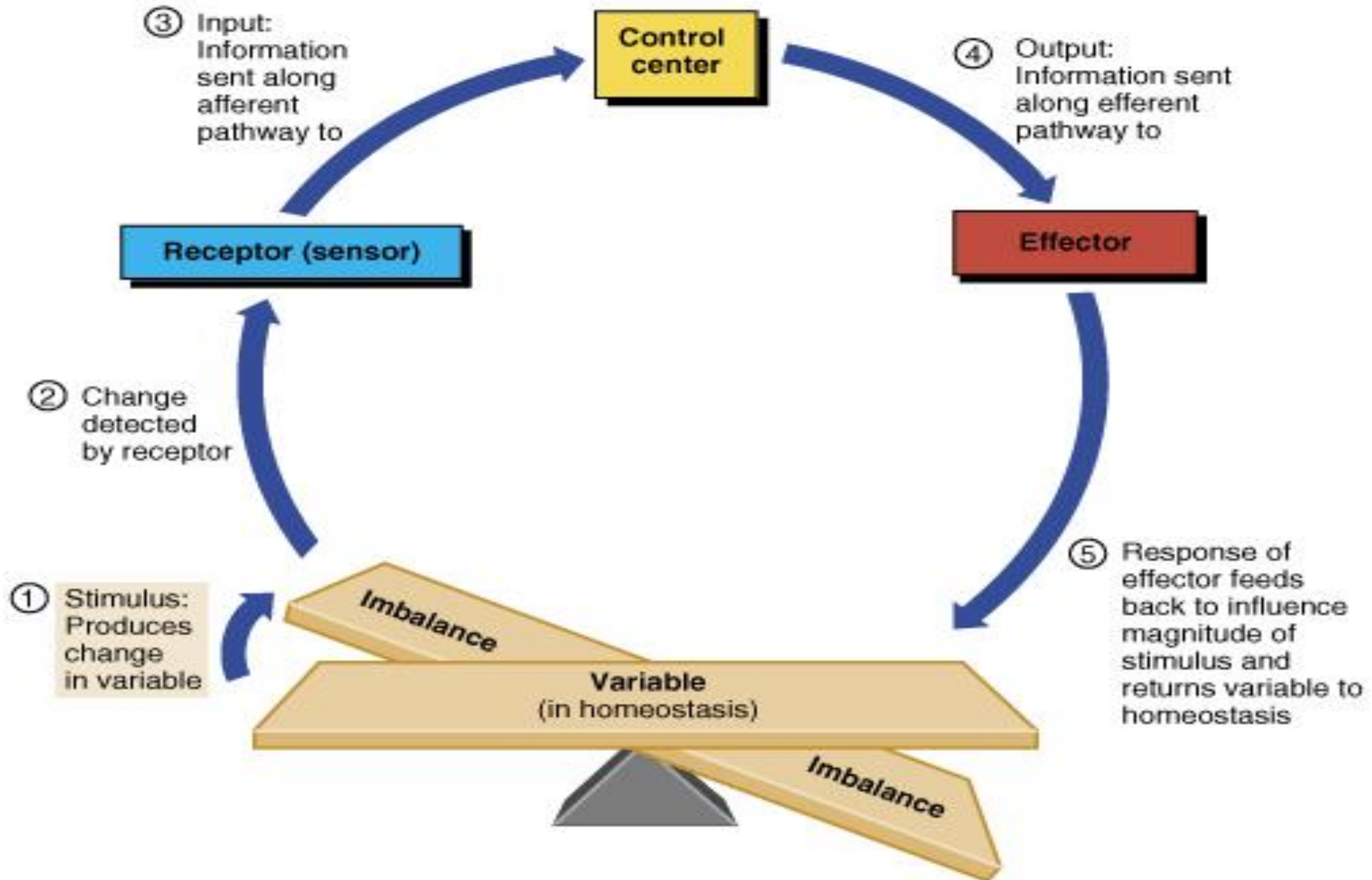

Negative feedback - error signal \Rightarrow *reduce* deviation from reference point

Positive feedback - error signal \Rightarrow *increase* deviation from reference point
(vicious circle)

Negative feedback

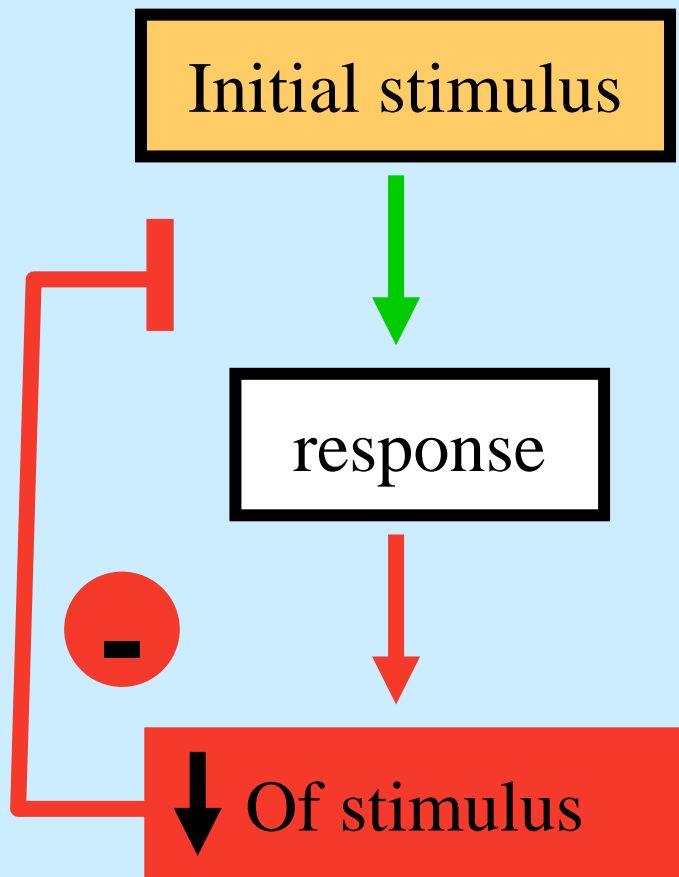

Positive feedback

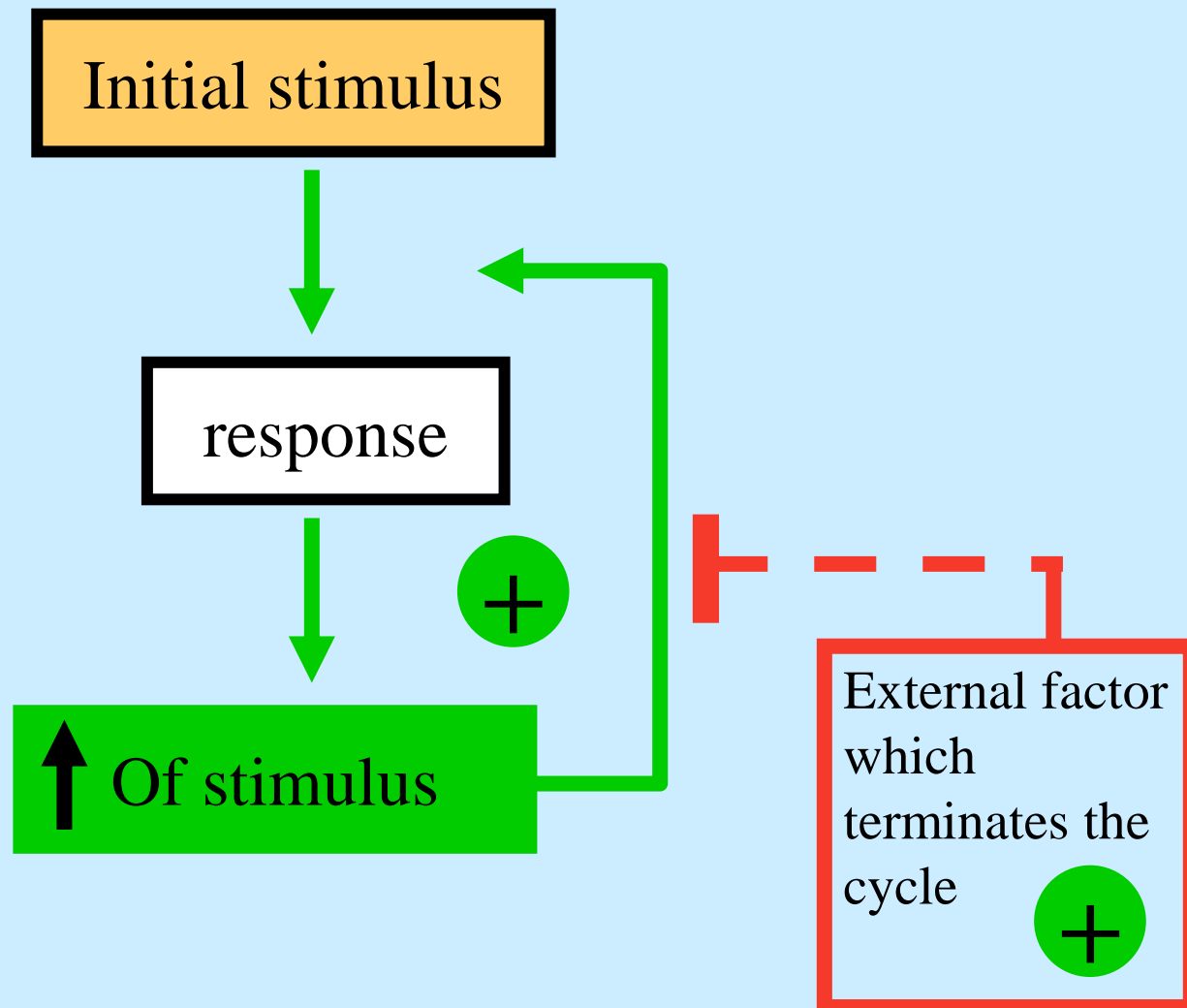

Positive feedback

Rarely used in homeostasis because they are catastrophic, unless they have a limit.

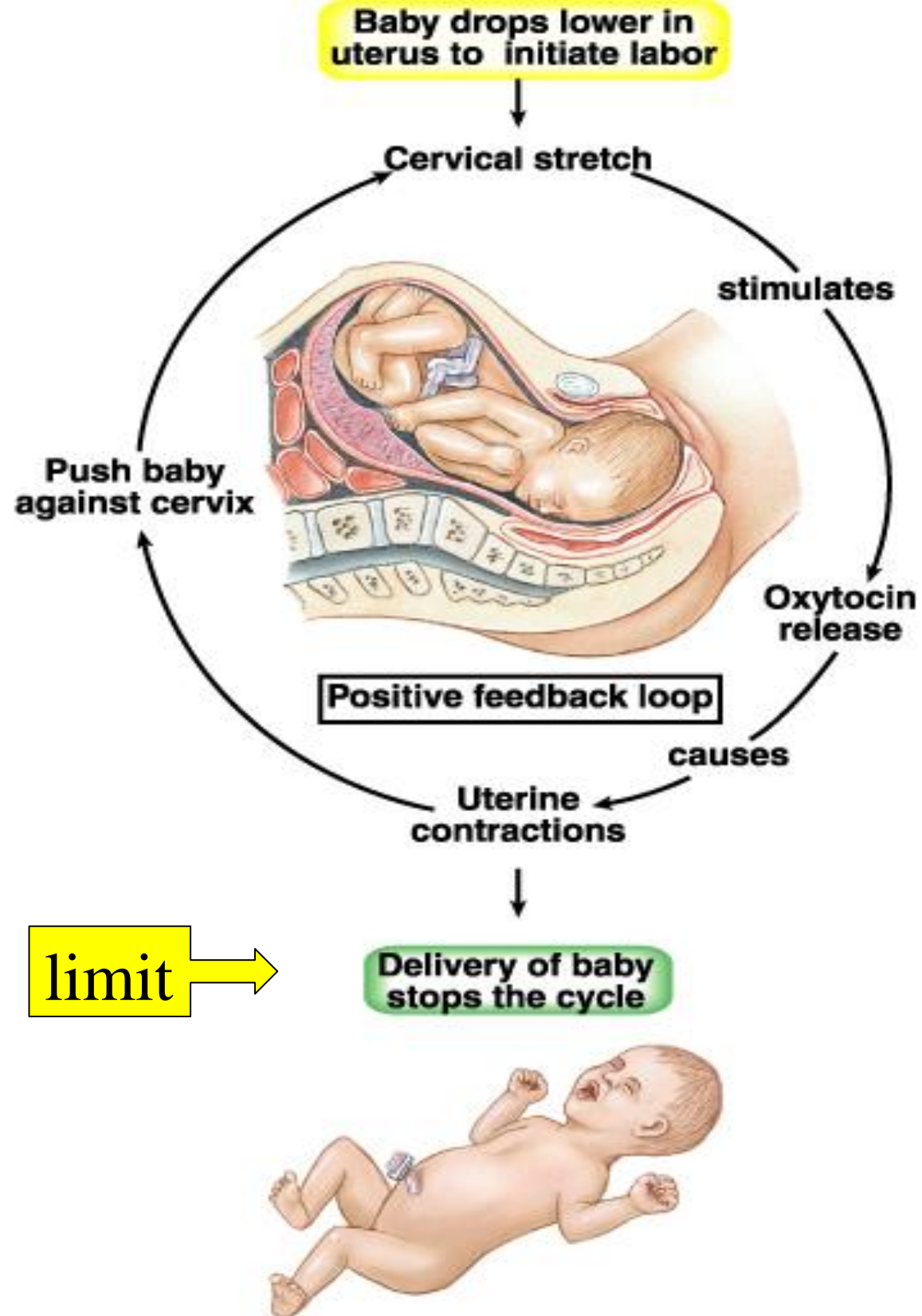

① Break or tear in blood vessel wall

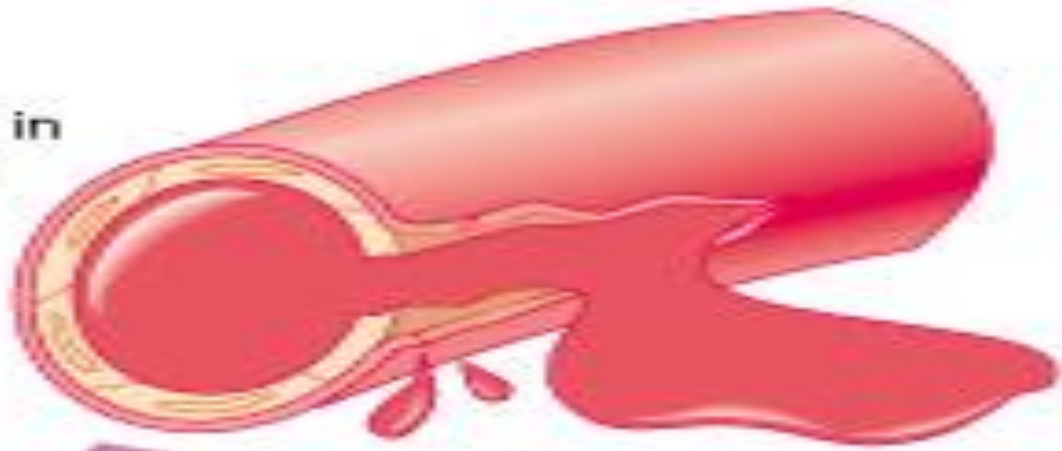

Positive feedback

② Clotting occurs as platelets adhere to site and release chemicals



③ Released chemicals attract more platelets

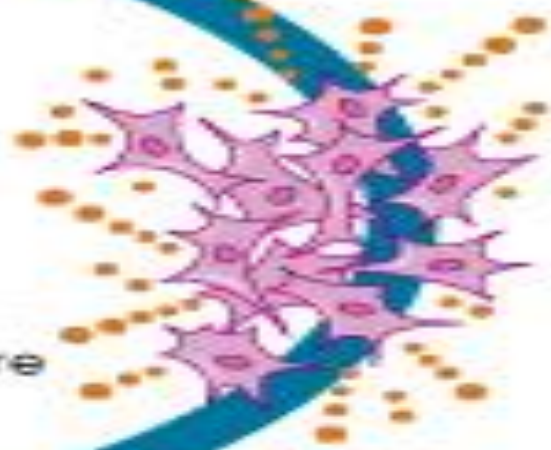

④ Clotting proceeds until break is sealed by newly formed clot

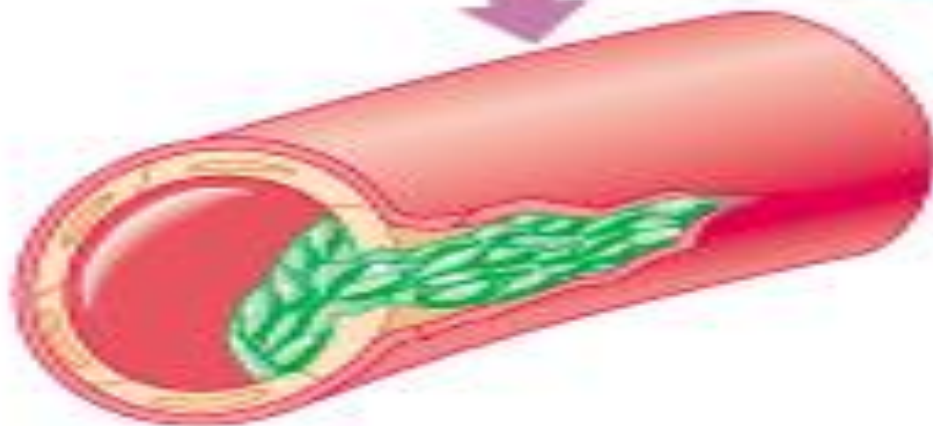

Disease ...

... is the failure to maintain homeostatic conditions, when challenged by

1. pathogens or parasites,
2. inherited disorders,
3. loss of normal regulatory control mechanisms
4. degenerative changes,
5. trauma,
6. toxins, environmental hazards,
7. nutritional factors.

Pathology – is the study of disease.

Pathophysiology – is the study of the functional changes leading to a disease..

Themes in Physiology

- Homeostasis
- Integration of body systems.
- Cell-to-cell communication and coordination.
- Movement of substances and information across cell membranes.
- Compartmentation of the body and cell.
- Energy flow.
- Mass balance and mass flow.

Control Pathways

Three components: stimulus or change in conditions, evaluation of the change and initiating a response, and the response.

Local control – paracrine or autocrine response.

Reflex control pathway – respond to changes that are more widespread or systemic in nature.

- .Nervous system
- .Endocrine system
- .Cytokines

Reflex Pathways

Response loop – input signal, integration of the signal, and output signal. **Integrating center** compares incoming (**afferent**) signal from sensor (**receptor**) to **setpoint** and alters outgoing (**efferent**) signal to **effector** accordingly. Receptors have **threshold** which must be exceeded to set reflex in motion.

Feedback loop – modifies response loop.

Homeostatic if **negative**. **Positive feedback loops** are not homeostatic.

Feed forward Control

Allows body to predict that a change is about to occur.

Response loop starts in anticipation of change, e.g. seeing, smelling, or thinking about food.

Circadian rhythms – evolutionary response to 24-hr day and to seasons.

Control Systems

Specificity – direct contact between nervous system and target cells. Endocrine more general so multiple tissues can respond simultaneously.

Nature of Signal – electrical and chemical for nervous system. Chemical for endocrine.

Speed – Fast for nervous reflexes (120 m/s). Slow for endocrine, min to hr.

Duration of Action – Shorter for nervous control than for endocrine. Neurotransmitters removed rapidly. Depend on multiple repeating signals.

Coding for Stimulus Intensity – depends of frequency of signal for nervous control. Depends on amount of hormone for endocrine control.

1.1. Defining Physiology

1.2. Homeostasis

1.3. Inter-cellular Communication

1.4. Methods

1.5. Energy

Gap junctions

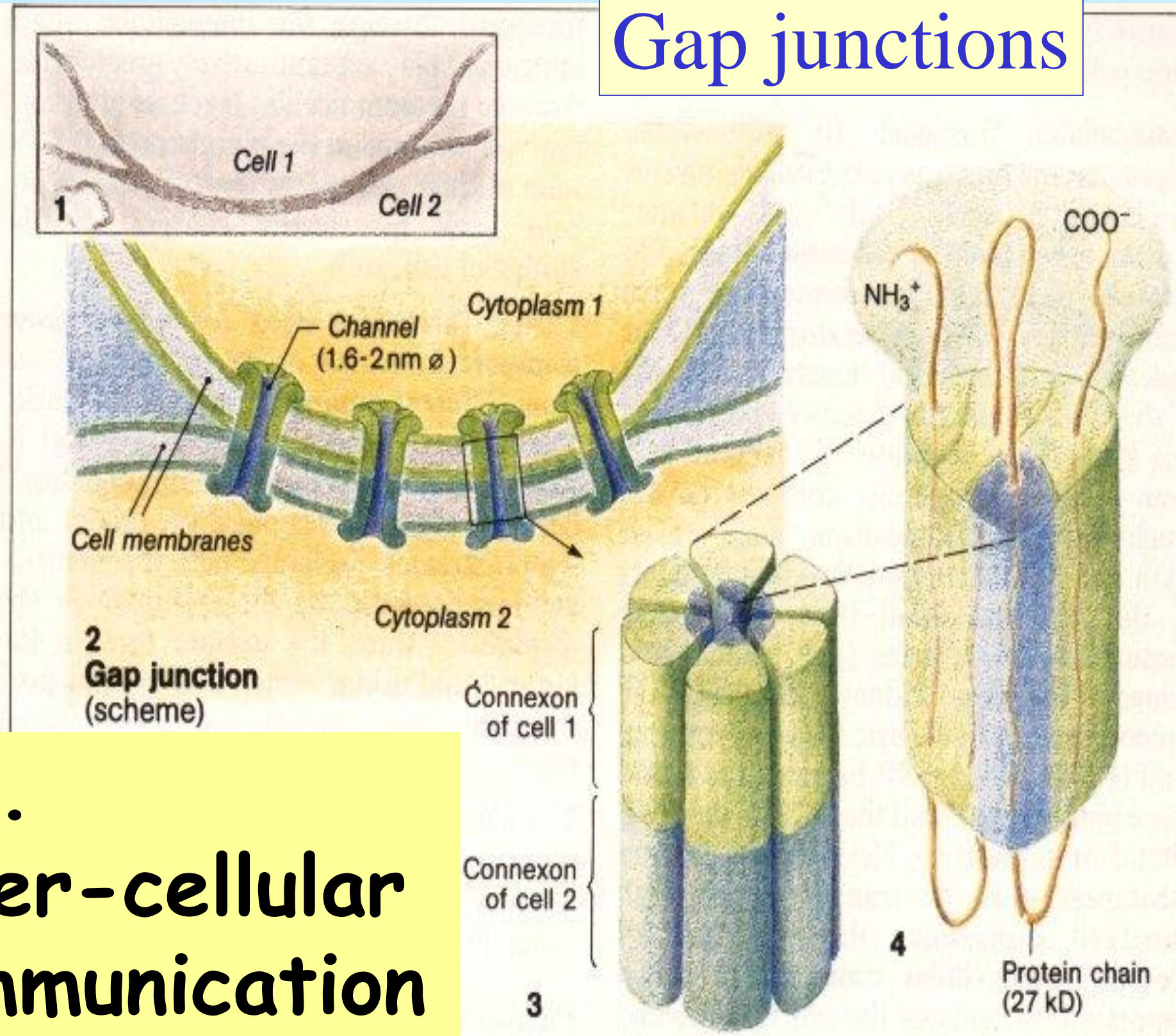

1.3. Inter-cellular Communication

Gated Channels

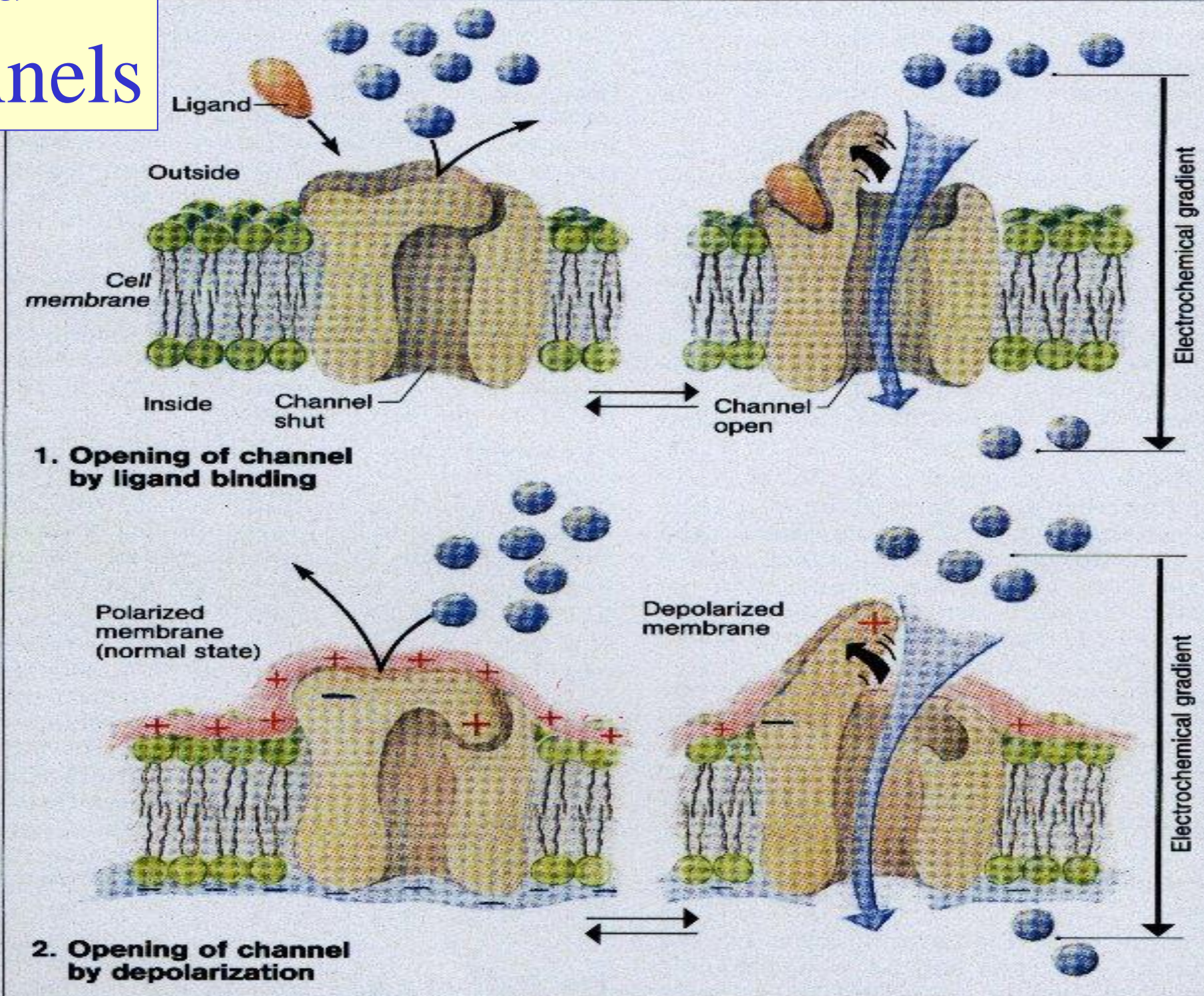

Gap junctions

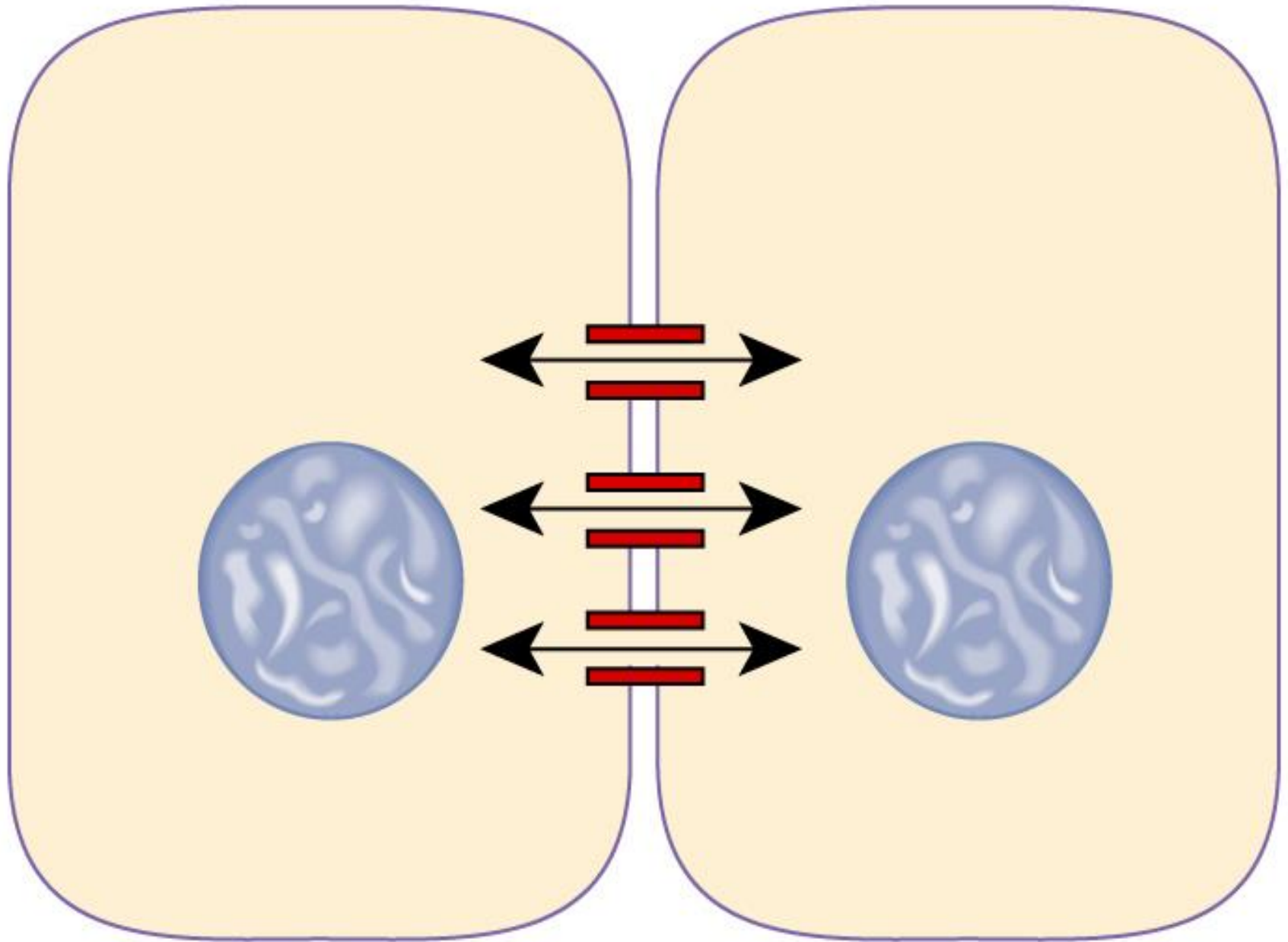

Autocrine and paracrine signals

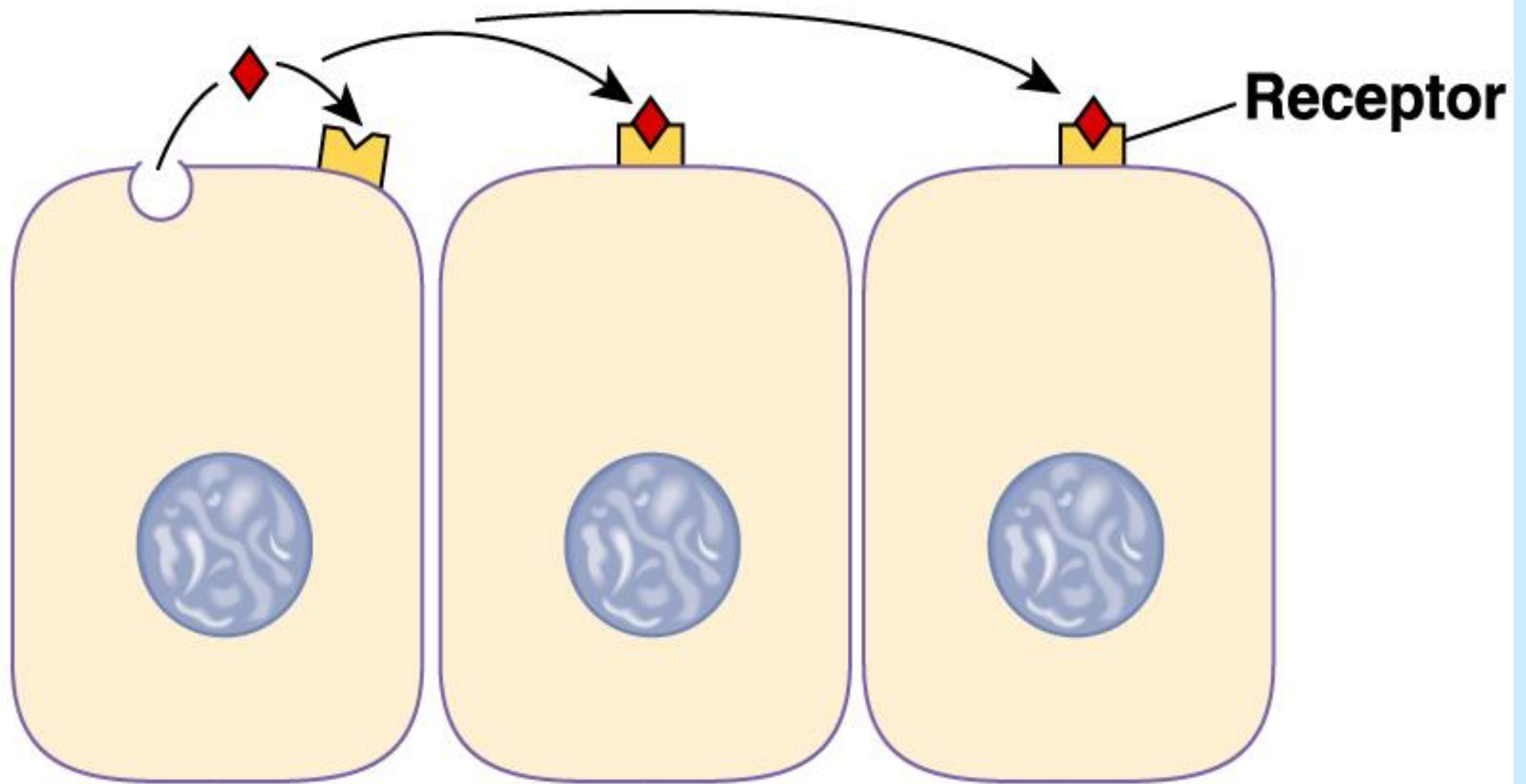

Hormone

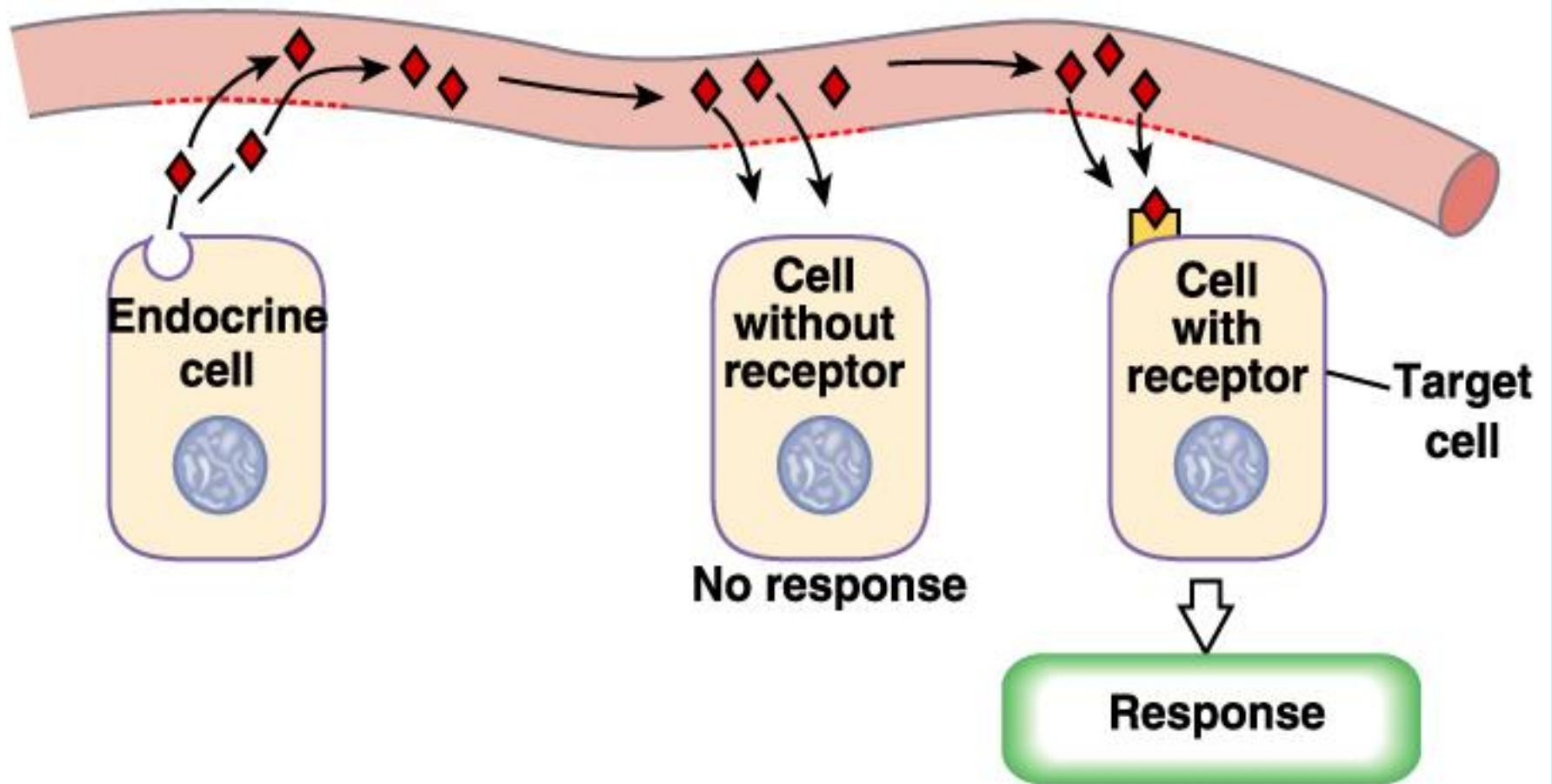

Neurotransmitter

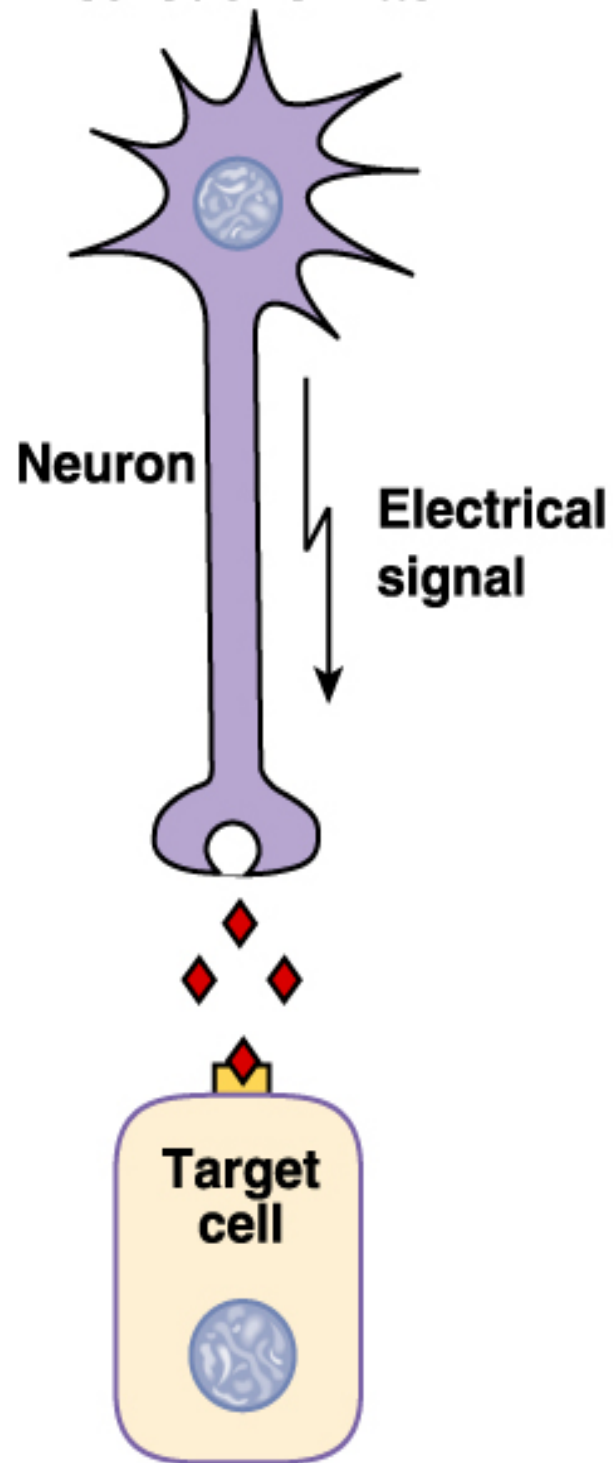

Neurohormone

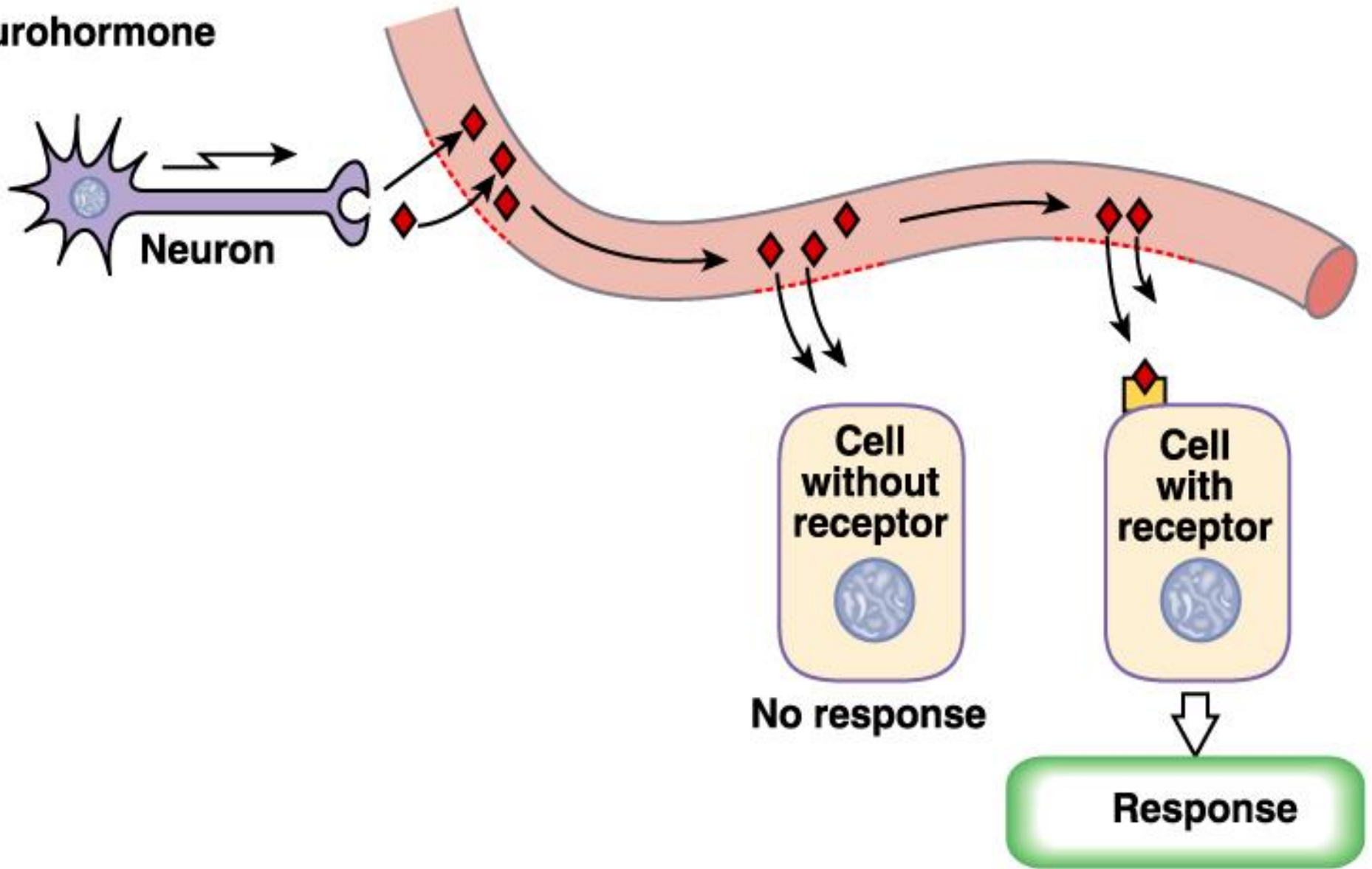

Cell-to-Cell communication

Gap junctions

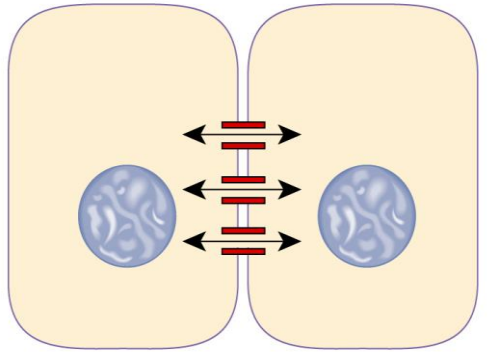

direct

local

Autocrine and paracrine signals

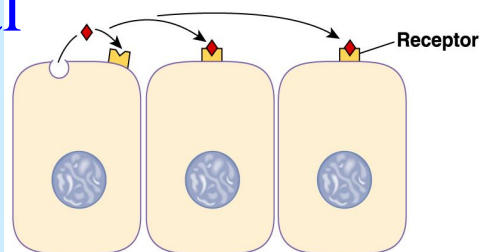

Hormone

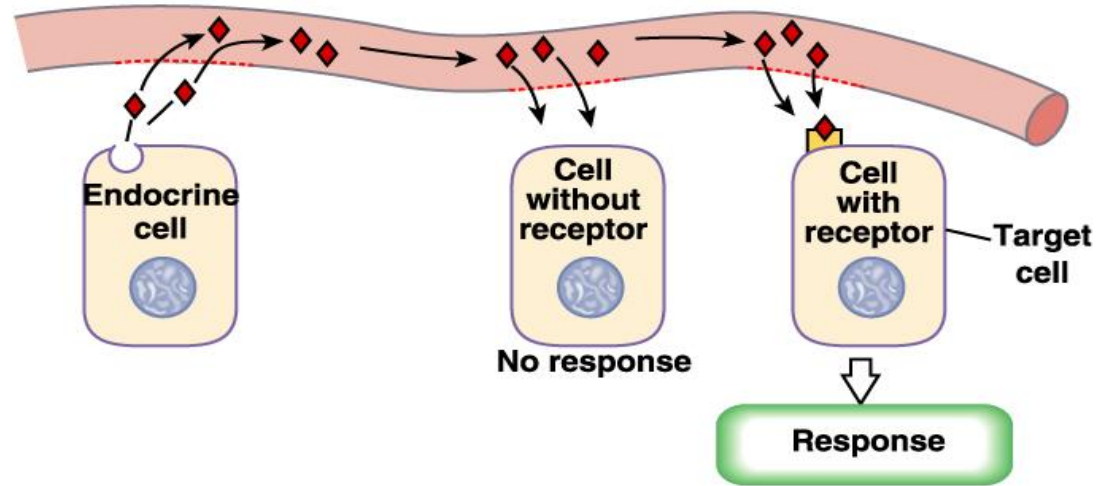

Neurohormone

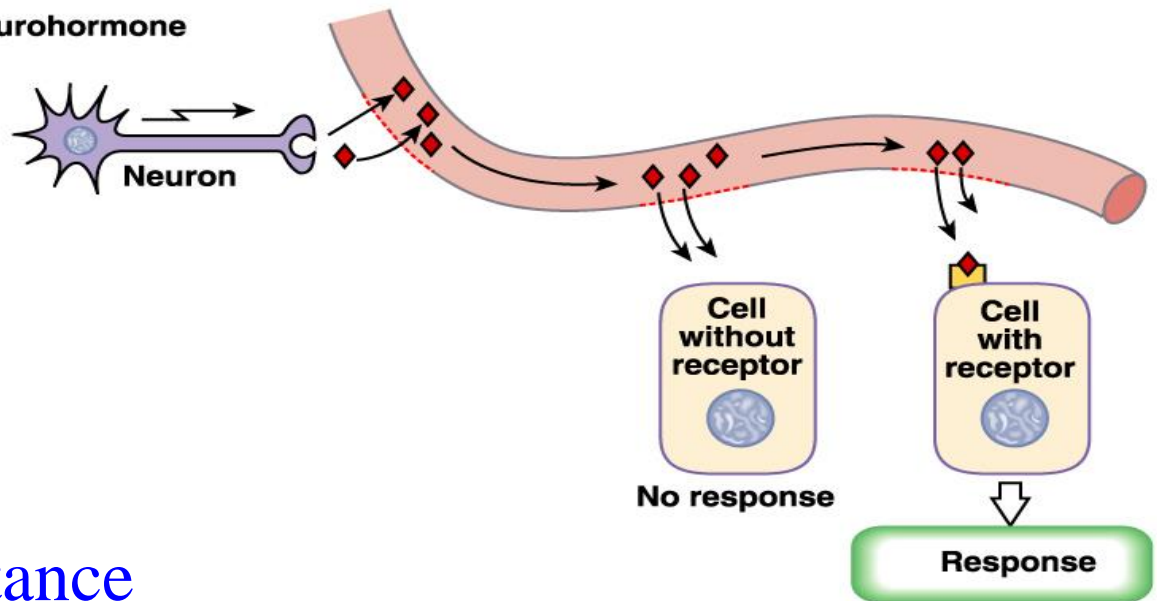

From distance

Neurotransmitter

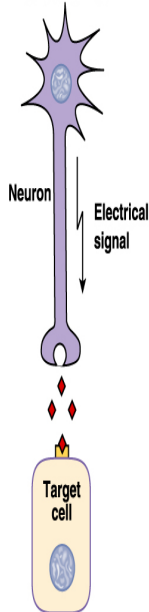

There are two basic types of physiological signals:

- **electrical**
- **chemical**

There are three ways of inter-cellular communication:

1. **Direct** transfer through gap junctions
2. **Local** chemical communication (paracrine messages from neuromodulators, cytokines, eicosanoids etc.)
3. Communication **from distance**

Target cell receptors

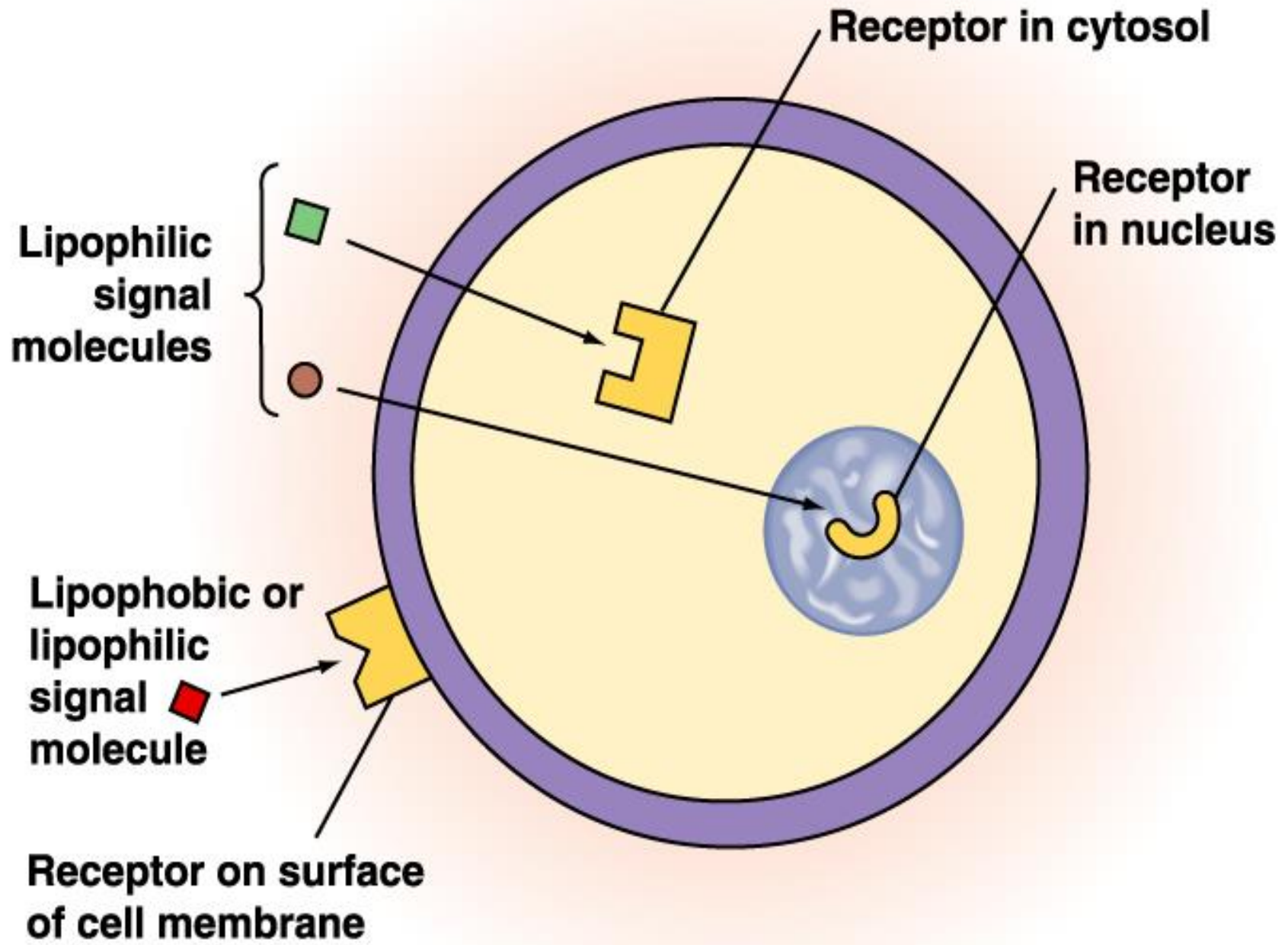

Four classes of membrane receptors

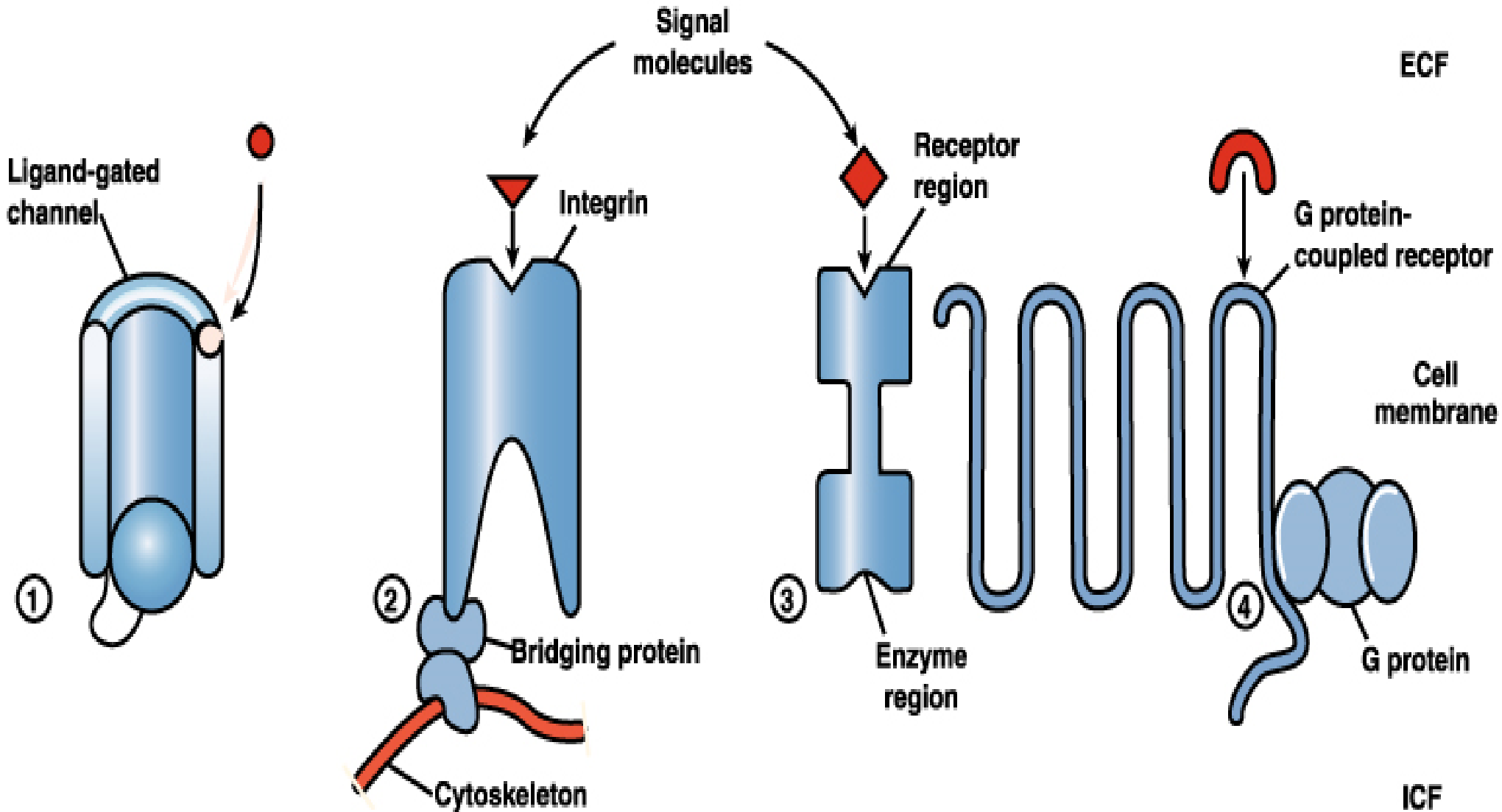

Through channel opening...

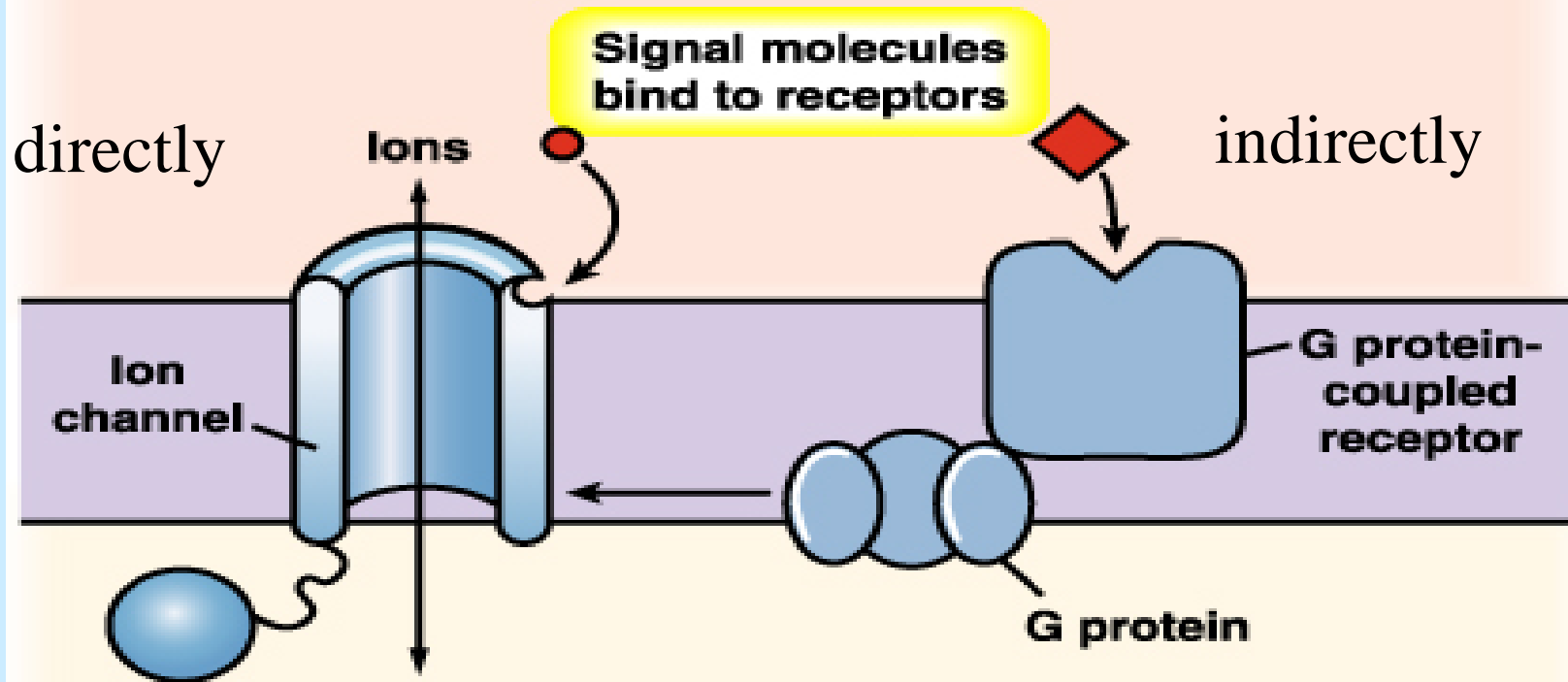

...movement of ions create electrical signals

Change in membrane permeability to Na^+ , K^+ , Cl^-

Creates electrical signal

Voltage-sensitive protein

Cellular response

External signal



Receptor
↓
Transducer
↓
Amplifier



Response



Radio waves



Radio

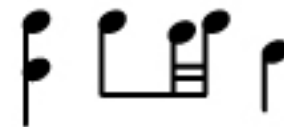
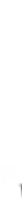

Sound waves

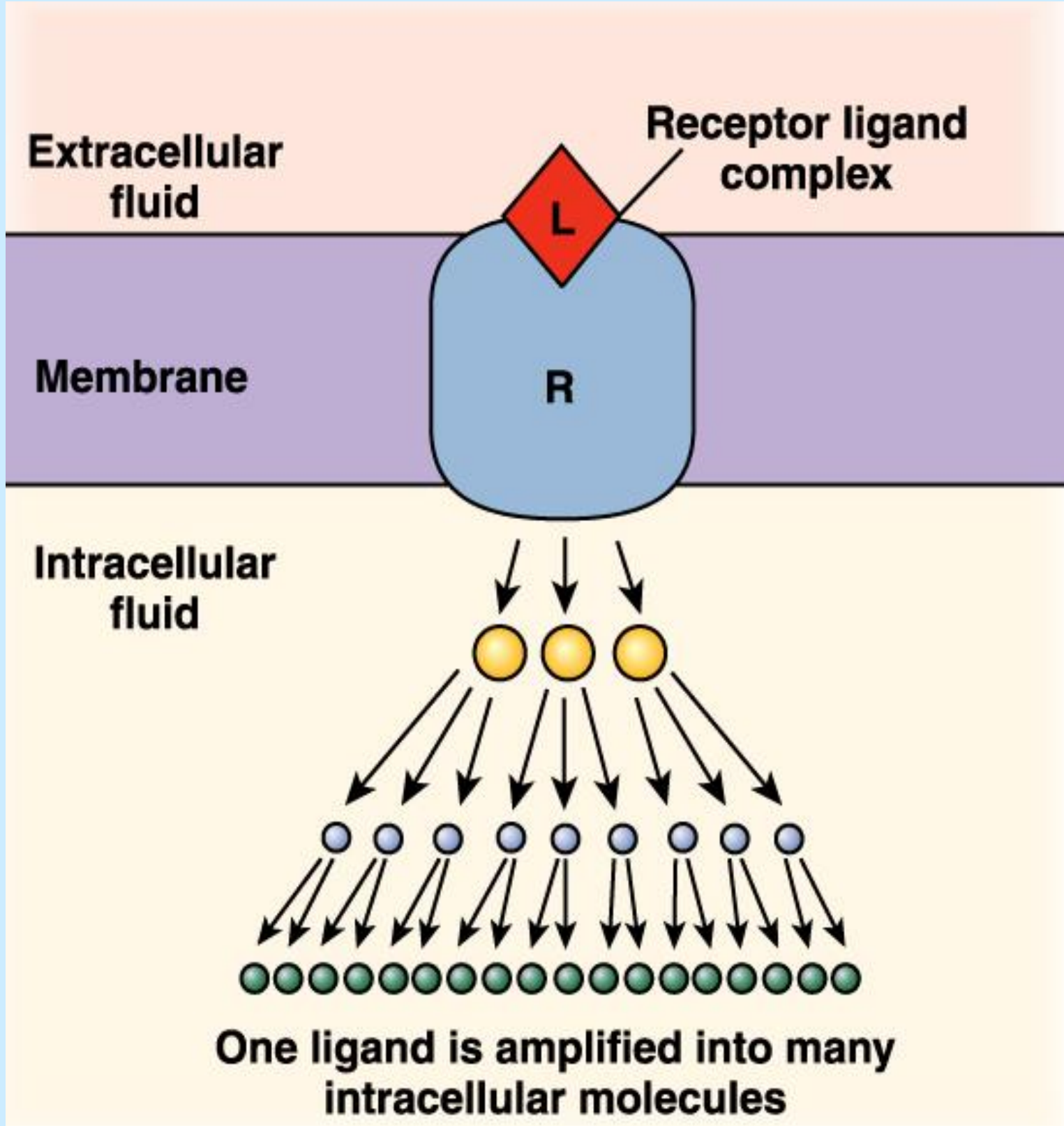

Extracellular fluid

Receptor ligand complex

L

Membrane

R

Intracellular fluid

One ligand is amplified into many intracellular molecules

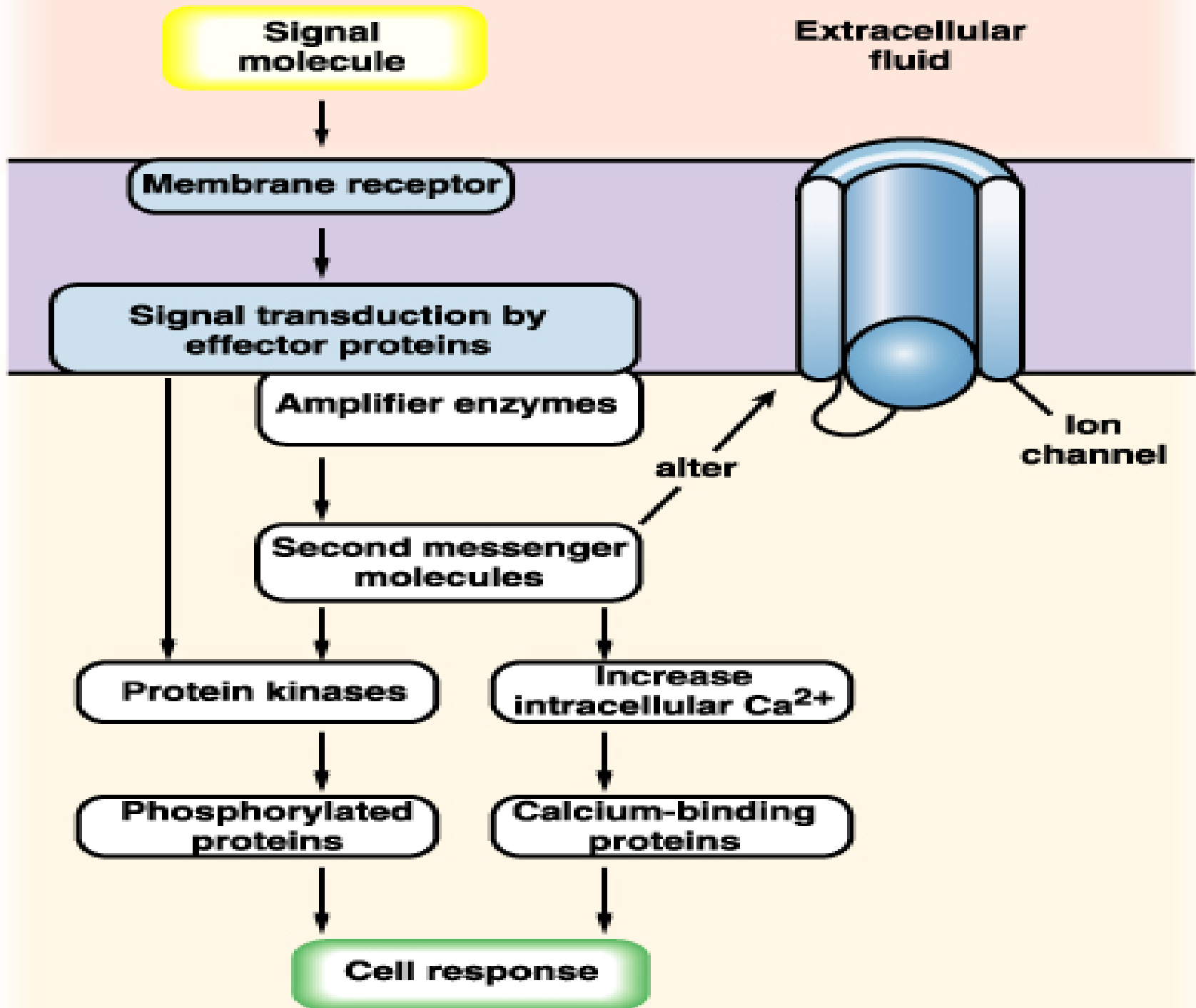

Initial stimulus



Inactive A

Active A



Inactive B

Active B



Inactive C

Active C



Substrate

Product

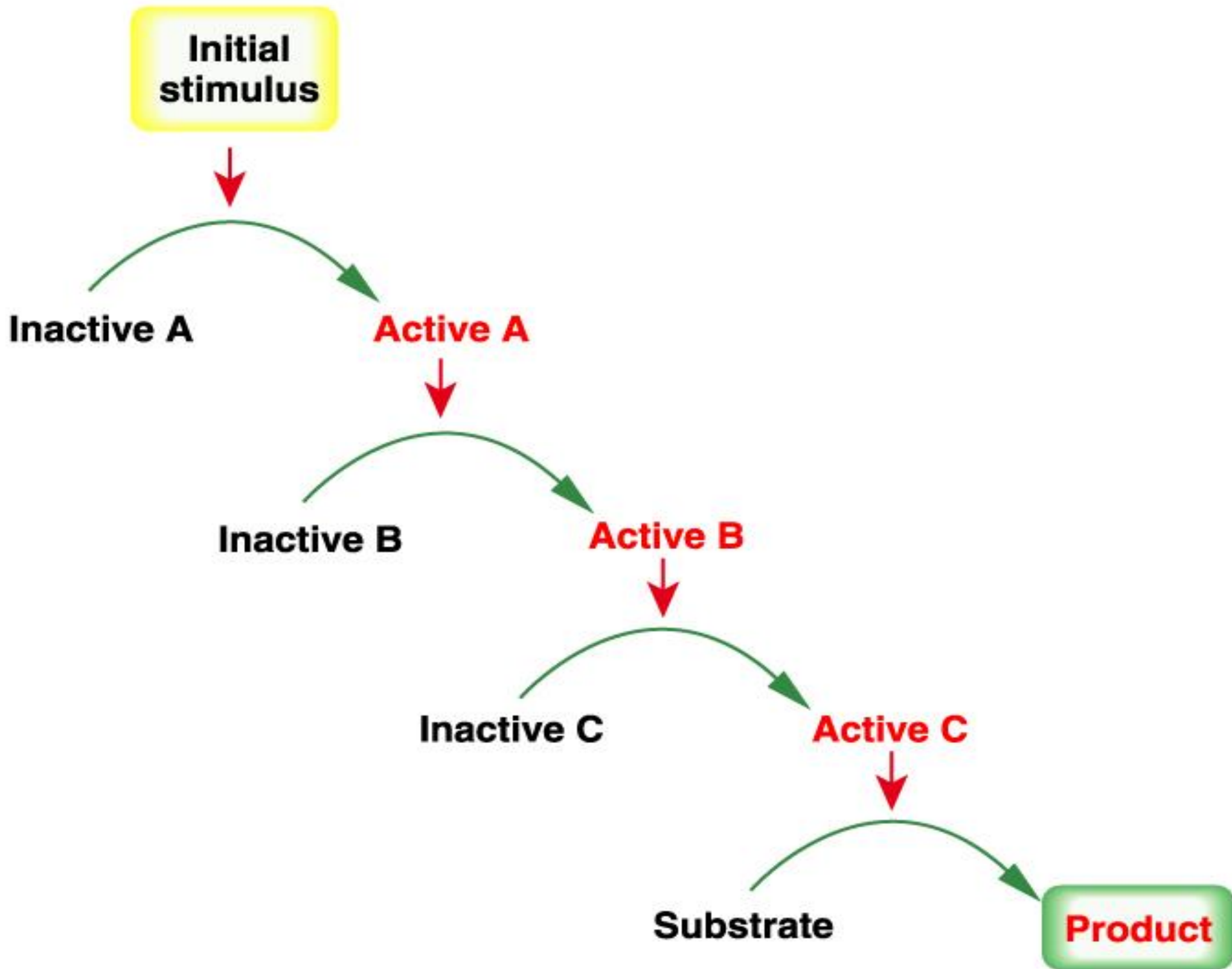

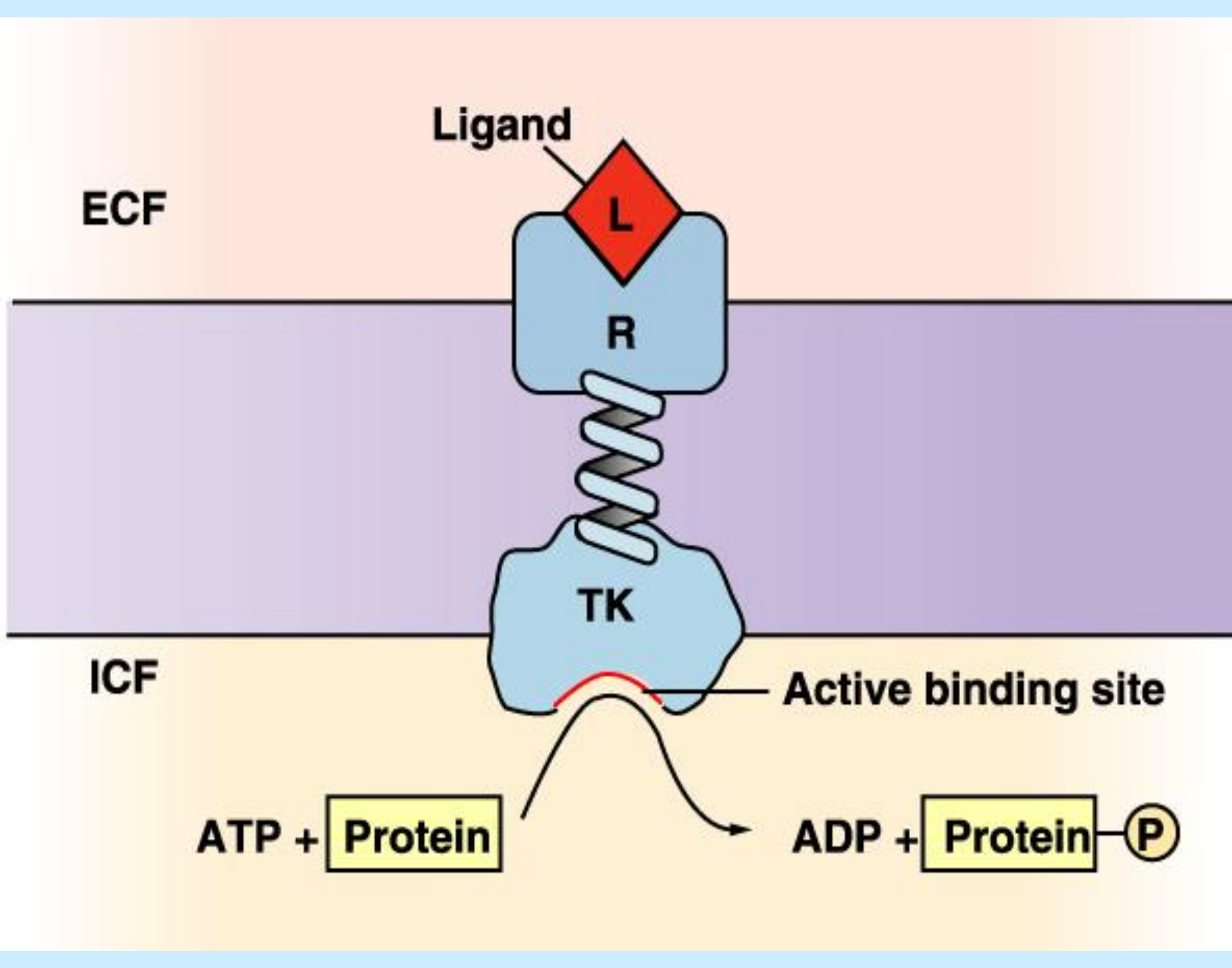

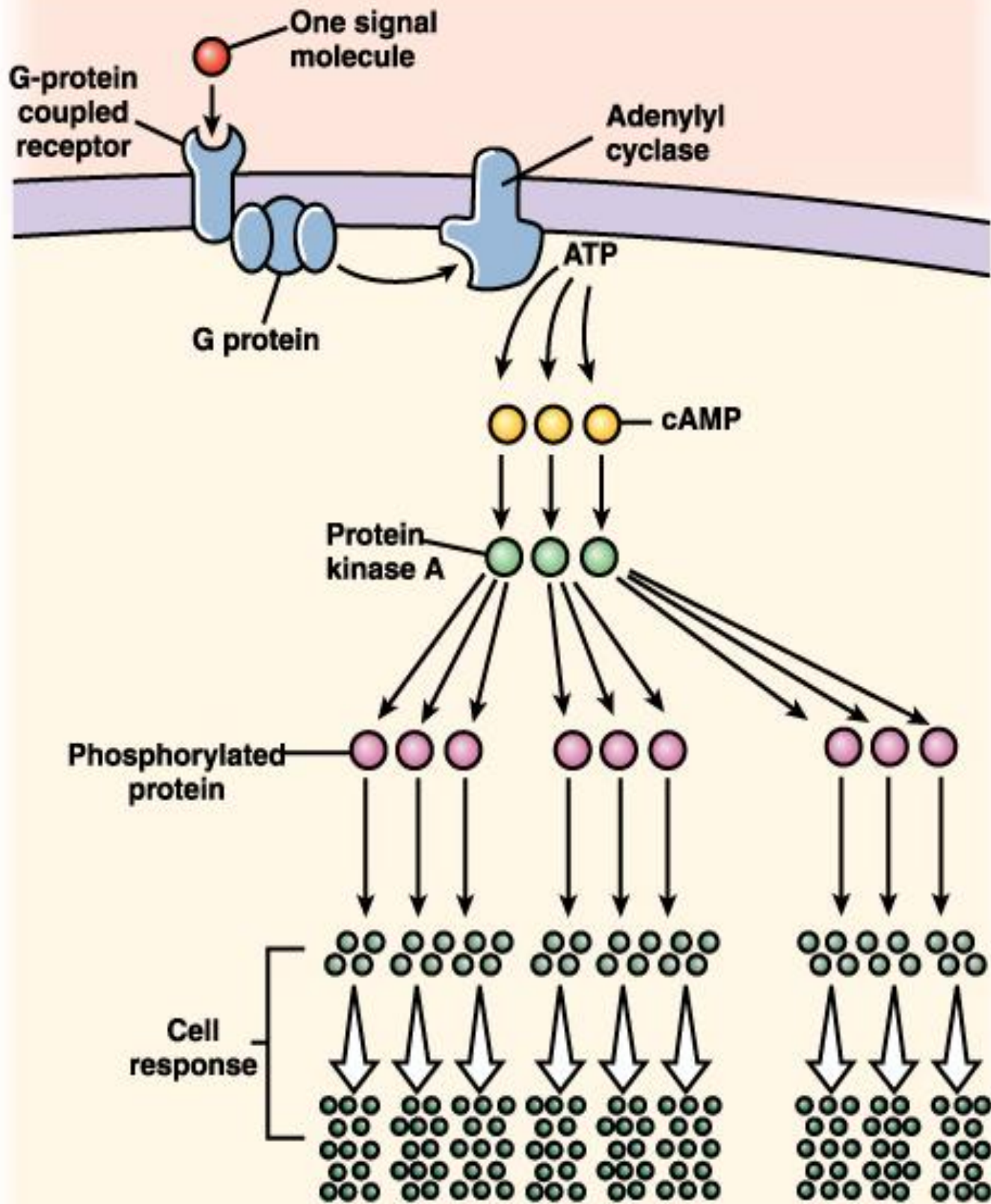

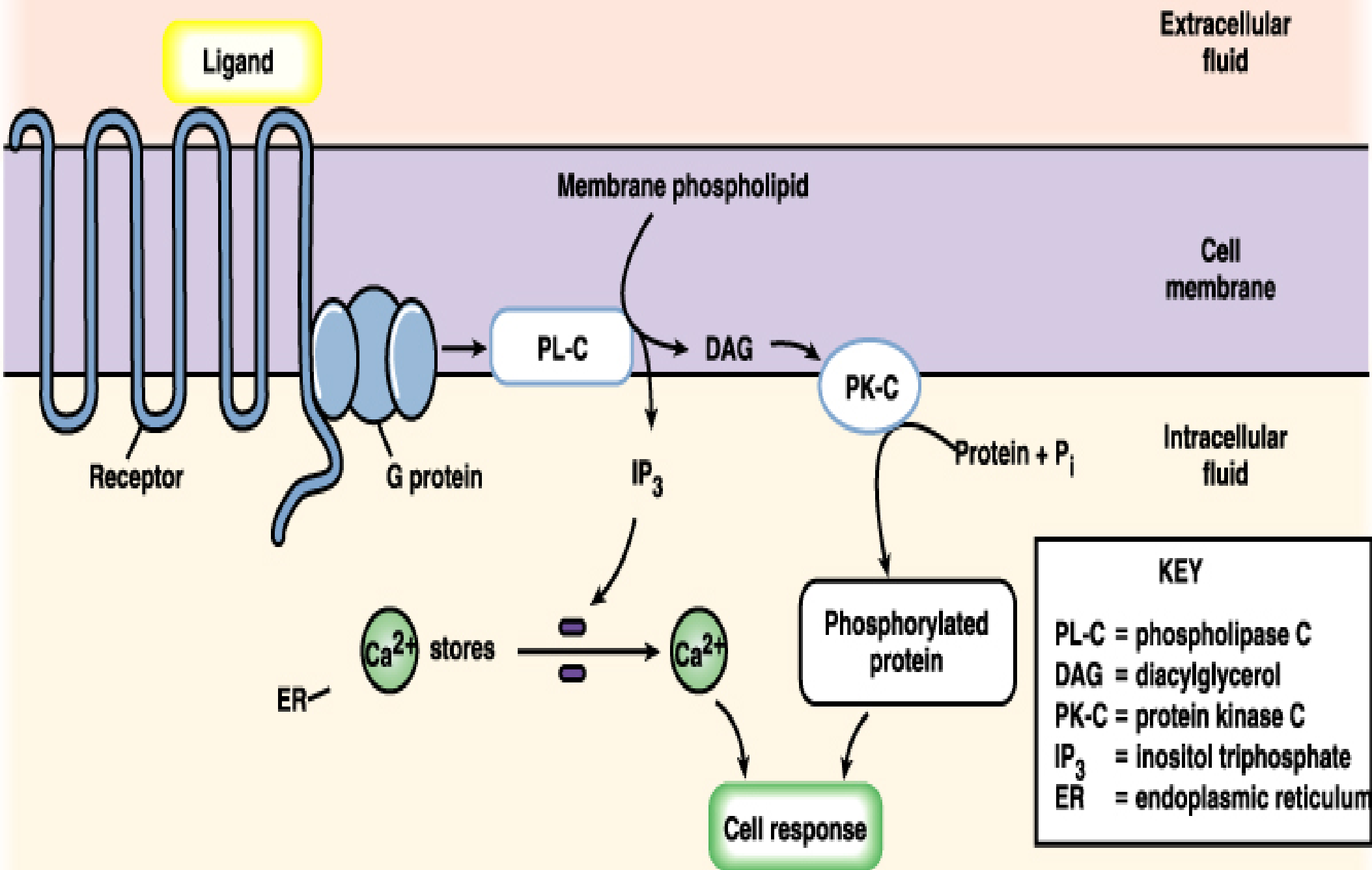

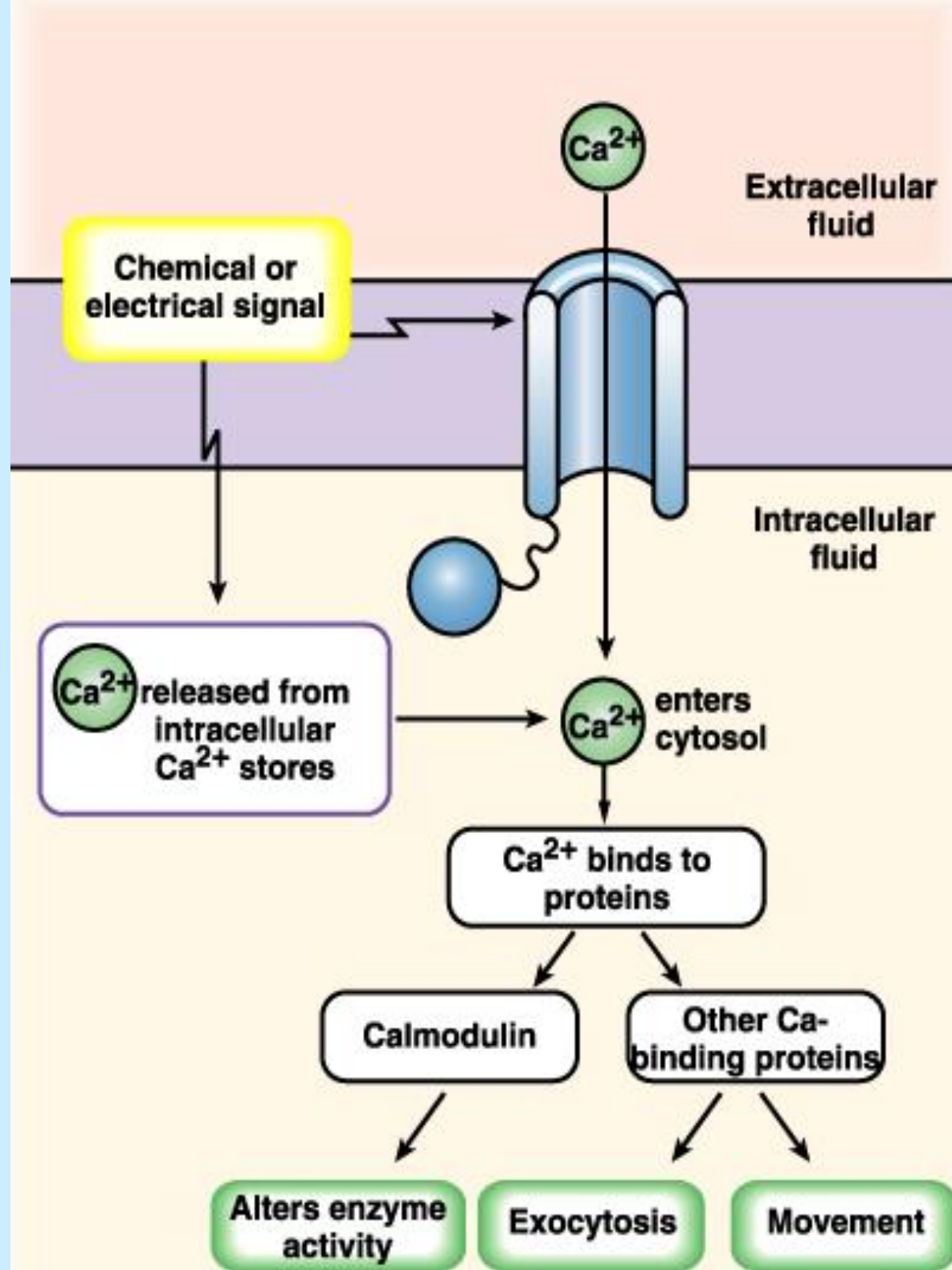

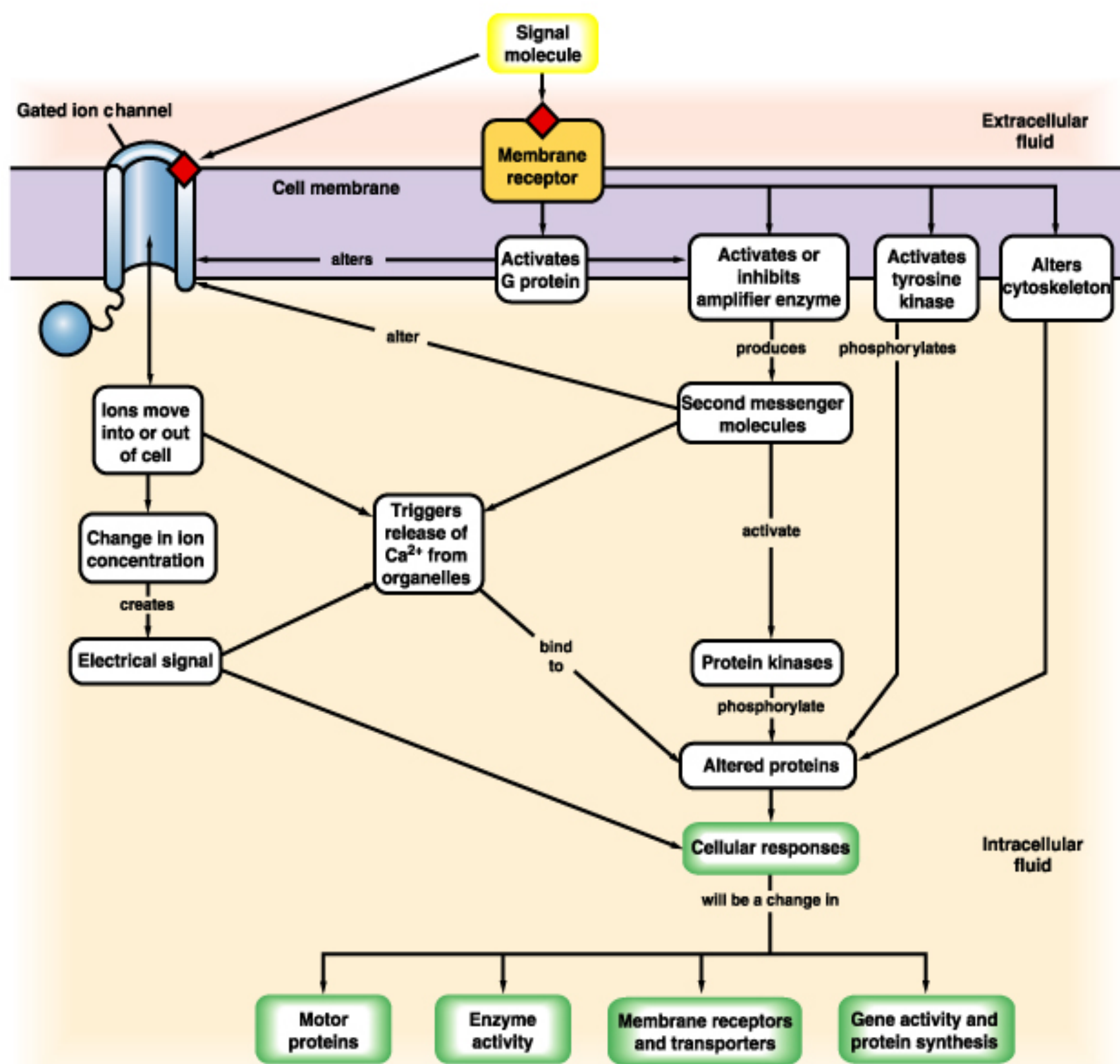

**Primary
ligand**

Agonist

Antagonist

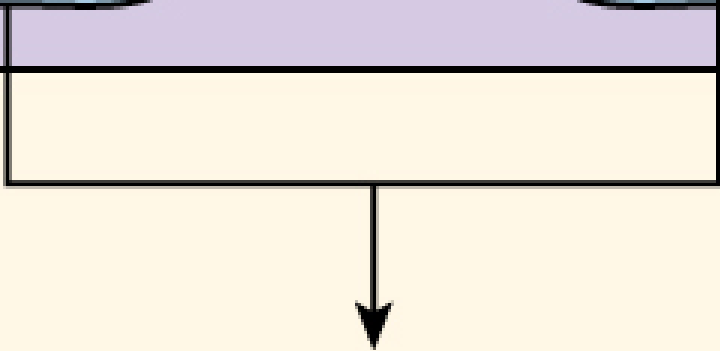
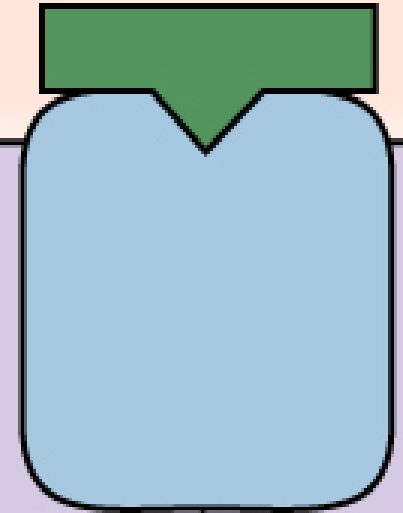
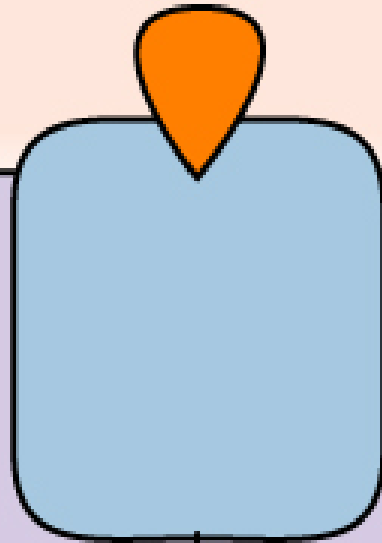
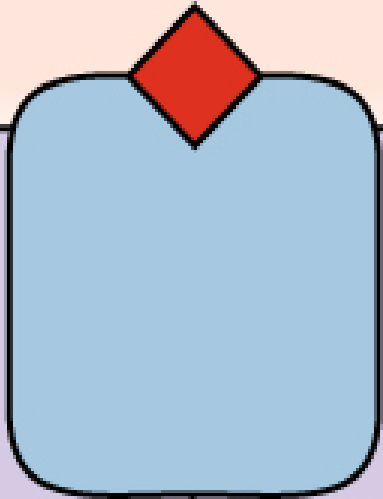
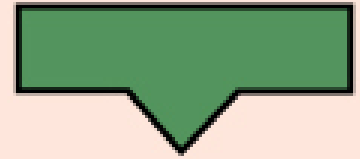

Response



**No
response**

An agonist may activate two types of receptors with two different actions

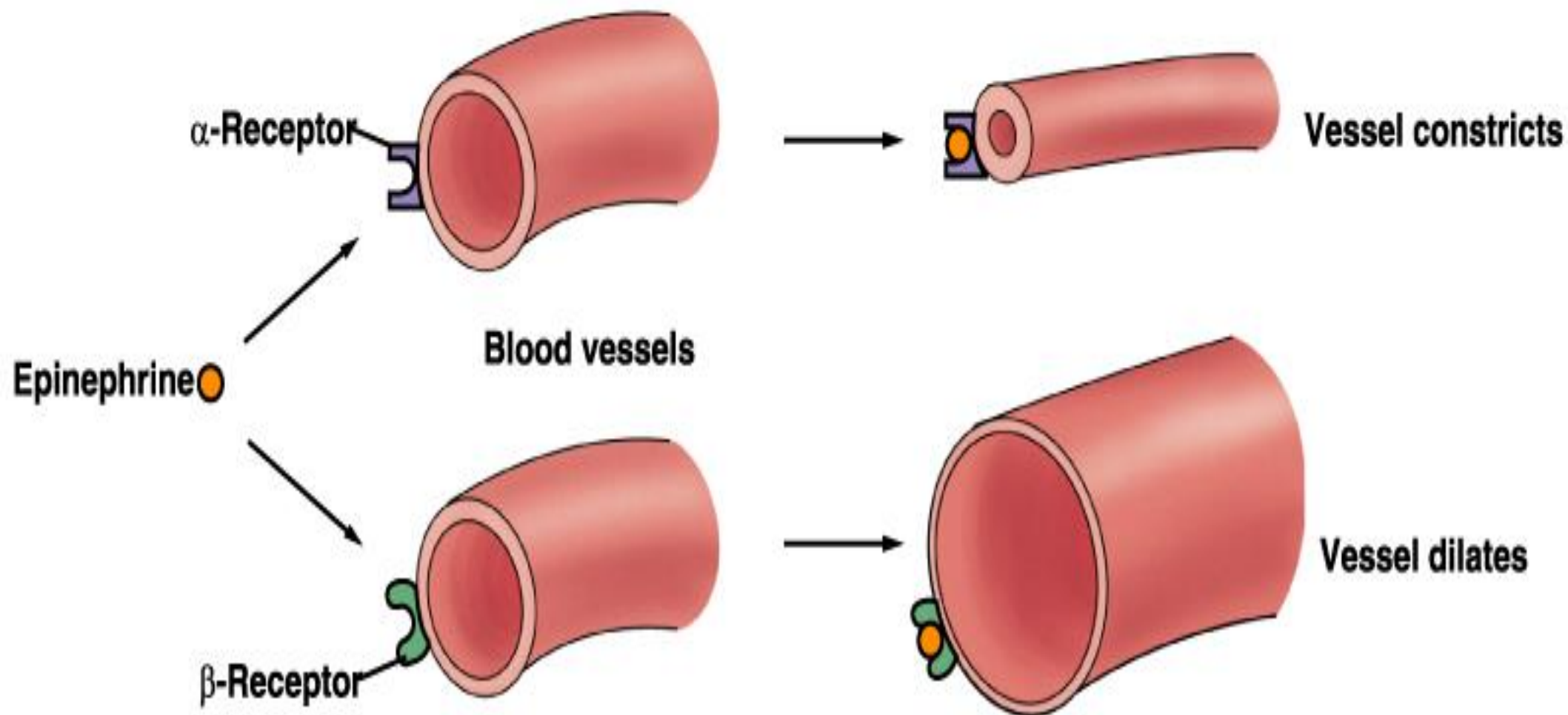

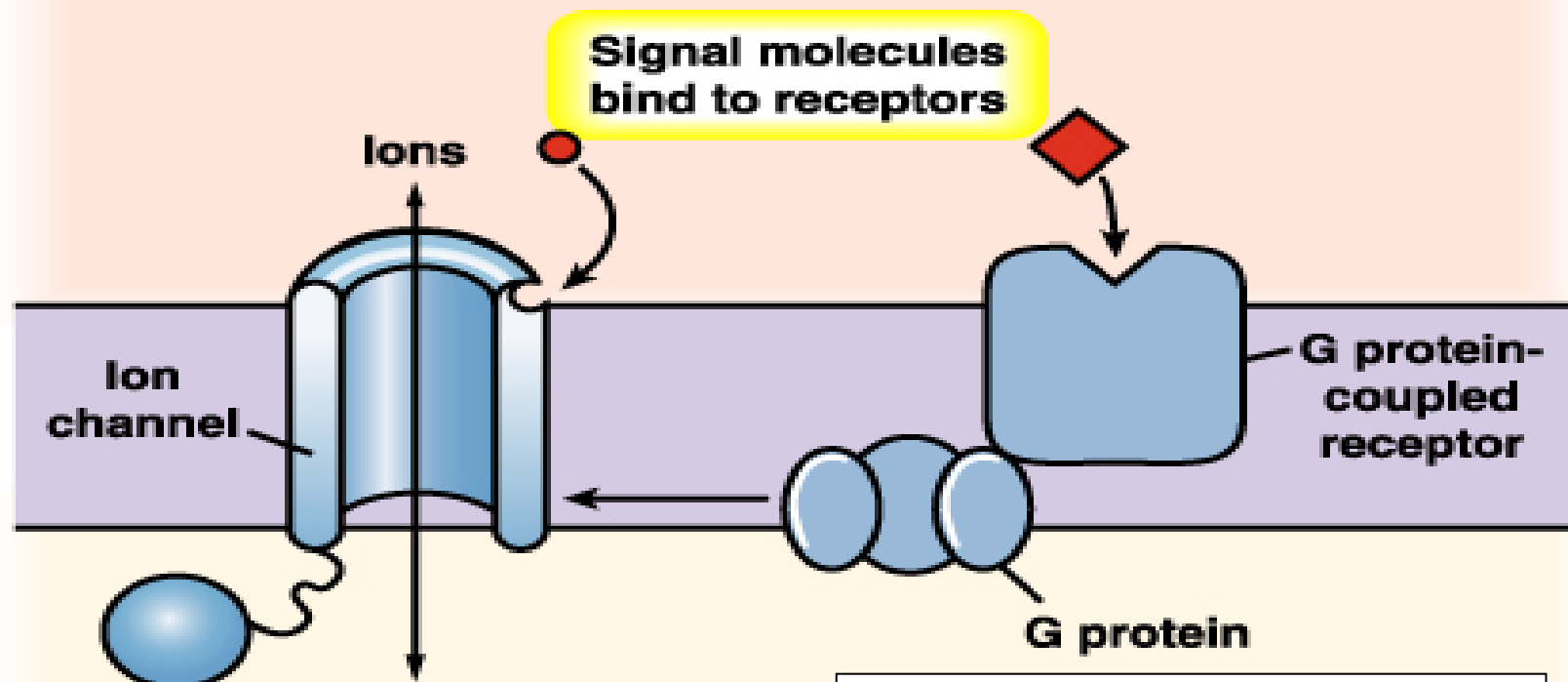

Change in membrane permeability to Na^+ , K^+ , Cl^-

Creates electrical signal

Voltage-sensitive protein

Cellular response

Movement of ions (Na^+ , K^+ , Ca^{++}) directly through channels or after activation of receptors produces electric signals, which instigate predetermined functional changes

1.4. Methods

Scientific Methods in Physiology

- What are the steps?
 - Observation
 - Hypothesis
 - Experimentation
 - Replication of results
 - Theory

Method (← μετά + οδός)

= follow someone on the road,

= examining a subject with some principles and rules of procedure

= the scientific way of research = the proper and logical way of achieving a goal

e.g. EEG, MEG, ECG

A method includes various

Techniques (← τέχνη ← τίκτω)

= a particular set of processes with which we face a specific problem in the framework of a general methodology and under specific circumstances

e.g. epidermal, epicortical, intracranial, extra- or intracellular recording of brain generated electrical potentials – evoked potentials, 3D visualization of EEG current sources in the framework of EEG METHOD

Experimentation

Independent variable – controlled by experimenter.

Dependent variable – responds to independent variable, i.e. gives experimental results.

Control group – same as experimental group except that manipulated variable is not manipulated. Purpose?

Experimental Design

Crossover study – each subject acts as both experimental and control group.

Blind study – subjects are not informed.

Double-blind study – subjects and experimenter are not informed.

Double-blind crossover study – same group for experiment and control, but double-blind.

Placebo effect – changes that occur because subjects are participating in the experiment.

Ethical Issues. i.e. when humans are used as experimental subjects

The standard features of a graph include units and labels on the axes, a key, and a figure legend.

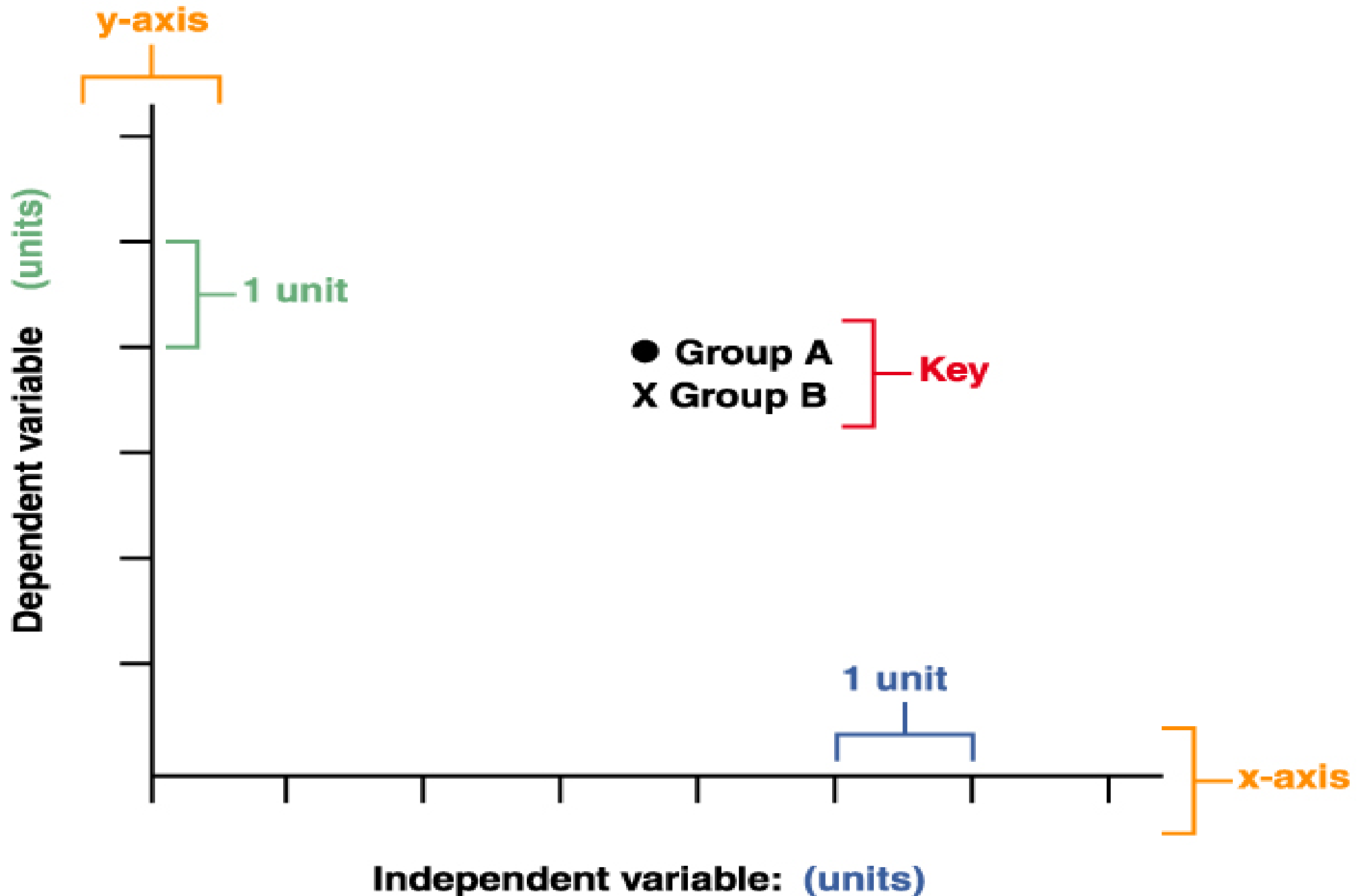

Legend — (Describes the information represented by the graph)

Line graph.The x-axis frequently represents time; the points represent individual observations. The points may be connected by lines, in which case the slope of the line between two points shows the rate at which the variable changed.

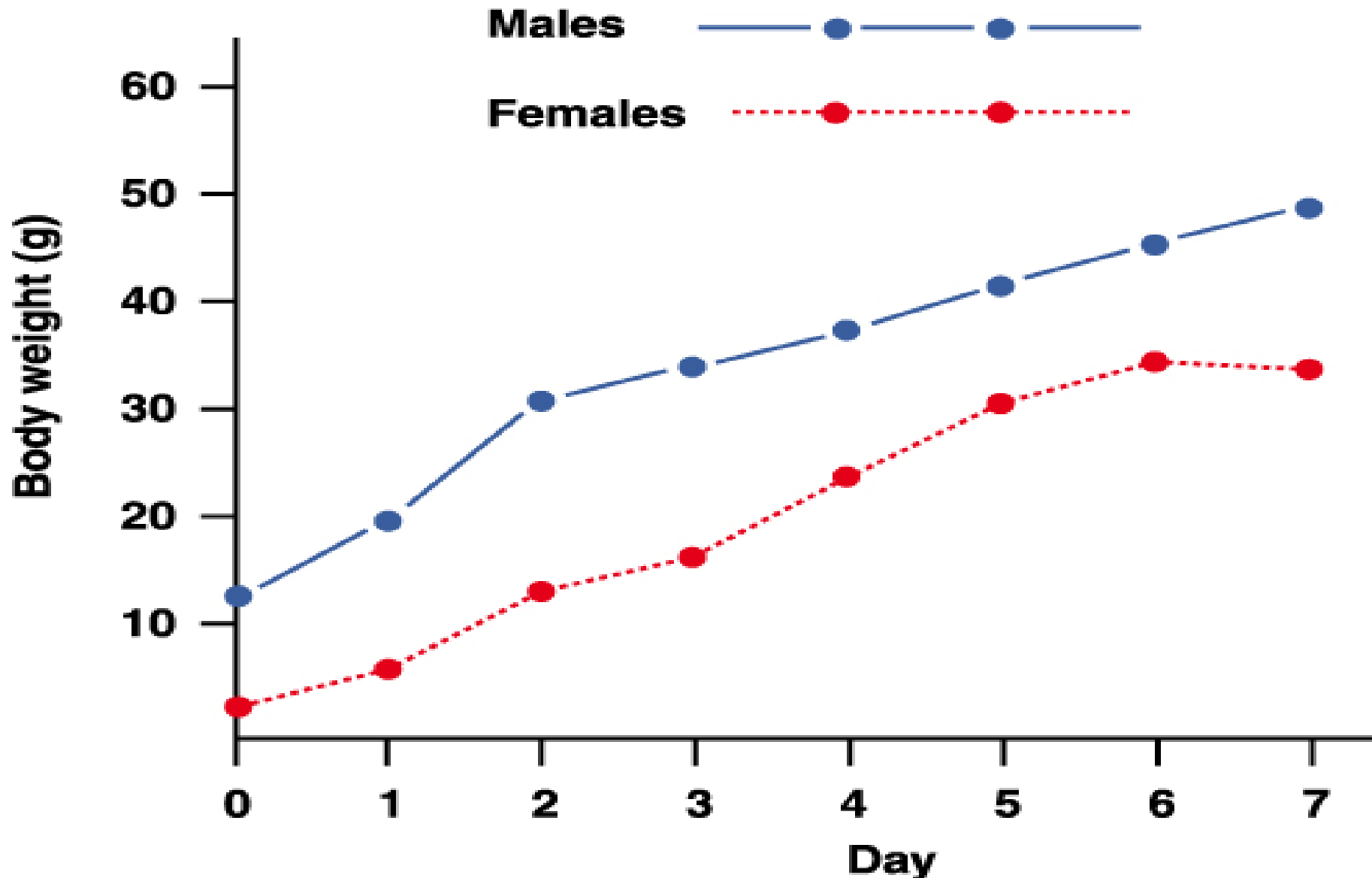

Male and female mice were fed a standard diet and weighed daily.

Bar graph. Each bar shows a fixed number or amount of a variable. The bars are lined up side by side along one axis so that they can be easily compared with one another. Scientific bar graphs traditionally have the bars running vertically.

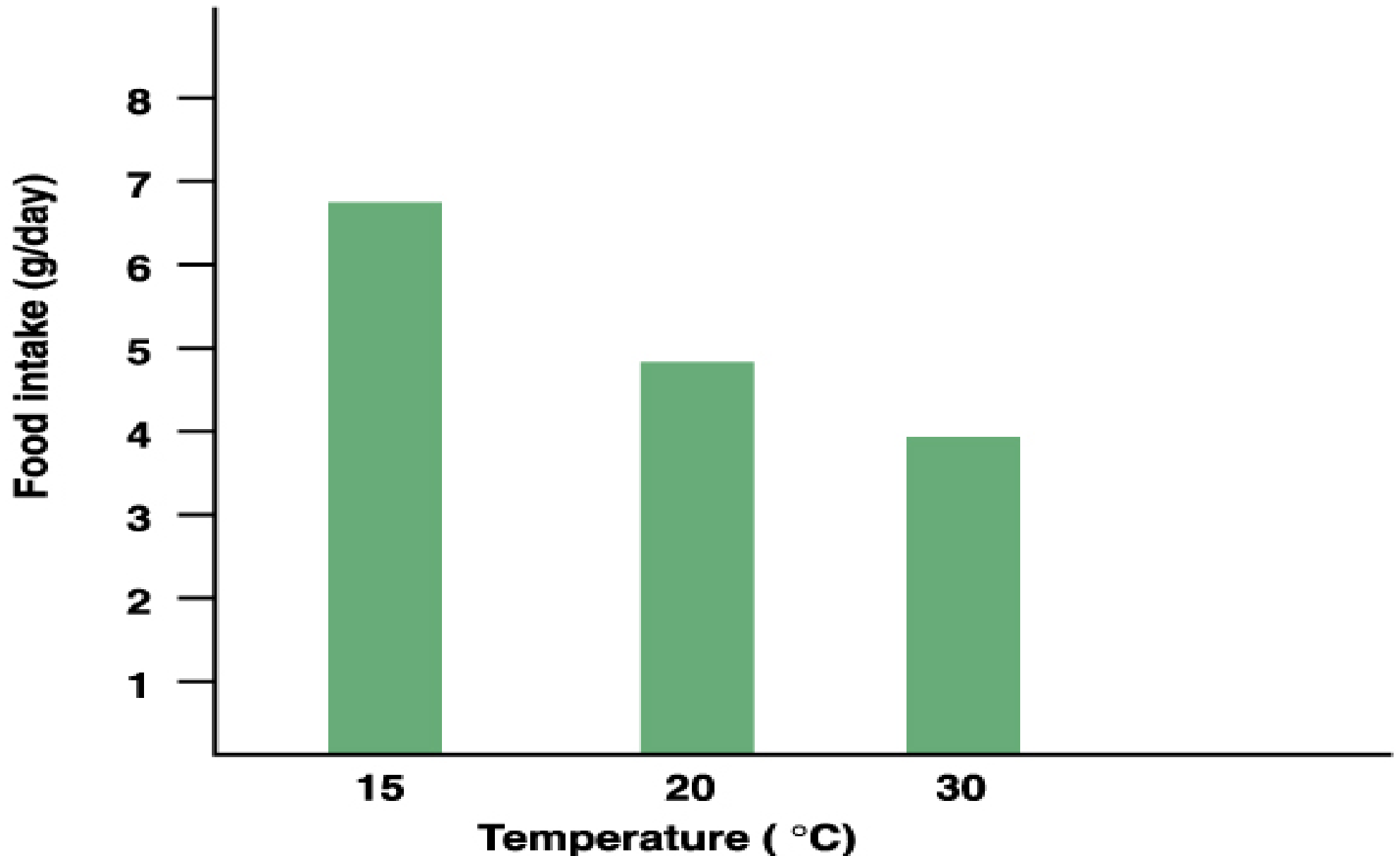

Canaries were acclimated to the temperatures shown, and their food intake was monitored for three weeks.

Scatter plot. Each point represents one member of a test population. The individual points of a scatter plot are never connected by lines, but a best fit line may be estimated to show a trend in the data, or better yet, the line may be calculated by a mathematical equation.

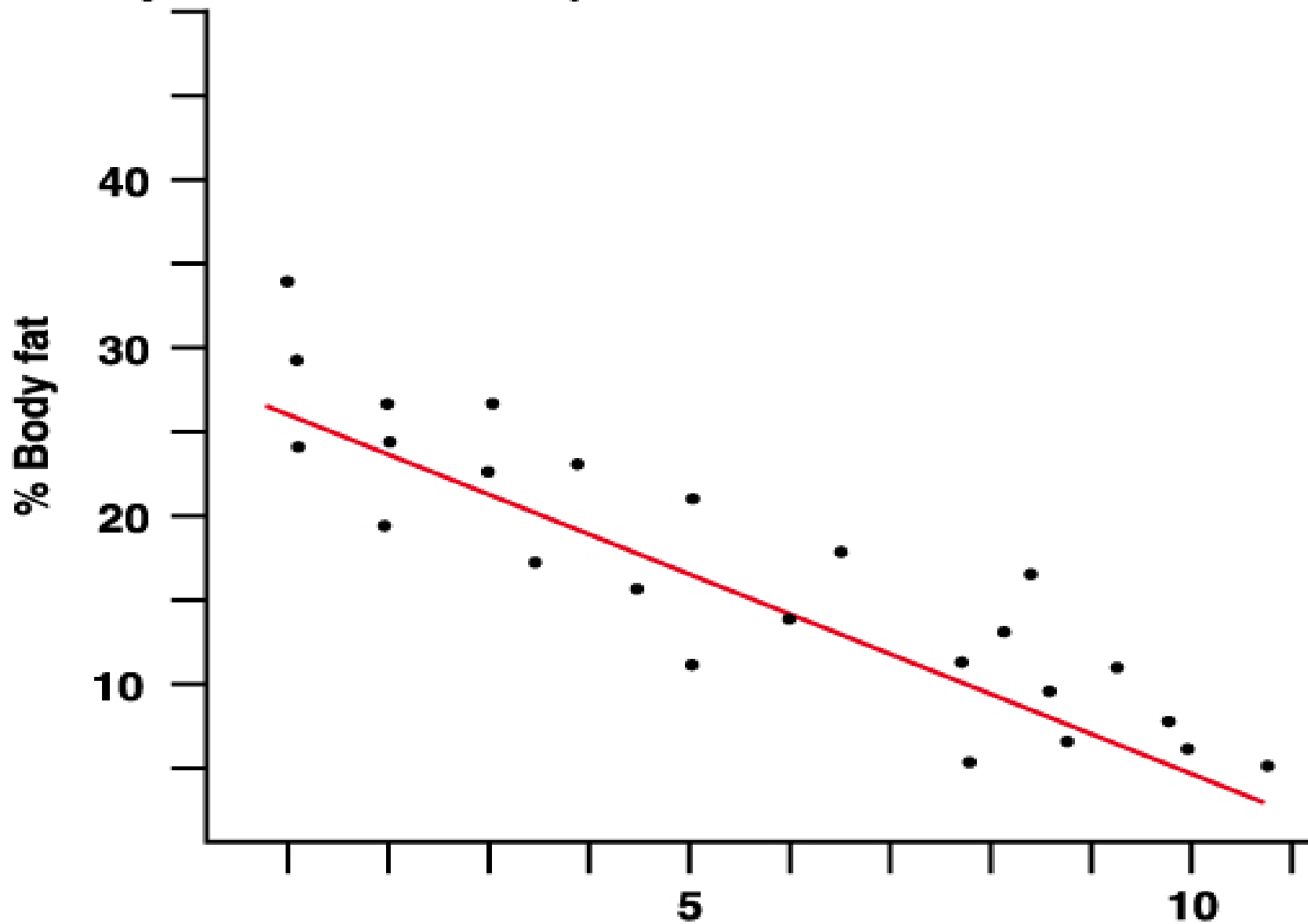

Increase in lean muscle mass (kg)
Male college students participated
in a ten-week weight training class.

③ *Energy Flow and Law of Mass Balance*

All living processes require constant input of energy

Where from? –

How is it stored?

How is it used to do work?

1.5. Energy

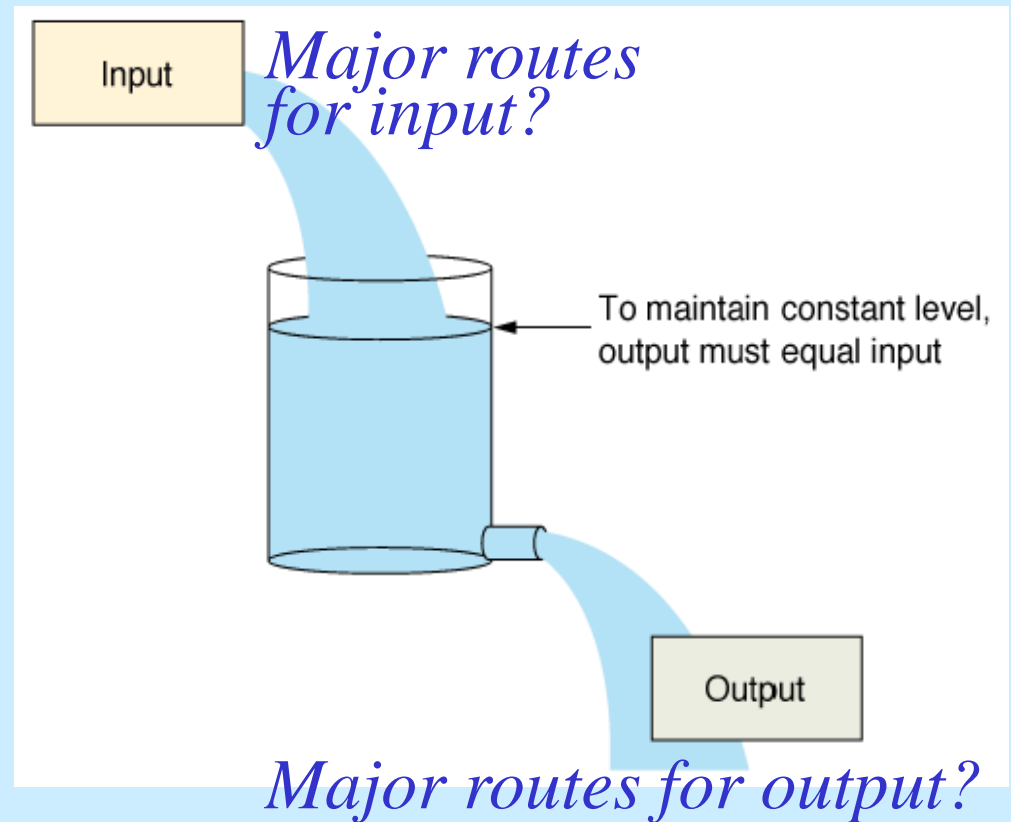

Total amount of substance in body = intake + production - output

What substances are maintained through law of mass balance?

A. Activation energy (E_a)

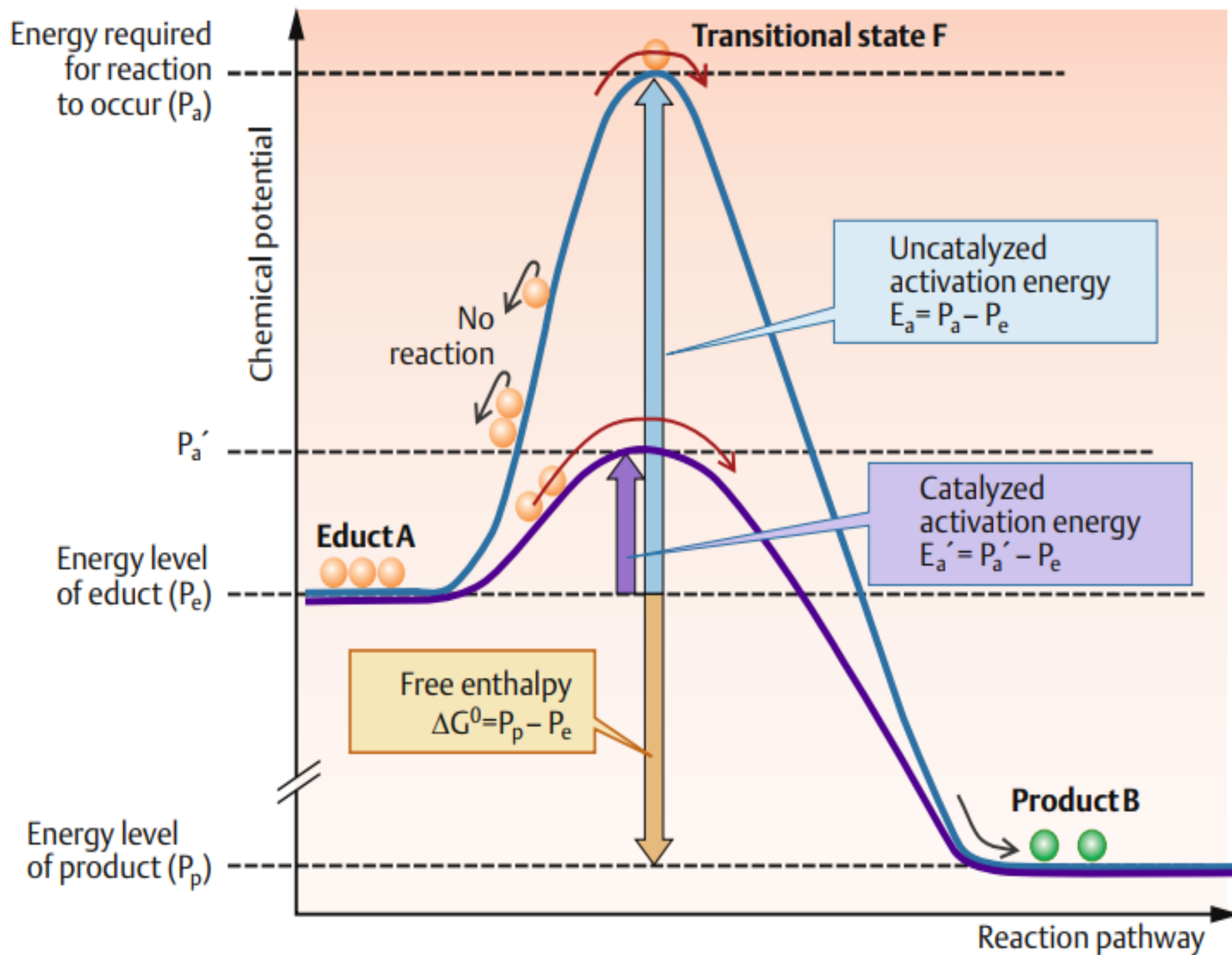

C. Aerobic ATP production

High-energy substrates:

Fats and
carbohydrates

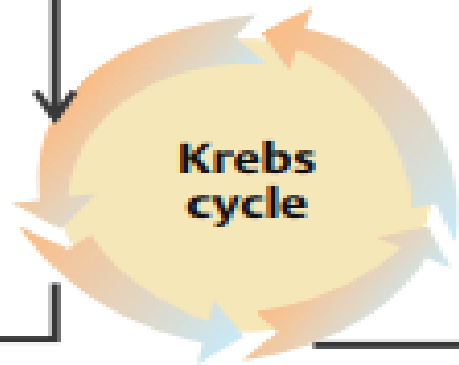

NADH

e^-

O_2

Respiratory chain

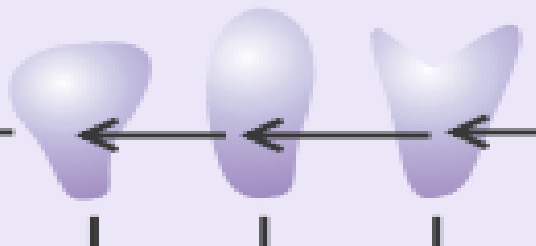

H^+

H^+

H^+

H^+ gradient

CO_2

H_2O

End products

ATP

(see plate 1.8B)

The free energy liberated upon hydrolysis of ATP is used to drive hundreds of reactions within the body, including the active transmembrane transport of various substances, protein synthesis, and muscle contraction. According to the laws of thermodynamics, the expenditure of energy in all of these reactions leads to increased order in living cells and, thus, in the organism as a whole. **Life is therefore characterized by the continuous reduction of entropy associated with a corresponding increase in entropy in the immediate environment and, ultimately, in the universe.**

Biochemical reactions are dependent on energy

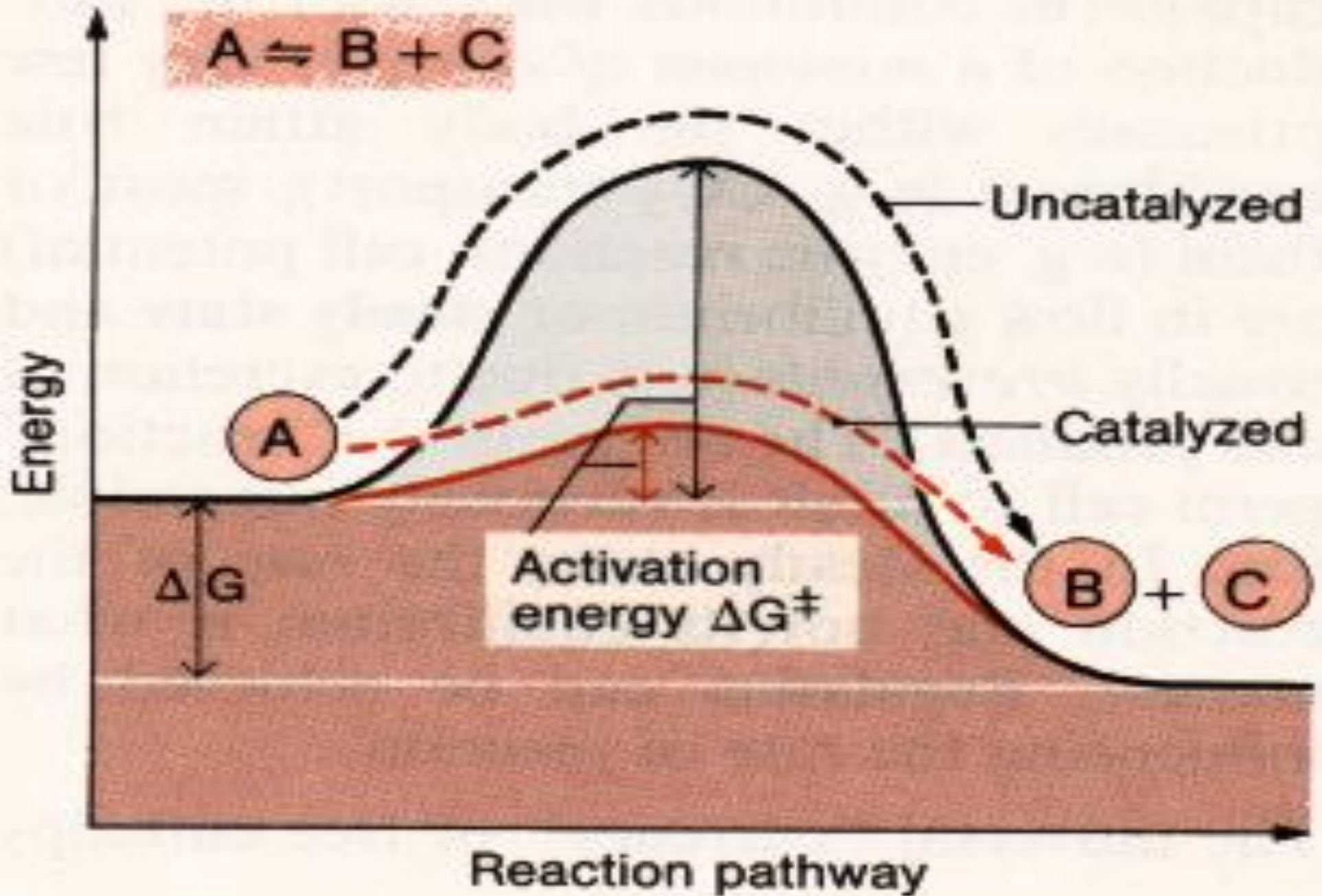

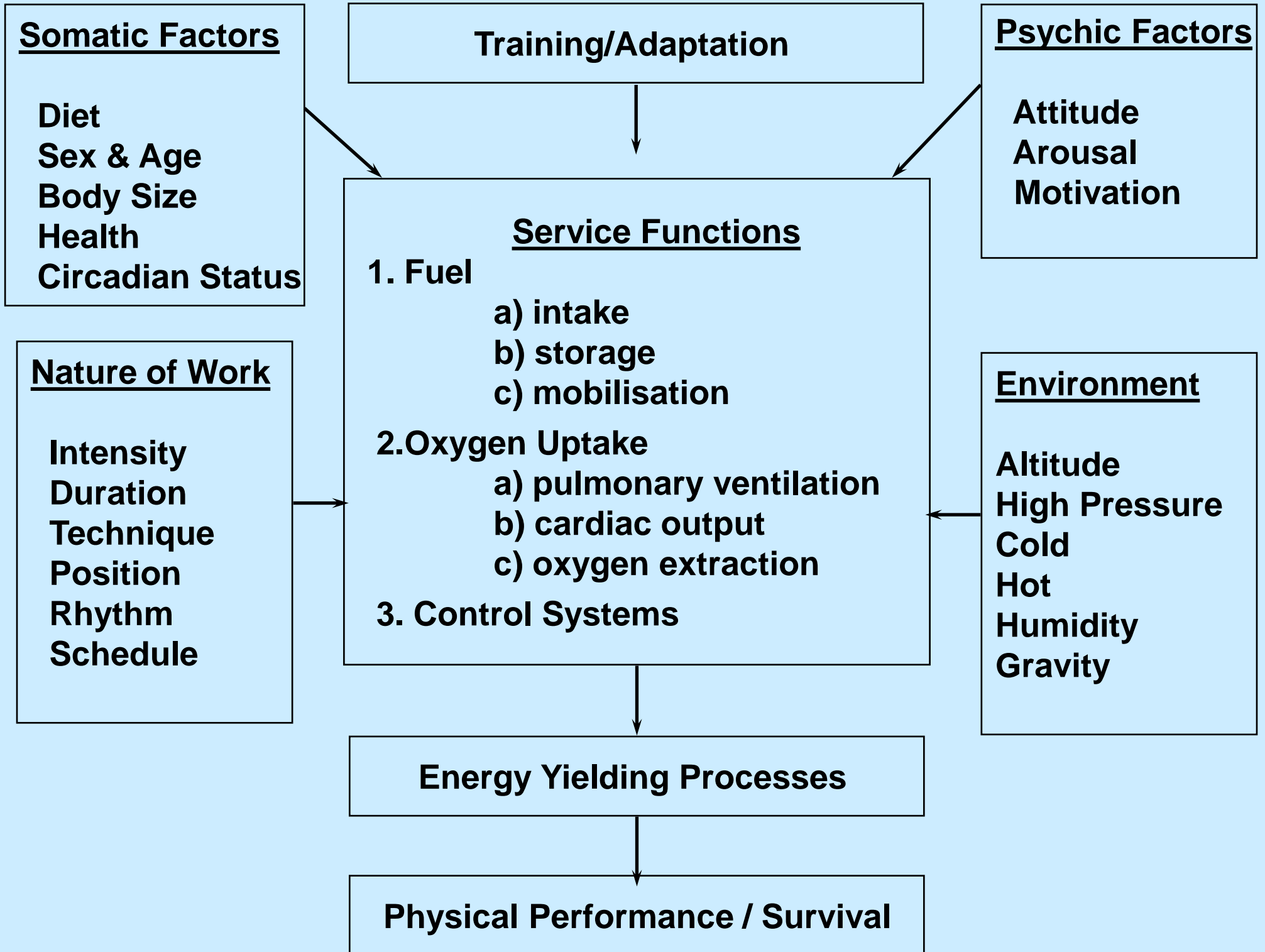

Energy Yielding Processes

1. Fuel

- a) intake**
- b) storage**
- c) mobilisation**

2. Oxygen Uptake

- a) pulmonary ventilation**
- b) cardiac output**
- c) oxygen extraction**

The ability of muscles to transform chemical energy to mechanical energy depends on the capacity of integrative physiological systems to deliver fuel and oxygen to the muscle cells.

Energy Metabolism in Cells

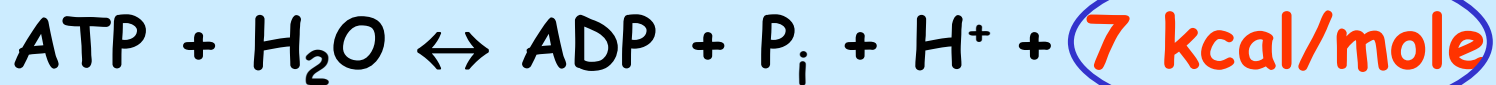

Anaerobic metabolism

Glycolysis



- Reactions take place in cytoplasm
- In absence of O_2 yields 2 ATP molecules/glucose

Aerobic metabolism

Oxidative phosphorylation

- Reactions take place in mitochondria in presence of O_2
- Formation of H_2O from H^+ (Krebs cycle) and $\text{O}_2 \Rightarrow \text{ATP}$
- Yields 38 ATP molecules/glucose

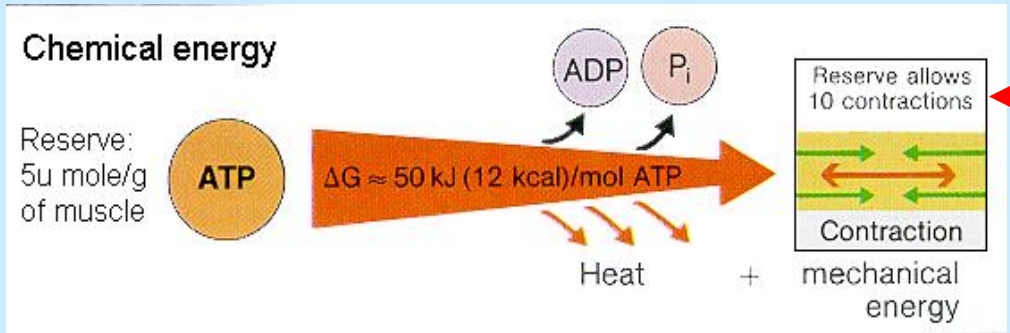

10 contractions

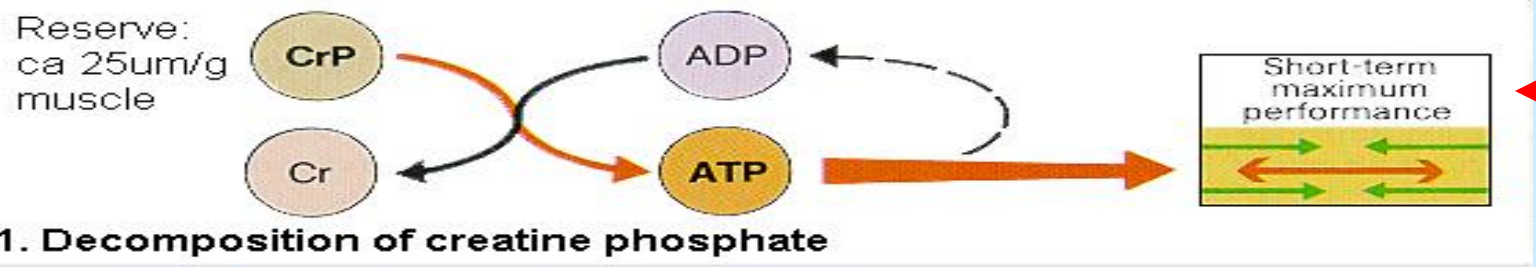

50 contractions

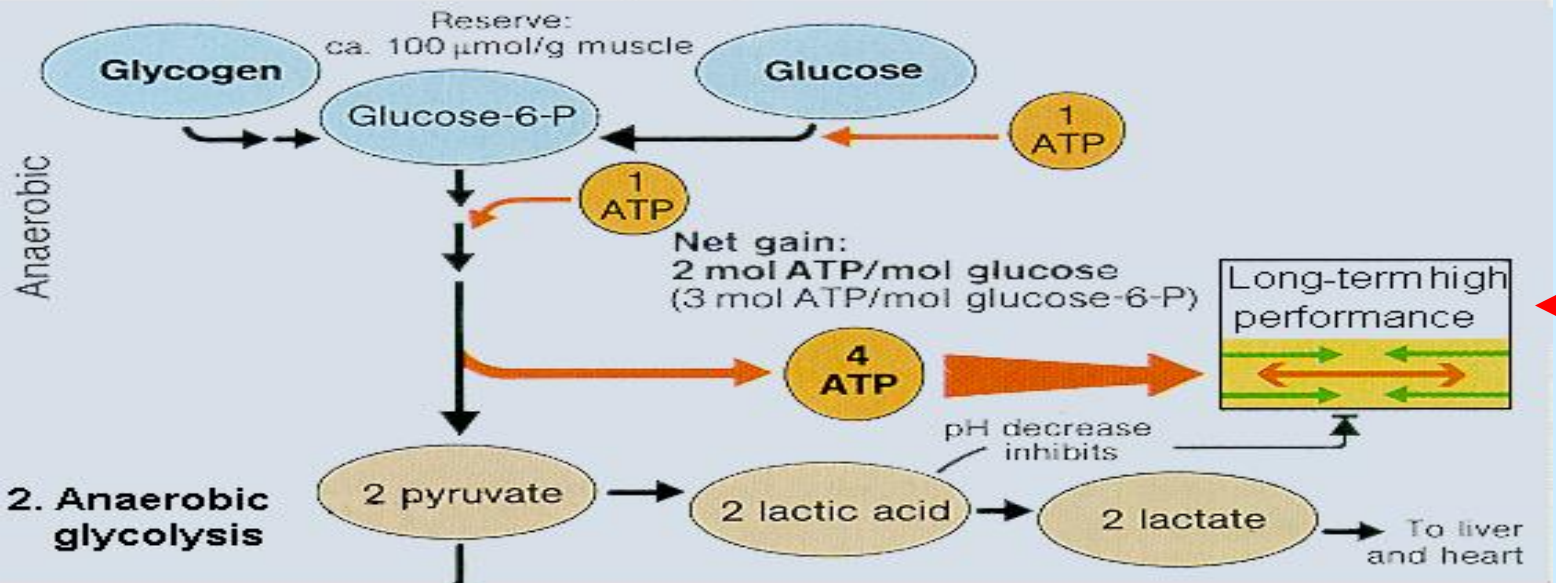

400 contractions

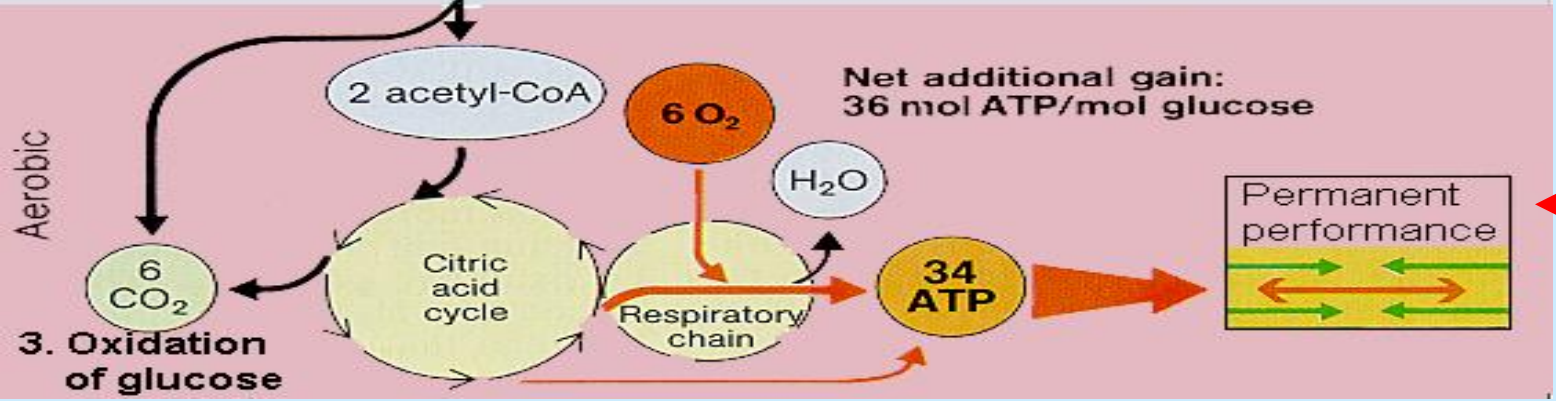

Unlimited

Having studied the mechanisms of survival ... let us **define life**

At the beach you spot a starfish.

How would you discover whether it is dead or alive?

- **Responsiveness** – alive organisms respond to changes in their environment
- **Adaptability** – Alive organisms have the ability to undergo long term changes in order to adapt to their environment.
- ...



What is life?

LIFE is the property or capacity distinguishing alive organisms from dead ones and from inert matter and which is expressed with endogenous functions, like...

- metabolism
- reproduction
- development
- responsiveness to stimuli
- adaptation to the environment
- ...

But ... it is not always so easy to define life
i.e. a car fulfills many of these requirements ...

- It responds to orders from the wheel and the brake
- it moves
- it consumes gasoline and transforms it to energy.

Is a virus alive?

The discovery of electrical excitability of tissues from a dead animal, produced the wrong impression than a live human can be created by assembling together all dead body parts and subjecting them to a strong electric shock. It was a fake news which lead to great social concerns , **What was the moral issue?**



*Look, it's moving. It's alive, it's alive, it's alive. It's moving
It's alive, it's alive, it's alive, it's alive, it's alive!*