

2-D Electrophoresis

Principles and Methods



Handbooks from GE Healthcare



GST Gene Fusion System
Handbook
18-1157-58

Affinity Chromatography
Principles and Methods
18-1022-29

Antibody Purification
Handbook
18-1037-46

**Ion Exchange Chromatography and
Chromatofocusing**
Principles and Methods
11-0004-21

Cell Separation Media
Methodology and Applications
18-1115-69

Purifying Challenging Proteins
Principles and Methods
28-9095-31

Isolation of mononuclear cells
Methodology and Applications
18-1152-69

**High-throughput Process Development
with PreDictor Plates**
Principles and Methods
28-9403-58

Gel Filtration
Principles and Methods
18-1022-18

Recombinant Protein Purification Handbook
Principles and Methods
18-1142-75

Protein Purification
Handbook
18-1132-29

**Hydrophobic Interaction and
Reversed Phase Chromatography**
Principles and Methods
11-0012-69

**2-D Electrophoresis using
immobilized pH gradients**
Principles and Methods
80-6429-60

Microcarrier Cell Culture
Principles and Methods
18-1140-62

**Nucleic Acid Sample Preparation for
Downstream Analyses**
Principles and Methods
28-9624-00

2-D Electrophoresis

Principles and Methods

Preface

Despite alternative technologies that have emerged, 2-dimensional (2-D) electrophoresis is currently the only technique that can be routinely applied for parallel quantitative expression profiling of large sets of complex protein mixtures. Furthermore, it delivers a map of intact proteins that reflects changes in protein expression level, isoforms, or post-translational modifications. Last but not least, today's 2-D electrophoresis technology with immobilized pH gradients (IPGs) has overcome the former limitations of carrier-ampholyte-based 2-D electrophoresis with respect to reproducibility, handling, resolution, and separation of very acidic and/or basic proteins (NEPHGE). The development of IPGs up to pH 12 together with an optimized protocol has enabled the analysis of very alkaline proteins and the construction of the corresponding databases. Narrow-overlapping IPGs provide increased resolution ($\Delta pI = 0.001$) and, in combination with prefractionation methods, the potential for the detection of low-abundance proteins.

The technique of 2-D electrophoresis with IPG strips has been constantly refined. It is now readily available to many laboratories and is more or less routine. Moreover, Difference Gel Electrophoresis (DIGE) has proved to be a most powerful and exciting technique for the reliable detection and quantitation of differentially expressed proteins. However, there are still challenges with respect to proteomic samples that span an immense dynamic range of relative abundance and a variety of physicochemical properties including solubility, hydrophobicity/hydrophilicity, size, and/or charge. Consequently, sample preparation and prefractionation are actually in the focus of interest, combined with new instrumentation for multiple runs and high-throughput analysis. Is there perfection in view? There are still some challenges in the state-of-the-art technology of 2-D electrophoresis but less than often expected and repeatedly described.

It is my pleasure to introduce the third edition of a most successful manual on 2-D electrophoresis. It clearly describes the actual techniques for 2-D electrophoresis with IPG strips, which should be stringently controlled, and provides detailed protocols for newcomers as well as for experienced users. New techniques such as 2-D DIGE and different sample preparation methods are included. Finally, there is a most valuable comprehensive pictorial troubleshooting guide — just in case (Murphy's Law!) something went wrong.

Angelika Görg
Technical University of Munich, Germany

September 2004

Contents

Preface	2
Introduction	7
Introduction to this handbook.....	7
Introduction to 2-D electrophoresis.....	7
Symbols used in this handbook.....	8
A. First- and second-dimension electrophoresis with optimized systems	9
B. First- and second-dimension electrophoresis with a flatbed system.....	11
Equipment choices	12
Selecting an IEF system	12
Selecting a second-dimension system	13
Vertical systems.....	14
Multiphor II Electrophoresis System	14
Good laboratory practice.....	15
1. Sample preparation	17
1.0 General strategy.....	17
1.0.1 Cell disruption, protection from proteolysis, fractionation.....	17
1.0.2 Precipitation and removal of interfering substances.....	17
1.0.3 Additional aspects of sample preparation.....	18
1.0.4 General sample preparation guidelines.....	19
1.1 Methods of cell disruption	20
1.1.1 Gentle lysis methods.....	20
1.1.2 More vigorous lysis methods.....	21
1.1.3 Processing small tissue or cell samples using Sample Grinding Kit	21
1.1.4 Preparing samples from “difficult” protein sources	22
1.2 Protecting against proteolysis	23
1.2.1 Protease inhibition using Protease Inhibitor Mix	24
1.3 Fractionation of protein lysates.....	24
1.4 Precipitation procedures.....	25
1.4.1 Cleaning up samples using 2-D Clean-Up Kit.....	26
1.4.2 Resuspension of pellet.....	29
1.5 Other methods for removing contaminants	30
1.5.1 Desalting samples using Mini Dialysis Kit	32
1.5.2 Removing undesirable nucleic acids from samples using Nuclease Mix.....	34
1.5.3 Simultaneous DNA, RNA and protein isolation from undivided scarce samples.....	34
1.5.4 Using Albumin and IgG Removal Kit to improve 2-D electrophoresis of human serum	34
1.6 Composition of sample preparation solution	37
1.6.1 Components of sample preparation solutions.....	37
1.6.2 Examples of sample preparation solutions.....	38
1.7 Quantitating protein samples.....	38
1.7.1 Protein determination using 2-D Quant Kit	39
1.8 Sample loads.....	40
2. First-dimension isoelectric focusing (IEF)	41
2.0 Overview.....	41
2.1 Background to isoelectric focusing	41
2.2 Immobiline DryStrip gels	43
2.2.1 Choosing strip length	44

2.2.2	Choosing the pH gradient	45
2.2.3	Choosing an IPG Buffer.....	46
2.2.4	Estimating the pI of proteins.....	46
2.3	IEF using Ettan IPGphor 3 Isoelectric Focusing System and accessories.....	47
2.3.2	Ettan IPGphor 3 Manifold.....	48
2.3.3	IPGbox.....	51
2.3.4	Ettan IPGphor 3 Strip Holders	51
2.3.5	General cautions	51
2.4	Selecting sample application method.....	52
2.4.1	Rehydration loading	52
2.4.2	Use of Manifold.....	52
2.4.3	Paper-bridge loading	52
2.5	Recommended sample loads	53
2.6	Immobiline DryStrip gel rehydration solutions.....	53
2.6.1	Components of rehydration solution.....	54
2.6.2	Using DeStreak Rehydration Solution	55
2.6.3	Preparation of other rehydration solutions.....	57
2.7	Immobiline DryStrip Gel rehydration using accessories	57
2.8	Isoelectric focusing guidelines—Ettan IPGphor 3 System	63
2.8.1	Protocol examples—Ettan IPGphor 3 Isoelectric Focusing System.....	63
2.8.2	Running an Ettan IPGphor 3 protocol.....	63
2.8.3	Preservation of focused Immobiline DryStrip gels	67
2.9	Troubleshooting.....	68
3.	Second-dimension SDS-PAGE using vertical electrophoresis systems	71
3.0	Overview.....	71
3.1	Equilibrating Immobiline DryStrip gels.....	71
3.1.1	Equilibration solution components.....	71
3.1.2	Equilibrating Immobiline DryStrip gels	72
3.2	Background to SDS-PAGE.....	72
3.3	Electrophoresis using Ettan DALT Large Vertical electrophoresis systems.....	73
3.3.1	Preparing Ettan DALT system for electrophoresis using precast gels	74
3.3.2	Inserting DALT Gel 12.5 into DALT Precast Gel Cassette	76
3.3.3	Equilibrating Immobiline DryStrip gels	77
3.3.4	Applying equilibrated Immobiline DryStrip gels to SDS gels.....	77
3.3.5	Inserting gels into Ettan DALT electrophoresis units.....	78
3.3.6	Electrophoresis conditions with precast gels for both Ettan DALTsix and Ettan DALTwelve.....	80
3.3.7	Preparing lab-cast gels	80
3.3.8	Preparing Ettan DALT electrophoresis units for electrophoresis sing lab-cast gels	83
3.3.9	Equilibrating Immobiline DryStrip gels with lab-cast gels.....	83
3.3.10	Applying Immobiline DryStrip gels to lab-cast gels	83
3.3.11	Inserting lab-cast gels into Ettan DALT electrophoresis units	83
3.3.12	Electrophoresis conditions with lab-cast gels.....	83
3.3.13	Troubleshooting	83
3.4	Electrophoresis using other vertical electrophoresis systems	84
3.4.1	Preparing caster and gel sandwich for miniVE, SE 260, and SE 600 Ruby electrophoresis systems.....	84
3.4.2	Preparing lab-cast gels for miniVE, SE 260, and SE 600 Ruby electrophoresis systems.....	84

3.4.3	Preparing miniVE, SE 260, and SE 600 Ruby systems for electrophoresis	86
3.4.4	Equilibrating Immobiline DryStrip gels	86
3.4.5	Applying Immobiline DryStrip gels.....	87
3.4.6	Inserting gels into miniVE, SE 260, and SE 600 Ruby systems.....	87
3.4.7	Electrophoresis conditions	87
3.5	Troubleshooting	88
4.	Use of the flatbed Multiphor II Electrophoresis System for first and second dimensions	91
4.0	Overview.....	91
4.1	First-dimension IEF using Multiphor II Electrophoresis System and Immobiline DryStrip Kit	91
4.1.1	Immobiline DryStrip gel rehydration—IPGbox	92
4.1.2	Preparing for IEF.....	93
4.1.3	Sample application by cup loading	94
4.1.4	Paper-bridge loading.....	95
4.1.5	IEF guidelines for Multiphor II Electrophoresis System.....	96
4.1.6	Protocol examples.....	96
4.1.7	Running a Multiphor II protocol	97
4.1.8	Preservation of focused Immobiline DryStrip gels	99
4.1.9	Troubleshooting	100
4.2	Second-Dimension SDS-PAGE using Multiphor II Electrophoresis System.....	101
4.2.1	ExcelGel preparation	101
4.2.2	Applying equilibrated Immobiline DryStrip gels.....	102
4.2.3	Electrophoresis conditions	103
4.2.4	Troubleshooting	104
5.	Visualizing and evaluating results	105
5.0	Visualizing results—labeling and staining	105
5.0.1	Automating processing and preserving the gel	106
5.1	Blotting	107
5.2	Evaluating results	107
5.3	Standardizing results	108
5.4	Further analysis of protein spots.....	108
5.4.1	Picking protein spots.....	108
5.4.2	Digesting proteins and spotting onto MALDI-ToF MS slides.....	108
5.4.3	MALDI-ToF mass spectrometry	108
6.	2-D Fluorescence Difference Gel Electrophoresis (2-D DIGE)	111
6.0	Overview.....	111
6.1	CyDye DIGE Fluor dyes.....	113
6.1.1	CyDye DIGE Fluor minimal dyes	113
6.1.2	Minimal labeling of protein with CyDye DIGE Fluor minimal dyes.....	114
6.2	CyDye DIGE Fluor labeling kits with saturation dyes for labeling scarce samples and preparative gels.....	114
6.3	Ettan DIGE system workflow	116
6.3.1	Experimental design for Ettan DIGE system applications.....	117
6.3.2	Sample preparation for Ettan DIGE system applications.....	119
6.3.3	Sample labeling with minimal dyes for Ettan DIGE system applications.....	120
6.3.4	Two-dimensional separation of protein samples.....	121
6.3.5	Summary of key differences between minimal labeling and saturation labeling	122
6.3.6	Imaging.....	122
6.3.7	Image analysis with DeCyder 2-D Differential Analysis Software	123
6.3.8	Further analysis of protein spots.....	123
6.4	Troubleshooting 2-D DIGE.....	124

7. Troubleshooting	125
Appendix I	129
Solutions.....	129
A. Sample preparation solution (with urea) for 2-D electrophoresis.....	129
B. Sample preparation solution (with urea and thiourea) for 2-D electrophoresis	129
C. Urea rehydration stock solution.....	130
D. Thiourea rehydration stock solution	130
E. SDS equilibration buffer solution.....	130
F. 10× Laemmli SDS electrophoresis buffer.....	131
G. 30% T, 2.6% C monomer stock solution	131
H. 4× resolving gel buffer solution.....	131
I. Bromophenol blue stock solution.....	131
J. 10% SDS solution	131
K. 10% ammonium persulfate solution.....	132
L. Gel storage solution	132
M. 1× Laemmli SDS electrophoresis buffer	132
N. Agarose sealing solution	132
Appendix II	133
Optimized silver staining of large-format DALT gels and DALT 12.5 precast gels using PlusOne Silver Staining Kit, Protein.....	133
Appendix III	135
Colloidal Coomassie staining procedure.....	135
5% Coomassie Blue G-250 stock.....	135
Colloidal Coomassie Blue G-250 dye stock solution.....	135
Colloidal Coomassie Blue G-250 working solution.....	135
Appendix IV	137
Appendix V	141
Treating glass plates with Bind-Silane.....	141
Appendix VI	143
Using Ready-Sol.....	143
References	145
Additional reading and reference material	149
Ordering information	151
Recommended additional consumables	159

Introduction

Introduction to this handbook

This handbook is intended to provide guidelines for performing high-resolution two-dimensional (2-D) electrophoresis. It is divided into seven chapters:

Chapter 1 provides guidelines for sample preparation and protein quantitation.

Chapter 2 details procedures for performing the first dimension of 2-D electrophoresis, highlighting use of Ettan™ IPGphor™ 3 Isoelectric Focusing System.

Chapter 3 contains general directions for subsequent second-dimension electrophoresis of immobilized pH gradient (IPG) strips using various vertical gel electrophoresis systems.

Chapter 4 describes use of the flatbed Multiphor™ II Electrophoresis System for both first- and second-dimension electrophoresis.

Chapter 5 discusses visualization and analysis of 2-D electrophoresis results.

Chapter 6 describes the advantages and use of the technique of 2-D Fluorescence Difference Gel Electrophoresis (2-D DIGE).

Chapter 7 describes common problems in 2-D gel electrophoresis and their remedies. Technique-specific troubleshooting guides are included in the relevant chapters.

The protocols described in this handbook are performed using products from Amersham Biosciences, now a part of GE Healthcare (referred to hereafter as GE Healthcare). Equipment choices are illustrated in Table 1. Product ordering information is given on page 155.

Depending on the sample type and the nature of the investigation, the procedures may need to be adjusted or optimized.

Introduction to 2-D electrophoresis

2-D electrophoresis is a powerful and widely used method for the analysis of complex protein mixtures extracted from cells, tissues, or other biological samples. This technique separates proteins according to two independent properties in two discrete steps.

The first-dimension step, isoelectric focusing (IEF), separates proteins according to their isoelectric points (pI); the second-dimension step, sodium dodecyl sulfate-polyacrylamide gel electrophoresis (SDS-PAGE), separates proteins according to their molecular weights (M_r , relative molecular mass). Each spot on the resulting two-dimensional gel potentially corresponds to a single protein species in the sample. Thousands of different proteins can thus be separated, and information such as the protein pI, the apparent molecular weight, and the amount of each protein can be obtained.

Two-dimensional electrophoresis was first introduced by O'Farrell (1) in 1975. In the original technique, the first-dimension separation was performed in carrier-ampholyte-containing polyacrylamide gels cast in narrow tubes. See section 2.1 on page 43 for more details.

The power of 2-D electrophoresis as a biochemical separation technique has been recognized virtually since its introduction. Its application, however, has become significant as a result of a number of developments:

- The introduction of immobilized pH gradients and Immobiline™ reagents (2) brought superior resolution and reproducibility to first-dimension IEF. Based on this concept, Görg and colleagues (3,4) developed the currently employed 2-D technique, where carrier-ampholyte-generated pH gradients have been replaced with immobilized pH gradients, and tube gels replaced with gels supported by a plastic backing. A more detailed discussion of the merits of this technique is presented in section 2.2 on page 45.
- 2-D DIGE, first described in 1997 by Ünlü et al. (5), offers a method for controlling system variations, allowing biological variations and changes in protein expression to be identified with statistical confidence.

- Automation of steps after 2-D electrophoresis, such as gel image analysis, spot picking, spot digestion, and target preparation for mass spectrometry, have allowed a significant increase in the throughput of protein analysis and identification.
- New mass spectrometry techniques have been developed that allow rapid identification and characterization of very small quantities of peptides and proteins.
- More powerful, less expensive computers and software are now available, rendering thorough computerized evaluations of highly complex 2-D patterns to become economically feasible.
- Data about entire genomes of a number of organisms are now available, allowing rapid identification of the gene encoding a protein separated by 2-D electrophoresis.
- Protein sequences are being added on a daily basis to databases available on the public domain. Organizations such as the Human Proteome Organization (HUPO) are attempting to coordinate proteome analysis between many countries toward a common goal.
- The World Wide Web provides simple, direct access to spot-pattern databases for the comparison of electrophoresis results and genome sequence databases for assignment of sequence information.

A large and growing application of 2-D electrophoresis is within the field of proteomics (6,7). The analysis involves the systematic separation, identification, and quantitation of many proteins simultaneously from a single sample. Two-dimensional electrophoresis is used in this field due to its unparalleled ability to separate thousands of proteins simultaneously. The technique is also unique in its ability to detect post- and co-translational modifications, which cannot be predicted from the genome sequence. Applications of 2-D electrophoresis include proteome analysis, cell differentiation, detection of disease markers, therapy monitoring, drug discovery, cancer research, purity checks, and microscale protein purification. This handbook describes methods for 2-D electrophoresis using precast IPG strips (Immobiline DryStrip gels) available from GE Healthcare.

Symbols used in this handbook



This symbol indicates general advice that can improve procedures or provide recommendations for action under specific situations.



This symbol denotes advice that should be regarded as mandatory and gives a warning when special care should be taken.



This symbol highlights troubleshooting advice to help analyze and resolve difficulties that may occur.



chemicals, buffers and equipment



experimental protocol

Table 1. Equipment choices for 2-D electrophoresis.

A. First- and second-dimension electrophoresis with optimized systems

First-dimension IEF using Ettan IPGphor 3 Isoelectric Focusing System

Gel sizes are given as gel width × separation length.

Ettan IPGphor 3 Isoelectric Focusing System with Ettan IPGphor Manifold or Standard Strip Holder

Note: The original IPGphor is fully compatible with the Manifold and with the protocols described throughout this handbook.



Fig 1. Ettan IPGphor 3 Isoelectric Focusing System.

Choice Factors:

- Unique design of Ettan IPGphor 3 Manifold allows IEF of up to 12 IPG strips, from 7 to 24 cm in length, with subsequent equilibration of the strips.
- Protein-focusing patterns can be improved using cup-based sample application, particularly in basic IPG strips.
- Manifold tray base is made of a thermally conductive aluminum oxide ceramic that rapidly dissipates heat to avoid “hot spots.”
- Voltage, current, temperature, and time controls are programmable.
- Integral control software—with an external personal computer (Windows™) connected via a serial port—can be used to control up to four Ettan IPGphor 3 units simultaneously, each running a different set of run parameters.
- Up to 10 protocols (nine steps each) can be saved, retrieved, and easily edited on the instrument.

Second-dimension SDS-PAGE using various vertical electrophoresis systems

Ettan DALTsix Large Vertical System, up to six 26 × 20 cm gels



Fig 2. Ettan DALTsix Large Vertical System.

Choice Factors:

- Four-hour to overnight electrophoresis.
- Modular system.
- Precast gels with stable buffer system available, cast on film support: Ettan DALT Gel 12.5 (25.5 × 19.6 cm, 1 mm thickness).
- Large-format gels for highest resolution and maximum protein load.
- Medium throughput (up to six gels simultaneously).
- Best for 18- and 24-cm IPG strips.
- Buffer volume approximately 5 l for six gels.

Ettan DALTwelve Large Vertical System, up to twelve 26 × 20 cm gels



Fig 3. Ettan DALTwelve Large Vertical System.

Choice Factors:

- Four-hour to overnight electrophoresis.
- Integrated system with very efficient Peltier temperature control.
- Precast gels with stable buffer system available, cast on film support: Ettan DALT Gel 12.5 (25.5 × 19.6 cm, 1 mm thickness),
- Large-format gels for highest resolution and maximum protein load.
- High throughput (up to 12 gels simultaneously).
- Best for 18- and 24-cm IPG strips.
- Buffer volume approximately 10 l for 12 gels.

miniVE and SE 260 (Mini-Vertical), one or two 8 × 7 or 9.5-cm gels



Fig 4. miniVE Vertical Electrophoresis System.

Choice Factors:

- Rapid: 1–2 h electrophoresis.
- Best for 7-cm IPG strips.
- Ideal when quick profiling is required or when the protein pattern is relatively simple.



Fig 5. SE 260.

SE 600 Ruby (standard vertical), one to four 14 × 16 cm gels



Fig 6. SE 600 Ruby.

Choice Factors:

- Electrophoresis in 2–5 h.
- Intermediate separation (16-cm gel length).
- Intermediate throughput (up to four gels simultaneously using divider plates).
- Best for 11- or 13-cm IPG strips.
- Optional short plates for higher throughput of 7-cm IPG strips (up to eight strips per run using divider plates).

B. First- and second-dimension electrophoresis with a flatbed system

First-dimension IEF using Multiphor II Electrophoresis System with Immobiline DryStrip Kit

Rehydration in IPGbox



Fig 7. Multiphor II Electrophoresis System with Immobiline DryStrip Kit.

Choice Factors:

- Can be used for both first- and second-dimension separations, as well as for many other electrophoresis techniques.
- Versatile system for IEF with IPG strips from 7 to 24 cm.
- Note: EPS 3501 XL Power Supply and MultiTemp™ III Thermostatic Circulator are required to supply power and cool the system, respectively.

Second-dimension SDS-PAGE using Multiphor II Electrophoresis System, one 24.5 × 11/18 cm gel

Choice Factors:

- Precast gels available: ExcelGel™ SDS Homogeneous 12.5 (24.5 × 11 cm) and ExcelGel Gradient XL 12–14 (24.5 × 18 cm).
- Relatively rapid: 4 h or less for electrophoresis.
- High resolution.

All available IPG strip lengths can be used.

The experimental sequence for 2-D electrophoresis is:

- 1. Sample preparation**

Proper sample preparation is absolutely essential for good 2-D results.

- 2. Immobiline DryStrip gel rehydration**

Immobiline DryStrip gels must be rehydrated with the appropriate additives prior to IEF.

- 3. IEF**

First-dimension IEF is performed on a flatbed system at very high voltages with active temperature control.

- 4. Immobiline DryStrip gel equilibration**

Strip equilibration in SDS-containing buffer prepares the sample for the second-dimension separation.

- 5. SDS-PAGE**

The strip is placed on the second-dimension gel for SDS-PAGE.

- 6. Visualization**

Protein spots are stained to visualize them in the second-dimension gel matrix. Alternatively, if the proteins were pre-labeled, the spots can be visualized by autoradiography, by illumination of the gel with UV light, or by using a fluorescence imager to detect the proteins.

- 7. Analysis**

Analysis of the resultant two-dimensional array of spots.

Equipment choices

There are different options for methods and equipment for IEF and SDS-PAGE. Table 1 lists the instruments available from GE Healthcare. For detailed information on the operation of any of the instruments described, refer to the respective instrument user manual. For other details about the instruments and related products, refer to the GE Healthcare BioDirectory or visit www.gehealthcare.com.

Selecting an IEF system

GE Healthcare offers two systems for first-dimension separation: Ettan IPGphor 3 Isoelectric Focusing System and Multiphor II Electrophoresis System. Both are available with accessories for improving IEF performance.

The upgraded, easy-to-use Ettan IPGphor 3 Isoelectric Focusing System (Fig 1) simplifies the first-dimension separation with a system dedicated to IEF on Immobiline DryStrip gels. Ettan IPGphor 3 consistently delivers speed and reproducibility, and can handle high protein loads. The system incorporates a safe, high-voltage (up to 10 000 V, depending on the DryStrip being used) power supply and Peltier solid-state temperature control (15–30 °C). Programmable parameters include rehydration temperature and duration, IEF temperature and maximum current, and the duration and voltage pattern of multiple steps for each separation.

In addition to the IEF unit, key accessories include Ettan IPGphor Manifold, Strip Holders, and IPGbox. Integral Ettan IPGphor 3 Control Software provides greater control in IEF runs; it can be used to control up to four Ettan IPGphor 3 units simultaneously, each running a different set of parameters. These accessories are discussed in detail in section 2.3.



For gradients at the upper and lower ends of the pH scale, as well as for very high protein loads on narrow-pH-range gradient strips, Ettan IPGphor 3 Manifold is employed for IEF using 7-, 11-, 13-, 18-, and 24-cm Immobiline DryStrip gels. Samples can be loaded onto IPG strips using sample cups, Ettan IPGphor 3 IPGbox, or paper bridges. Sections 2.3–2.5 discuss these options.

The versatile Multiphor II Electrophoresis System (Fig 7) can be used to perform several different electrophoresis techniques. An advantage of the Multiphor II Electrophoresis System for 2-D electrophoresis is the fact that it can be used for both first-dimension IEF and second-dimension SDS-PAGE. Strip rehydration with or without samples is performed in the Immobiline DryStrip IPGbox. After rehydration, the Immobiline DryStrip gels are transferred to the electrophoresis unit for first-dimension IEF.



The system is composed of the Multiphor II Electrophoresis System and Immobiline DryStrip Kit, which also allows cup and paper-bridge loading of the sample onto rehydrated Immobiline DryStrip gels (using Immobiline DryStrip IPGbox). This system accommodates up to 12 rehydrated Immobiline DryStrip gels of the same length for any one IEF protocol. Power is supplied by the separate EPS 3501 XL power supply, and temperature control by the separate MultiTemp III Thermostatic Circulator.

Table 2 shows the key operating differences between the Ettan IPGphor 3 Isoelectric Focusing System and Multiphor II Electrophoresis System for first-dimension IEF.

Table 2. IEF system selection.

	Maximum voltage	Additional equipment required	Time required for IEF*
Ettan IPGphor 3	10 000 V	Manifold plus Immobiline DryStrip IPGbox	2–36 h
Multiphor II	3500 V [†]	Immobiline DryStrip IPGbox Immobiline DryStrip Kit, EPS 3501 XL Power Supply, MultiTemp III Thermostatic Circulator	2–72 h

* Optimal focusing time varies widely depending on the Immobiline DryStrip gel length and pH range, and the nature of the sample. Similar separations can generally be performed at least two-fold faster with the Ettan IPGphor 3 Isoelectric Focusing System than with the Multiphor II Electrophoresis System.

[†] Higher voltages are not recommended for safety reasons.

Guidelines for the selection of sample application methods for Ettan IPGphor 3 Isoelectric Focusing System and Multiphor II Electrophoresis System and can be found in sections 2.4 and 4.1.3–4.1.4, respectively.

Selecting a second-dimension system

The second-dimension separation may be performed in a vertical or flatbed system. Table 3 lists the appropriate second-dimension system for a given gel size and Immobiline DryStrip gel length. Further considerations are discussed below. For a more complete discussion of the relative merits of vertical compared with flatbed second-dimension systems, see reference 8.

Table 3. Selection of second-dimension electrophoresis system with suggested Immobiline DryStrip and precast slab gels.

	Approx. gel size (w × l, cm)	Number of gels	Gel thickness (mm)	IPG strip length (cm)	Total separation time (h:m)
Vertical					
Ettan DALTsix*	26 × 20	1–6	1, 1.5	18, 24	4:00–6:30
Ettan DALTwelve*	26 × 20	1–12	1, 1.5	18, 24	5:00–7:00
miniVE or SE 260	8 × 9.5	1–2	1, 1.5	7	1:30
SE 600 Ruby	14 × 16	1–4 [‡]	1, 1.5	11	3:00–5:00
	16 × 16 [†]	1–4 [‡]	1, 1.5	13	3:00–5:00
	16 × 8 [§]	1–4 [‡]	1, 1.5	13	3:00–4:00
Flatbed					
Multiphor II					
ExcelGel 2-D Homogeneous 12.5*	24.5 × 11	1	0.5	all	1:45
ExcelGel Gradient XL 12–14*	24.5 × 18	1	0.5	all	3:20

* Multiple shorter Immobiline DryStrip gels (two 11-cm strips or three 7-cm strips) fit on one gel.

[†] If 1-cm-wide spacers are used.

[‡] An accessory divider plate increases the capacity to four gels.

[§] Up to eight mini-format separations can be simultaneously achieved using the shorter (8 cm) glass plates combined with divider plates.

Vertical systems

Vertical systems offer relative ease of use and the possibility of performing multiple separations simultaneously. Vertical 2-D gels can be either 1 or 1.5 mm thick.

Ettan DALTsix (Fig 2) allows intermediate throughput of up to six high-resolution second-dimension gels. The unit accommodates 18- or 24-cm Immobiline DryStrip gels that can be used with either precast or lab-cast large-format Ettan DALT gels. A pump mounted under the lower chamber recirculates buffer around the cassettes for efficient temperature regulation (in conjunction with MultiTemp III Thermostatic Circulator).

For maximal resolution, reproducibility, and capacity, the large-gel format of the Ettan DALTwelve system (Fig 3) is recommended. Precast large-format Ettan DALT gels on plastic film supports offer the convenience of ready-to-use gels. The system can accommodate the entire length of an 18- or 24-cm Immobiline DryStrip gel (plus molecular weight markers), and up to 12 gels can be run simultaneously. Integrated Peltier temperature control and a buffer circulation pump provide a precise and uniform thermal environment. Up to fourteen 1-mm-thick gels can be cast simultaneously in the Ettan DALTwelve Gel Caster.

For rapid results, the mini-gel units—miniVE (Fig 4) or SE 260 (Fig 5)—are recommended. The second-dimension separation is typically complete in 1–2 h. The use of mini-gels for the second dimension is ideal when quick profiling is required or when the protein pattern is relatively simple.

For increased throughput and resolution, the standard-sized SE 600 Ruby Vertical Electrophoresis System (Fig 6) is recommended. SE 600 Ruby accommodates up to four 16-cm-long gels and the built-in heat exchanger offers cooling capability (in conjunction with MultiTemp III Thermostatic Circulator) for increased reproducibility. The standard spacer width is 2 cm, giving a 14-cm-wide gel. If additional space for molecular weight markers is desired at both ends of a 13-cm Immobiline DryStrip gel, 1-cm-wide spacers are available for the preparation of 16-cm-wide gels. Short 8-cm clamps, plates, and spacers are available for preparing gels that are 14–16 cm wide and 8 cm long. These short gels may be used for rapid, simultaneous second-dimensional analysis of many 7-cm Immobiline DryStrip gels.

Multiphor II Electrophoresis System

The flatbed Multiphor II Electrophoresis System (Fig 7) provides excellent resolution and relatively rapid separations in a large-format gel. Precast ExcelGel products offer the convenience of ready-to-use gels and buffer strips.





The protein loading capacity of an Immobiline DryStrip gel can exceed the capacity of the thin, horizontal, second-dimension gel, so thicker vertical second-dimension gels are preferred for micropreparative separations.





The Multiphor Electrophoresis System is not recommended for the second-dimension step if pH 6–9, 6–11, or 7–11 NL Immobiline DryStrip gels have been used for the first-dimension separation.

Good laboratory practice

 Always wear gloves when handling Immobiline DryStrip gels, SDS polyacrylamide gels, ExcelGel Buffer Strips, and any equipment that these items will contact. The use of gloves will reduce protein contamination that can produce spurious spots or bands in 2-D patterns.

 Clean all assemblies that will be in contact with the gels or samples using a detergent designed for glassware, and rinse well with distilled water. This is particularly important when highly sensitive mass spectrometry techniques are employed for spot identification and characterization. A special detergent is available for the Strip Holders and Manifold (see chapter 2).

 Always use the highest quality reagents and the purest water available.

 Some of the chemicals used in the procedures—acrylamide, N,N'-methylenebisacrylamide, ammonium persulfate, TEMED, thiourea, DTT, iodoacetamide, and DeStreak™ Reagent—are very hazardous. Acrylamide monomer, for example, is a neurotoxin and suspected carcinogen. Read the manufacturer's safety data sheet (MSDS) detailing the properties and precautions for all chemicals in your laboratory. These safety data sheets should be reviewed prior to starting the procedures described in this handbook. General handling procedures for hazardous chemicals include using double latex gloves for all protocols. Hazardous materials should be weighed in a fume hood while wearing a disposable dust mask. Follow all local rules and regulations for handling and disposal of materials.

1. Sample preparation

1.0 General strategy

Appropriate sample preparation is absolutely essential for good 2-D electrophoresis results. Due to the great diversity of protein sample types and origins, the optimal sample preparation procedure for any given sample must be determined empirically. Ideally, the process will result in the complete solubilization, disaggregation, denaturation, and reduction of the proteins in the sample.

There are several important differences in sample preparation for 2-D Fluorescence Difference Gel Electrophoresis (2-D DIGE). See section 6.3.2 for more information.

When developing a sample preparation strategy, it is important to have a clear idea of what is desired in the final 2-D result. Is the goal to view as many proteins as possible, or is only a subset of the proteins in the sample of potential interest? Which is more important—complete sample representation or a clear, reproducible pattern? Additional sample preparation steps can improve the quality of the final result, but each additional step can result in the selective loss of protein species. The trade-off between improved sample quality and complete protein representation must therefore be carefully considered.

In order to characterize specific proteins in a complex protein mixture, the proteins of interest must be completely soluble under electrophoresis conditions. Different treatments and conditions are required to solubilize different types of protein samples; some proteins are naturally found in complexes with membranes, nucleic acids, or other proteins, some proteins form various nonspecific aggregates, and some proteins precipitate when removed from their normal environment. The effectiveness of solubilization depends on the choice of cell disruption method, protein concentration and dissolution method, choice of detergents, and composition of the sample solution. If any of these steps are not optimized for a particular sample, separations may be incomplete or distorted and information may be lost.

1.0.1 Cell disruption, protection from proteolysis, fractionation

To fully analyze all intracellular proteins, the cells must be effectively disrupted. Choice of disruption method depends on whether the sample is derived from cell suspensions, solid tissue, or other biological material and whether the analysis is targeting all proteins or just a particular subcellular fraction. Gentle and vigorous lysis methods are discussed in sections 1.1.1 and 1.1.2, respectively. A protocol for grinding cells using Sample Grinding Kit can be found in section 1.1.3.

Proteases may be liberated upon cell disruption. Proteolysis greatly complicates analysis of the 2-D gel result, thus the protein sample should be protected from proteolysis during cell disruption and subsequent preparation. Protease inhibition is discussed in section 1.2. Section 1.2.1 provides protocols for use of Protease Inhibitor Mix.

If only a subset of the proteins in a tissue or cell type is of interest, fractionation can be employed during sample preparation. If proteins from one particular subcellular compartment (e.g. nuclei, mitochondria, plasma membrane) are desired, the organelle of interest can be purified by differential centrifugation or other means prior to solubilization of proteins for 2-D electrophoresis. The sample can also be fractionated by solubility under different extraction conditions prior to 2-D electrophoresis (see references 9–13 for experimental conditions).

1.0.2 Precipitation and removal of interfering substances

In whole cell lysates, proteins are present in a wide dynamic range of concentrations. In such a situation, abundant proteins may mask identification of less abundant proteins of interest. An effective proteome analysis will naturally require separation of abundant proteins and enrichment of low-abundance proteins to bring the latter into detectable range. This allows for improved resolution when an individual fraction is analyzed, provides less crowded 2-D maps, simplifies analysis and interpretation, and increases the chances of discovering novel proteins of diagnostic or therapeutic interest.

Precipitation of the proteins in the sample and removal of interfering substances are optional steps. The decision to employ these steps depends on the nature of the sample and the experimental goal. Precipitation procedures, which are used both to concentrate the sample and to separate the proteins from potentially interfering substances, are described in section 1.4. Sections 1.4.1 provides protocols for sample clean-up using 2-D Clean-Up Kit.

Section 1.5 discusses the effects that contaminants (salts, small ionic molecules, albumin and IgG in human serum, ionic detergents, nucleic acids, polysaccharides, lipids, and phenolic compounds) might have on the 2-D result if they are not removed; the section also discusses removal techniques that eliminate specific contaminants from the sample. Protocols are provided for desalting using Mini Dialysis Kit (section 1.5.1), removing undesirable nucleic acids using Nuclease Mix (section 1.5.2), and eliminating problems associated with the presence of albumin and immunoglobulin G (IgG) from human plasma using Albumin and IgG Removal Kit (section 1.5.3).

In general, it is advisable to keep sample preparation as simple as possible. A sample with low protein concentration and a high salt concentration, for example, could be desalted then concentrated by lyophilization, or precipitated with TCA and ice-cold acetone and resolubilized with rehydration solution. In some instances the option of simply diluting the sample with rehydration solution may be sufficient. If problems with protein concentration or interfering substances are otherwise insurmountable, then precipitation or contaminant removal steps may be necessary.

1.0.3 Additional aspects of sample preparation

The composition of the sample solution is particularly critical for 2-D electrophoresis because solubilization treatments for the first-dimension separation must not affect the protein pI, or leave the sample in a highly conductive solution. In general, concentrated urea (or combinations of urea and thiourea) and one or more detergents are used. Sample solution composition is discussed in section 1.6.







Accurate quantitation of protein in samples prepared for electrophoresis can be difficult because many of the reagents used to prepare and solubilize samples for electrophoresis (e.g. chaotropes, carrier ampholytes, detergents, and reductants) are incompatible with common protein assays. Section 1.7 discusses this topic. Section 1.7.1 provides a protocol for using 2-D Quant Kit to overcome this problem.

The above-mentioned sample preparation kits from GE Healthcare simplify preparation procedures and improve sample quality, which is essential for obtaining good electrophoresis results. Table 4 summarizes the kits available; these kits are described in more detail in following sections of this chapter.

Table 4. Sample Preparation Kits.

Product	Quantity	Use
Sample Grinding Kit	50 samples	disrupts up to 100 mg tissue or cell sample
Protease Inhibitor Mix	1 ml	inhibits proteases
2-D Clean-Up Kit	50 samples	removes interfering material 1–100 μ l
Mini Dialysis Kit	50 samples	1 kDa cut-off, up to 250 μ l
Mini Dialysis Kit	50 samples	1 kDa cut-off, up to 2 ml
Mini Dialysis Kit	50 samples	8 kDa cut-off, up to 250 μ l
Mini Dialysis Kit	50 samples	8 kDa cut-off, up to 2 ml
Nuclease Mix	0.5 ml	removes nucleic acids
Albumin and IgG Removal Kit	10 samples	removes albumin and IgG from human serum
2-D Quant Kit	500 assays	quantitation of 1–50 μ l, up to 50 μ g protein
Vivaspin	25 pack	exchanges buffer and concentrates sample
2-D Protein Extraction Buffer Trial Kit	6 \times for 10 ml	prepares high quality protein lysates
illustra™ triplePrep Kit	50 preps	isolates simultaneously DNA, RNA and protein from the same sample

1.0.4 General sample preparation guidelines

-  Keep the sample preparation strategy as simple as possible to avoid protein losses. Additional sample preparation steps may improve the quality of the final 2-D result, but at the possible expense of selective protein loss.
-  Perform a literature search to determine if others have already worked out a sample preparation strategy. Discussion groups such as the one at www.gehealthcare.com can also be helpful.
-  The cells or tissue should be disrupted in such a way as to minimize proteolysis and other types of protein degradation. Cell disruption should be performed at as low a temperature as possible and with a minimum of heat generation. Cell disruption should ideally be carried out directly into a strongly denaturing solution containing protease inhibitors.
-  Preserve sample quality by preparing the sample just prior to IEF or storing samples in aliquots at -40 °C or below. Do not expose samples to repeated freezing and thawing.
-  Remove all particulate material by ultracentrifugation. Solid particles and lipids must be removed because they will block the pores in the electrophoresis gel.
-  To avoid modification of proteins, never heat a sample after adding urea. If the sample contains urea, the solution temperature must not exceed 37 °C. Elevated temperatures cause urea to hydrolyze to isocyanate, which modifies proteins by carbamylation, resulting in artifactual “charge trains.”
-  This chapter describes methods of sample preparation for 2-D electrophoresis using precast Immobiline DryStrip gels available from GE Healthcare. Optimal protein loads for Immobiline DryStrip gels are discussed in section 2.5. For more information on using Immobiline DryStrip gels and related equipment for IEF and 2-D electrophoresis, see chapters 2 and 3. For more specific guidance on preparing samples for application to Immobiline DryStrip gels, see references 14–16.

1.1 Methods of cell disruption

Tables 5 and 6 list some standard mechanical and chemical disruption methods. Cell disruption should be performed at low temperature; keep the sample on ice as much as possible and use chilled solutions.

Proteases may be liberated upon cell disruption, thus the protein sample should be protected from proteolysis if one of the methods described in this section is to be used. It is generally preferable to disrupt the sample material directly into a strongly denaturing lysis solution to rapidly inactivate proteases and other enzymatic activities that may modify proteins. Cell disruption is often carried out in an appropriate solubilization solution for the proteins of interest (see references 17 and 18 for general information on tissue disruption and cell lysis).

1.1.1 Gentle lysis methods

Gentle lysis methods are generally employed when the sample of interest consists of easily lysed cells (such as tissue culture cells, blood cells, and some microorganisms). Gentle lysis methods can also be employed when only one particular subcellular fraction is to be analyzed. For example, conditions can be chosen in which only cytoplasmic proteins are released, or intact mitochondria or other organelles are recovered by differential centrifugation. Sometimes these techniques are combined (e.g. osmotic lysis following enzymatic treatment, freeze-thaw in the presence of detergent). Table 5 summarizes various options for gentle lysis.

Table 5. Gentle lysis methods.

Cell disruption method	Application	General procedure
Osmotic lysis (19) This very gentle method is well-suited for applications in which the lysate is to be subsequently fractionated into subcellular components.	Blood cells, tissue culture cells	Suspend cells in a hypo-osmotic solution.
Freeze-thaw lysis (9, 17, 20) Many types of cells can be lysed by subjecting them to one or more cycles of quick freezing and subsequent thawing.	Bacterial cells, tissue culture cells	Rapidly freeze cell suspension using liquid nitrogen, then thaw. Repeat if necessary.
Detergent lysis (21, 22) Detergents solubilize cellular membranes, lysing cells and liberating their contents.	Tissue culture cells	Suspend cells in lysis solution containing detergent. Cells can often be lysed directly into sample solution or rehydration solution because these solutions always contain detergent. See appendix I, solution A for an example of a widely used lysis solution. Further examples of this technique are given in references 21 and 22. If an anionic detergent such as SDS is used for lysis, one of the following preparation steps is required to ensure that the SDS will not interfere with IEF: <ul style="list-style-type: none"> • Dilute the lysed sample with a solution containing an excess of nonionic or zwitterionic detergent OR <ul style="list-style-type: none"> • Separate the SDS from the sample protein by acetone precipitation.
Enzymatic lysis (23, 24) Cells with cell walls can be lysed gently following enzymatic removal of the cell wall. This must be done with an enzyme specific for the type of cell to be lysed (e.g. lysozyme for bacterial cells, cellulase and pectinase for plant cells, lyticase for yeast cells).	Plant tissue, bacterial cells, fungal cells	Treat cells with enzyme in an iso-osmotic solution.

1.1.2 More vigorous lysis methods

These methods are employed when cells are less easily disrupted, i.e. cells in solid tissues or cells with tough cell walls. More vigorous lysis methods will result in complete disruption of the cells, but care must be taken to avoid heating or foaming during these procedures. Table 6 summarizes these options.

Table 6. More vigorous lysis methods.

Cell disruption method	Application	General procedure
Sonication (5, 25, 26) Ultrasonic waves generated by a sonicator lyse cells through shear forces. Complete shearing is obtained when maximal agitation is achieved, but care must be taken to minimize heating and foaming.	Cell suspensions	Sonicate cell suspension in short bursts to avoid heating. Cool on ice between bursts.
French pressure cell (23, 24, 27) Cells are lysed by shear forces resulting from forcing suspension through a small orifice under high pressure.	Microorganisms with cell walls (bacteria, algae, yeasts)	Place cell suspension in chilled French pressure cell. Apply pressure and collect extruded lysate.
Grinding (5, 8, 28, 29) Some cell types can be lysed by grinding with a mortar and pestle.	Solid tissues, microorganisms	Tissue or cells are normally frozen with liquid nitrogen and ground to a fine powder. Alumina (Al_2O_3) or sand may aid grinding.
Mechanical homogenization (9, 19, 30–32) Many different devices can be used to mechanically homogenize tissues. Hand-held devices such as Dounce or Potter-Elvehjem homogenizers can be used to disrupt cell suspensions or relatively soft tissues. Blenders, or other motorized devices, can be used for larger samples. Homogenization is rapid and causes little damage to proteins except from the proteases that may be liberated upon disruption.	Solid tissues	Chop tissue into small pieces if necessary. Add chilled homogenization buffer (5–20 volumes to volume of tissue). Homogenize briefly. Clarify lysate by filtration and/or centrifugation.
Glass bead homogenization (23, 24, 33) The abrasive action of the vortexed beads breaks cell walls, liberating the cellular contents.	Cell suspensions, microorganisms	Suspend cells in an equal volume of chilled lysis solution and place into a sturdy tube. Add 1–3 g of chilled glass beads per gram of wet cells. Vortex for 1 min and incubate cells on ice 1 min. Repeat vortexing and chilling two to four times.

1.1.3 Processing small tissue or cell samples using Sample Grinding Kit

Sample Grinding Kit is designed to disrupt cell or tissue samples. It utilizes an abrasive grinding resin and grinding pestle to rupture cells for protein extraction. Intracellular organelles are also disrupted, resulting in the liberation and extraction of all proteins soluble in the extraction solution. Samples of 100 mg or less can be processed in as little as 10 min.

The kit contains fifty 1.5-ml microcentrifuge tubes, each containing a small quantity of abrasive grinding resin suspended in water. The tube is centrifuged to pellet the resin and the water is removed. The methodology is outlined in Figure 8.

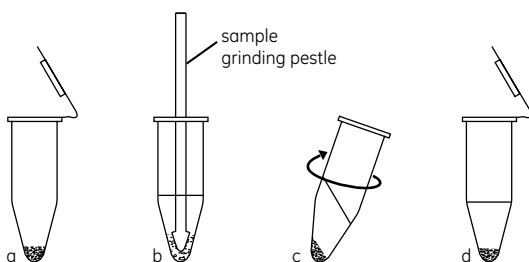

Fig 8. Schematic of the method used in the Sample Grinding Kit. (a) Pellet grinding resin in microcentrifuge tube. (b) Add sample and extraction solution. Disrupt sample by grinding with pestle. (c) Centrifuge to separate cellular debris and resin. (d) Collect supernatant.

The extraction solution of choice is added to the tube along with the sample to be ground. A disposable pestle is supplied to grind the sample. Immediately after grinding, cellular debris and grinding resin are removed by 5–10 min of centrifugation. If desired following extraction, the sample solution may be treated to remove interfering substances using 2-D Clean-Up Kit (see section 1.4.1).

Protocol: Sample Grinding Kit

Components supplied

Microcentrifuge grinding tubes containing grinding resin suspended in water, disposable pestles for sample grinding.

Required but not provided

Microcentrifuge capable of at least 12000 x g, vortex mixer, extraction solution.

Preliminary notes

Samples can be extracted into 8 M urea and 4% CHAPS, or into 7 M urea, 2 M thiourea, and 4% CHAPS (see solutions A and B in appendix I). Alternative nonionic detergents or protease inhibitors can be added during extraction. Carrier ampholytes (Pharmalyte™ reagents, Ampholines, or IPG Buffers) can be added at concentrations up to 2% for standard protocols but should not be added during protein extraction for labeling in 2-D DIGE.

1. Briefly centrifuge the grinding resin at maximum speed in the 1.5-ml microcentrifuge tubes provided in the kit (Fig 8A). Remove supernatant with micropipette.
2. Add sample (up to 100 mg) and extraction solution of choice (200–300 µl) (see appendix I, solutions A and B).



Tissue can be cut up with a scalpel or frozen with liquid nitrogen and broken with mortar and pestle to yield tissue fragments. Cell suspensions can be centrifuged with the grinding resin and resuspended in extraction solution.

3. Grind sample thoroughly (up to 1 min) with the disposable pestle included in the kit (Fig 8B).
4. Limit extraction solution to 200–300 µl during grinding to prevent liquid from splashing out of the tube. Additional extraction solution may be added to the tube following grinding (up to 1 ml).
5. Separate resin and debris by centrifugation for 5–10 min at maximum speed (Fig 8C).
6. Collect the supernatant and transfer to another tube (Fig 8D). If desired, proceed with further clean-up steps using 2-D Clean-Up Kit (section 1.4.1).

1.1.4 Preparing samples from "difficult" protein sources

To prepare proteins from tissues that are dilute sources of protein and contain high levels of interfering substances (e.g. plant tissues), the following procedure is recommended. This method produces protein solutions substantially free of salts, nucleic acids, and other contaminants:

1. Grind tissue in mortar and pestle with liquid nitrogen.
2. Suspend powder in 10% TCA with 0.3% DTT in acetone.
3. Keep at -18 °C overnight and centrifuge. Wash pellet with acetone.
4. Dry and resuspend in 9 M urea, 2% CHAPS, 1% DTT, 2% Pharmalyte 3–10 (52, 64).

Samples should remain in sample solution at room temperature for at least 30 min for full denaturation and solubilization prior to centrifugation and subsequent sample application. Heating of the sample in the presence of detergent can aid solubilization, but should only be done prior to the addition of urea. Sonication helps speed up solubilization, particularly from material that is otherwise difficult to resuspend.

1.2 Protecting against proteolysis

When cells are lysed, proteases are often liberated or activated. Degradation of proteins through protease action greatly complicates the analysis of 2-D electrophoresis results, so measures should be taken to avoid this problem. If possible, inhibit proteases by disrupting the sample directly into strong denaturants such as 8 M urea, 10% TCA, or 2% SDS (34–38). Proteases are less active at lower temperatures, so sample preparation should be carried out at as low a temperature as possible. In addition, proteolysis can often be inhibited by preparing the sample in the presence of Tris, sodium carbonate, or basic carrier ampholyte mixtures.

These approaches alone often provide sufficient protection against proteolysis. However, some proteases may retain activity even under these conditions. In these cases, protease inhibitors may be used. Individual protease inhibitors are only active against specific classes of proteases, so it is usually advisable to use a combination of protease inhibitors. Broad-range protease inhibitor “cocktails” are available from a number of commercial sources. GE Healthcare offers Protease Inhibitor Mix; see section 1.2.1 for more details and a description of the protocol.

Table 7 lists common protease inhibitors and the proteases they inhibit. For a more comprehensive discussion of protease inhibition, see references 15, 31, and 39–43.

Table 7. Protease inhibitors.

Protease inhibitor	Effective against:	Limitations
PMSF (Phenylmethylsulfonyl fluoride) Most commonly used inhibitor. Use at concentrations up to 1 mM.	PMSF is an irreversible inhibitor that inactivates: <ul style="list-style-type: none"> • serine proteases • some cysteine proteases 	PMSF rapidly becomes inactive in aqueous solutions: Prepare just prior to use. PMSF may be less effective in the presence of thiol reagents such as DTT or 2-mercaptoethanol. This limitation can be overcome by disrupting the sample into PMSF-containing solution lacking thiol reagents. Thiol reagents can be added at a later stage. PMSF is very toxic.
AEBSF (Aminoethyl benzyldisulfonamide) (Aminoethyl benzyldisulfonamide) Protease Inhibitor) Use at concentrations up to 4 mM.	AEBSF is similar to PMSF in its inhibitory activity, but is more soluble and less toxic.	AEBSF-induced modifications can potentially alter the pI of a protein.
EDTA or EGTA Use at 1 mM.	These compounds inhibit metalloproteases by chelating free metal ions required for activity.	
Peptide protease inhibitors (e.g. leupeptin, pepstatin, aprotinin, bestatin) <ul style="list-style-type: none"> • reversible inhibitors • active in the presence of DTT • active at low concentrations under a variety of conditions Use at 2–20 µg/ml.	Leupeptin inhibits many serine and cysteine proteases. Pepstatin inhibits aspartyl proteases (e.g. acidic proteases such as pepsin). Aprotinin inhibits many serine proteases. Bestatin inhibits aminopeptidases.	Peptide protease inhibitors are: <ul style="list-style-type: none"> • expensive. • small peptides and thus may appear on the 2-D map, depending on the size range separated by the second-dimension gel. Pepstatin does not inhibit any proteases that are active at pH 9.
TLCK, TPCK (Tosyl lysine chloromethyl ketone, tosyl phenylalanine chloromethyl ketone) Use at 0.1–0.5 mM.	These compounds irreversibly inhibit many serine and cysteine proteases.	
Benzamidine Use at 1–3 mM.	Benzamidine inhibits serine proteases.	

1.2.1 Protease inhibition using Protease Inhibitor Mix

Protease Inhibitor Mix from GE Healthcare contains an optimized concentration of competitive and noncompetitive protease inhibitors that effectively inhibit serine, cysteine, metalloproteases, and calpain proteases. The kit is suitable for the protection of proteins during purification from animal tissues, plant tissues, yeast, and bacteria.

Protocol: Protease Inhibitor Mix

Reagents supplied

Protease Inhibitor Mix (100× solution), 1 ml.

Required but not provided

Microcentrifuge, vortex mixer, extraction solution.

Preliminary notes

Protease Inhibitor Mix is provided free of EDTA as some proteins require divalent cations such as Ca^{2+} , Mg^{2+} , or Mn^{2+} for their biological activity. In such circumstances, the presence of EDTA may be detrimental to sample protein activity.

Samples can be extracted into 8 M urea and 4% CHAPS, or into 7 M urea, 2 M thiourea, and 4% CHAPS (see solutions A and B in appendix I). Alternative nonionic detergents or protease inhibitors can be added during extraction. Carrier ampholytes (Pharmalytes, Ampholines, or IPG Buffers) can be added at concentrations up to 2% for standard protocols but should not be added during protein extraction for labeling in 2-D DIGE.

1. Allow the solution to warm to room temperature.
2. Vortex briefly before using, as the solution is in suspension form.
3. Dilute Protease Inhibitor Mix 1:100 (10 $\mu\text{l}/\text{ml}$) in an appropriate volume of extraction buffer or extract.

Further options

- If a higher potency of protease inhibition is required, add Protease Inhibitor Mix at a concentration of 20–30 $\mu\text{l}/\text{ml}$ to give a 2–3× final concentration.
- For the inhibition of metalloproteases, add EDTA directly in an appropriate volume of extraction buffer or extract to give a final concentration of 5 mM EDTA in the reaction.



EDTA must not be added if the solution is to be used in conjunction with Nuclease Mix, because EDTA acts as a nuclease inhibitor.

1.3 Fractionation of protein lysates

Proteome studies involving quantitative comparisons of total cell protein profiles from two or more experimental samples require methods for highly reproducible separation of cell or tissue protein extracts. 2-D gel electrophoresis is currently the only proven method for simultaneous separation of highly complex protein mixtures and quantitative comparison of changes in protein profiles of cells, tissues, or whole organisms.

Although 2-D electrophoresis gives the highest resolution of all available protein separation methods, a drawback when complex protein lysates are run on 2-D gels without prefractionation is that the resulting 2-D gel is crowded with spots, making interpretation of results difficult. Typically, a 2-D gel can yield anywhere between 1000 and 4000 spots under favorable conditions, but the presence of many of the most interesting proteins, particularly low-abundance proteins, can be masked. Where high protein loads are employed, such as with preparative 2-D gels, higher protein amount loaded onto the gel results in 2-D patterns having poorer resolution, with spots of very abundant proteins overlaying the spots of less abundant proteins. If the loads are increased even more, abundant proteins become predominant and the separation is poor.

Thus the greatest challenge in protein discovery and analysis of important proteins is the right sample preparation strategy for 2-D electrophoresis. Strategies for prefractionation of samples for 2-D electrophoresis appear to be the most promising approach for increasing the number of protein components that can be visualized in complex proteomes such as mammalian cells, tissues, and physiological fluids. In addition, removal of contaminants is part of the strategy. For this purpose, GE Healthcare provides the Albumin and IgG Removal Kit, which includes an affinity gel to selectively remove albumin and IgG contaminants in human serum 2-D maps. The use of Albumin and IgG Removal Kit to improve 2-D electrophoresis of human serum is described in detail in section 1.5.3.

1.4 Precipitation procedures

Protein precipitation is an optional step in sample preparation for 2-D electrophoresis. Precipitation, followed by resuspension in sample solution, is generally employed to selectively separate proteins in the sample from contaminating species such as salts, detergents, nucleic acids, lipids, etc., that would otherwise interfere with the 2-D result. Precipitation followed by resuspension can also be employed to prepare a concentrated protein sample from a dilute source (e.g. plant tissues, urine). Note, however, that no precipitation technique is completely efficient, and some proteins may not readily resuspend following precipitation. Thus, employing a precipitation step during sample preparation can alter the protein profile of a sample. When complete and accurate representation of all the proteins in a sample is of paramount interest, precipitation and resuspension should be avoided.

2-D Clean-Up Kit from GE Healthcare can be used to remove contaminating substances and improve the 2-D electrophoresis pattern. Proteins are precipitated with a combination of precipitation reagents while the interfering substances, such as nucleic acids, salts, lipids, or detergents, remain in solution. Samples can be resuspended in the desired denaturing solution for IEF. Each kit can process 50 samples of up to 100 µl each. Section 1.4.1 describes the kit and provides a protocol for use.

Table 8 lists some of the precipitation techniques that can be used. If sample preparation requires precipitation, typically only one precipitation technique is employed.

Table 8. Precipitation procedures.

Precipitation method	General procedure	Limitations
Ammonium sulfate precipitation ("Salting out") In the presence of high salt concentrations, proteins tend to aggregate and precipitate out of solution. Many potential contaminants (e.g. nucleic acids) will remain in solution.	Prepare protein so that the final concentration of the protein solution is > 1 mg/ml in a buffer solution that is > 50 mM and contains EDTA. Slowly add ammonium sulfate to the desired percent saturation (44) and stir for 10–30 min. Pellet proteins by centrifugation.	Many proteins remain soluble at high salt concentrations, so this method is not recommended when total protein representation is desired. This method can, however, be used for prefractionation or enrichment. Residual ammonium sulfate will interfere with IEF and must be removed (45). See section 1.5 on removal of salts.
TCA precipitation TCA (trichloroacetic acid) is a very effective protein precipitant.	TCA is added to the extract to a final concentration of 10–20% and the proteins are allowed to precipitate on ice for 30 min (46). Alternatively, tissue may be homogenized directly into 10–20% TCA (35, 47). This approach limits proteolysis and other protein modifications. Centrifuge and wash pellet with acetone or ethanol to remove residual TCA.	Proteins may be difficult to resolubilize and may not resolubilize completely. Residual TCA must be removed by extensive washing with acetone or ethanol. Extended exposure to this low pH solution may cause some protein degradation or modification.
Acetone precipitation This organic solvent is commonly used to precipitate proteins. Many organic-soluble contaminants (e.g. detergents, lipids) will remain in solution.	Add at least three volumes of ice-cold acetone to the extract. Allow proteins to precipitate at -20 °C for at least 2 h. Pellet proteins by centrifugation (46, 48–50). Residual acetone is removed by air-drying or lyophilization.	Incomplete recovery of all proteins. Compatibility of acetone with tubes may be an issue.
Precipitation with TCA in acetone The combination of TCA and acetone is commonly used to precipitate proteins during sample preparation for 2-D electrophoresis, and is more effective than either TCA or acetone alone.	Suspend lysed or disrupted sample in 10% TCA in acetone with either 0.07% 2-mercaptoethanol or 20 mM DTT. Precipitate proteins for at least 45 min at -20 °C. Pellet proteins by centrifugation and wash pellet with cold acetone containing either 0.07% 2-mercaptoethanol or 20 mM DTT. Remove residual acetone by air drying or lyophilization (5, 28, 34, 43, 51, 52).	Proteins may be difficult to resolubilize and may not resolubilize completely. Extended exposure to this low pH solution may cause some protein degradation or modification.

continues on following page

Table 8. Precipitation procedures (continued).

Precipitation method	General procedure	Limitations
Precipitation with ammonium acetate in methanol following phenol extraction This technique has proven useful with plant samples containing high levels of interfering substances.	Proteins in the sample are extracted into water- or buffer-saturated phenol. Proteins are precipitated from the phenol phase with 0.1 M ammonium acetate in methanol. The pellet is washed several times with ammonium acetate in methanol and then with acetone. Residual acetone is evaporated (42, 43, 47, 53).	The method is complicated and time consuming.

For an overview of precipitation techniques, see references 17, 18, and 44.

1.4.1 Cleaning up samples using 2-D Clean-Up Kit

2-D Clean-Up Kit is designed to prepare samples that would otherwise produce poor 2-D results due to high conductivity, high levels of interfering substances, or low concentration of protein.

Current methods of protein precipitation suffer from several significant disadvantages:

- Precipitation can be incomplete, resulting in the loss of proteins from the sample and introduction of bias into the 2-D result.
- The precipitated protein can be difficult to resuspend and often cannot be fully recovered.
- The precipitation procedure can itself introduce ions that interfere with first-dimension IEF.
- Precipitation can be time-consuming, requiring overnight incubation of the sample.

2-D Clean-Up Kit circumvents these disadvantages by providing a method for selectively precipitating protein for 2-D electrophoresis. Protein can be quantitatively precipitated from a variety of sources without interference from detergents, chaotropes, and other common reagents used to solubilize protein. Recovery is generally greater than 90%. The procedure does not result in spot gain or loss, or changes in spot position relative to untreated samples. The precipitated proteins are easily resuspended in 2-D sample solution. The procedure can be completed in less than one hour.

The overall quality of protein separation using 2-D Clean-Up Kit has been shown to be superior to that of samples prepared by precipitation with acetone (54). Preparation of protein samples with the kit reduces horizontal streaking, improves spot resolution, and increases the number of spots detected compared with samples treated by other means (Fig 9 and Table 9).

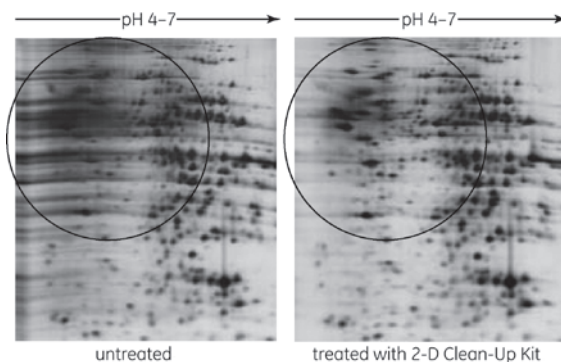

Fig 9. 2-D Clean-Up Kit eliminates horizontal streaking caused by residual SDS. Sample: Rat liver extracted with 4% SDS, 40 mM Tris base. First dimension: Approximately 20 μ g rat liver protein, 7-cm Immobiline DryStrip pH 4–7, Ettan IPGphor Isoelectric Focusing System 17.5 kVh. Second dimension: SDS-PAGE (12.5%), SE 260 (8 \times 9 cm gel). Stain: Silver Staining Kit, Protein.

Table 9. Effect of sample preparation on the number of protein spots detected in 2-D electrophoresis gels.

Sample preparation	Number of silver-stained spots*
Protein extracted with urea buffer†	726
Protein extracted with 1% Triton™ X-100 and precipitated with three volumes of acetone	758
Protein extracted with 1% Triton X-100 and purified using 2-D Clean-Up Kit	801

* Protein spots were detected using ImageMaster™ 2D Elite software.

† 9.8 M urea, 2% CHAPS, 0.5% IPG Buffer pH 3–10, 65 mM DTT.

The 2-D Clean-Up Kit procedure uses a combination of a unique precipitant and co-precipitant to quantitatively precipitate the sample proteins while leaving interfering substances behind in the solution. The proteins are pelleted by centrifugation and the precipitate is washed to further remove non-protein contaminants. The mixture is centrifuged again and the resultant pellet can be easily resuspended into a 2-D sample solution of choice, compatible with first-dimension IEF.

The kit contains sufficient reagents to process 50 samples of up to 100 µl each. The procedure can be scaled-up for larger volumes or more dilute samples.

Protocol: 2-D Clean-Up Kit

Reagents supplied

Precipitant, co-precipitant, wash buffer, wash additive.

Required but not provided

Ice bath, 1.5-ml capped microcentrifuge tubes, microcentrifuge capable of at least 12 000 × g, rehydration solution or IEF sample solution for resuspension (see next section), vortex mixer.

Preliminary notes



Procedure A is applicable for sample volumes of 1–100 µl containing 1–100 µg of protein. For larger samples containing more than 100 µg of protein, use procedure B.

Prior to starting the procedure, chill the wash buffer to -20 °C for at least 1 h.

A. For sample volumes of 1–100 µl (containing 1–100 µg of protein per sample)



Process the protein samples in 1.5-ml microcentrifuge tubes. All steps should be carried out on ice unless otherwise specified.

1. Transfer 1–100 µl of protein sample (containing 1–100 µg protein) into a 1.5-ml microcentrifuge tube.
2. Add 300 µl of precipitant. Mix well by vortexing or inversion. Incubate the tube on ice (4–5 °C) for 15 min.
3. Add 300 µl of co-precipitant to the mixture of protein and precipitant. Mix by vortexing briefly.
4. Position the tubes in a microcentrifuge with cap-hinges facing outward. Centrifuge at maximum speed (at least 12 000 × g) for 5 min. Remove the tubes from the microcentrifuge as soon as centrifugation has finished. A small pellet should be visible.
 Proceed rapidly to the next step to avoid resuspension or dispersion of the pellet.
5. Remove as much of the supernatant as possible by decanting or careful pipetting. Do not disturb the pellet.
6. Carefully reposition the tubes in the microcentrifuge with the cap-hinges and pellets facing outward. Centrifuge the tubes briefly to bring any remaining liquid to the bottom of the tubes. Use a pipette to remove the remaining supernatant. There should be no visible liquid remaining in the tubes.
7. Without disturbing the pellet, layer 40 µl of co-precipitant on top of each pellet. Incubate the tubes on ice for 5 min.
8. Carefully reposition the tubes in the centrifuge with the cap-hinges facing outward. Centrifuge for 5 min. Use a pipette to remove the supernatant.
9. Pipette 25 µl of distilled or deionized water on top of each pellet. Vortex each tube for 5–10 s. The pellet should disperse, but not dissolve in the water.

10. Add 1 ml of wash buffer (prechilled for at least 1 h at $-20\text{ }^{\circ}\text{C}$) and 5 μl of wash additive to each tube. Vortex until the pellets are fully dispersed.
Note: The protein pellet will not dissolve in the wash buffer.
11. Incubate the tubes at $-20\text{ }^{\circ}\text{C}$ for at least 30 min. Vortex for 20–30 s once every 10 min. At this stage, the tubes can be stored at $-20\text{ }^{\circ}\text{C}$ for up to one week with minimal protein degradation or modification.
12. Centrifuge the tubes at maximum speed (at least $12\,000 \times g$) for 5 min.
13. Carefully remove and discard the supernatant. A white pellet should be visible. Allow the pellet to air dry briefly (no more than 5 min).
 Do not over-dry the pellet. If it becomes too dry, it will be difficult to resuspend.
14. Resuspend each pellet in an appropriate volume of rehydration or IEF sample loading solution for first-dimension IEF. See next section for examples of rehydration solutions and volumes appropriate to different applications. Vortex the tubes for at least 30 s. Incubate at room temperature. Vortex or aspirate and dispense using a pipette to fully dissolve.
 If the pellet is large or too dry, it may be difficult to resuspend fully. Sonication or treatment with the Sample Grinding Kit (see section 1.1.3) can speed resuspension.
15. Centrifuge the tubes at maximum speed (at least $12\,000 \times g$) for 5 min to remove any insoluble material and to reduce any foam. The supernatant may be loaded directly onto first-dimension IEF or transferred to another tube and stored at $-80\text{ }^{\circ}\text{C}$ for later analysis.

B. For larger samples of more than 100 μg of protein

All steps should be carried out on ice unless otherwise specified.

1. Transfer the protein samples into tubes that can be centrifuged at $8000 \times g$. Each tube must have a capacity at least 12-fold greater than the volume of the sample. Use only polypropylene, polyallomer, or glass tubes.
 The wash buffer used later in the procedure is not compatible with many plastics. This limits the choice of centrifuge tube materials.
2. For each volume of sample, add three volumes of precipitant. Mix well by vortexing or inversion. Incubate on ice ($4\text{--}5\text{ }^{\circ}\text{C}$) for 15 min.
3. For each original volume of sample, add three volumes of co-precipitant to the mixture of protein and precipitant. Mix by vortexing briefly.
4. Position the tubes in a microcentrifuge with the cap-hinges facing outward. Centrifuge at $8000 \times g$ for 10 min. Remove the tubes from the microcentrifuge as soon as centrifugation has finished. A pellet should be visible.
 Proceed rapidly to the next step to avoid resuspension or diffusion of the pellet.
5. Remove as much of the supernatant as possible by decanting or careful pipetting. Do not disturb the pellet.
6. Carefully position the tubes in the microcentrifuge with the cap-hinges and pellets facing outward. Centrifuge the tubes for at least 1 min to bring any remaining liquid to the bottom of the tubes. Use a pipette to remove the remaining supernatant. There should be no visible liquid remaining in the tubes.
7. To each tube, add three-fold to four-fold more co-precipitant than the size of the pellet.
8. Carefully reposition the tubes in the microcentrifuge with the cap-hinges facing outward. Centrifuge for 5 min. Use a pipette to remove the supernatant.
9. Pipette enough distilled or deionized water on top of each pellet to cover the pellet. Vortex each tube for several seconds. The pellets should disperse, but not dissolve in the water.
10. Add 1 ml of wash buffer, prechilled for at least 1 h at $-20\text{ }^{\circ}\text{C}$ to each tube. (For an initial sample volume of 0.1–0.3 ml, add 1 ml of wash buffer. However, the volume of wash buffer must be at least 10-fold greater than the distilled/deionized water added in step 9.) Add 5 μl wash additive (use only 5 μl wash additive, regardless of the original sample volume). Vortex until the pellet is fully dispersed.
Note: The protein pellet will not dissolve in the wash buffer.
11. Incubate the tubes at $-20\text{ }^{\circ}\text{C}$ for at least 30 min. Vortex for 20–30 s once every 10 min. At this stage, the tubes can be stored at $-20\text{ }^{\circ}\text{C}$ for up to one week with minimal protein degradation or modification.
12. Centrifuge the tubes at $8000 \times g$ for 10 min.

13. Carefully remove and discard the supernatant. A white pellet should be visible. Allow the pellet to air dry briefly (no more than 5 min).



Do not over-dry the pellet. If it becomes too dry, it will be difficult to resuspend.

14. Resuspend each pellet in rehydration solution for first-dimension IEF. The volume of rehydration solution used can be as little as 1/20 of the volume of the original sample. See next section for examples of rehydration solutions and volumes appropriate for different applications. Vortex the tube for 30 s. Incubate at room temperature. Vortex or aspirate and dispense using a pipette to fully dissolve.



If the pellet is large or too dry, it may be difficult to resuspend fully. Sonication can speed resuspension.

15. Centrifuge the tubes at 8000 × g for 10 min to remove any insoluble material and to reduce any foam. The supernatant may be loaded directly onto first-dimension IEF or transferred to another tube and stored at -80 °C for later analysis.

1.4.2 Resuspension of pellet

2-D Clean-Up Kit produces a protein pellet. When using cup loading, resuspend the pellet in sample preparation solution (see appendix I). When using rehydration loading, resuspend the pellet in rehydration solution (see options 1 and 2 below), which is applied directly to the Immobiline DryStrip gel.

1. Rehydration solution containing 8 M urea

Use solution C in appendix I. This all-purpose solution gives clean, sharp 2-D separations.

2. Rehydration solution containing 7 M urea and 2 M thiourea

Use solution D in appendix I. This is a more strongly solubilizing solution that results in more spots in the final 2-D pattern.

Any other components added to the rehydration solution must either be uncharged or present at a concentration of less than 5 mM. The addition of salts, acids, bases, and buffers is not recommended.

3. DeStreak Reagent

Use for basic strips. See section 2.6.2 for details on the reagent.

Sample resuspension volumes

The volume of rehydration solution used to resuspend the sample depends on the sample loading method and the length of the Immobiline DryStrip gel used for the first-dimension separation. If using Ettan IPGphor 3 and the sample is to be loaded onto the Immobiline DryStrip gel using a sample cup, the sample volume should not exceed 150 µl. If the sample is to be loaded onto the Immobiline DryStrip gel by rehydration, the sample volumes shown in Table 10 should be used according to the length of the Immobiline DryStrip gel.

Table 10. Sample volumes for different Immobiline DryStrip gel lengths.

Immobiline DryStrip gel length (cm)	Sample volume applied (µl)
7	125
11	200
13	250
18	340
24	450

The optimal quantity of protein to load varies widely depending on factors such as sample complexity, the length and pH range of the Immobiline DryStrip gel, and the method of visualizing the 2-D gel separation. General guidelines are given in chapter 2.

The protein concentration of the sample is best determined using the 2-D Quant Kit, which can accurately quantitate protein in the presence of detergents, reductants, and other reagents used in sample preparation. See section 1.7 for details.

1.5 Other methods for removing contaminants

The first-dimension IEF step of 2-D electrophoresis is particularly sensitive to low-molecular-weight ionic impurities. Non-protein impurities in the sample can interfere with separation and subsequent visualization of the 2-D gel result, so sample preparation may require steps to rid the sample of these substances. Table 11 lists contaminants that affect 2-D results and techniques for their removal. Reference 9 provides further discussion on the removal of interfering substances. Mini Dialysis Kit, Albumin and IgG Removal Kit, and Nuclease Mix may be used to remove interfering substances that affect 2-D results. Refer to section 1.4.1 for a discussion of 2-D Clean-Up Kit, which selectively precipitates protein for 2-D analysis.



Salt contamination is the most frequent cause of insufficient focusing of protein spots.

Table 11. Contaminants that affect 2-D results.

Contaminant	Reason for removal	Removal techniques
Salts, residual buffers, and other charged small molecules that carry over from sample preparation.	Salts disturb the electrophoresis process and must be removed or maintained at as low a concentration as possible. Salts in the IPG strip result in high strip conductivity. Focusing of the proteins will not occur until the ions have moved to the ends of the strips, prolonging the time required for IEF. Water movement can also occur, causing one end of the strip to dry out and the other end to swell. Salt in the IPG strip can result in large regions at either end of the IPG strip where proteins do not focus (seen as horizontal streaking or empty regions in the final result). If the sample is rehydrated into the IPG strip, the salt concentration in the rehydration solution should be lower than 10 mM. If the sample is applied in sample cups, salt concentrations of up to 50 mM in the sample may be tolerated; however, proteins may precipitate at the sample application point as they abruptly move into a lower salt environment.	Desalting can be performed by: <ul style="list-style-type: none"> • dialysis • spin dialysis • gel filtration • precipitation/resuspension Dialysis is a very effective method for salt removal resulting in minimal sample loss. However, the process is time-consuming and requires large volumes of solution. Spin dialysis is quicker, but protein adsorption onto the dialysis membrane may be a problem. Spin dialysis should be applied to samples prior to the addition of urea and detergent. Gel filtration can be acceptable but often results in protein losses. Precipitation/resuspension is an effective means for removing salts and other contaminants, but can also result in protein losses (see section 1.4).
Endogenous small ionic molecules (nucleotides, metabolites, phospholipids, etc).	Endogenous small ionic molecules are present in any cell lysate. These substances are often negatively charged and can result in poor focusing toward the anode.	TCA/acetone precipitation is particularly effective at removing this sort of contaminant. Other desalting techniques may be applied (see above).
Albumin and IgG in human serum	These two major protein components of serum represent greater than 60% of the total protein in human serum content. During gel analysis of serum, the high concentration of albumin and IgG often masks the presence of other proteins with similar isoelectric point and/or molecular weight. Therefore, removal of albumin and IgG from serum samples, prior to electrophoresis, improves the resolution of lower-abundance proteins in two ways: by enabling visualization of proteins that co-migrate with albumin and IgG; and by removal of a large portion of the total serum protein, which allows an increase in the protein load of the low-abundant proteins.	Affinity resins selectively remove these contaminants from human serum.

continues on following page

Table 11. Contaminants that affect 2-D results (continued).

Contaminant	Reason for removal	Removal techniques
Ionic detergent	Ionic detergent (usually SDS) is often used during protein extraction and solubilization, but can strongly interfere with IEF. SDS forms complexes with proteins, and the resulting negatively charged complex will not focus unless the SDS is removed or sequestered.	Dilute the SDS-containing sample into a rehydration solution containing a zwitterionic or nonionic detergent (CHAPS, Triton X-100, or Nonidet™ P-40 [NP-40]) so the final concentration of SDS is 0.25% or lower and of SDS is 0.25% or lower and the ratio of the other detergent to SDS is at least 8:1 (27). Acetone precipitation of the protein will partially remove SDS. Precipitation at room temperature will maximize removal of SDS, but protein precipitation is more complete at -20 °C (45).
Nucleic acids (DNA, RNA)	Nucleic acids increase sample viscosity and cause background smears. High-molecular-weight nucleic acids can clog gel pores. Nucleic acids can bind to proteins through electrostatic interactions, preventing focusing. If the separated sample proteins are visualized by silver staining, nucleic acids present in the gel will also stain, resulting in a background smear on the 2-D gel.	Treat samples rich in nucleic acids with a protease-free DNase/RNase mixture to reduce the nucleic acids to mono- and oligonucleotides. This is often done by adding 0.1 times the volume of a solution containing 1 mg/ml DNase I, 0.25 mg/ml RNase A, and 50 mM MgCl ₂ followed by incubation on ice (33, 50). Note: The DNase and RNase proteins may appear on the 2-D map. Ultracentrifugation can be used to remove large nucleic acids; however, this technique may also remove high-molecular-weight proteins from the sample. When using low ionic strength extraction conditions, negatively charged nucleic acids may form complexes with positively charged proteins. High ionic strength extraction and/or high-pH extraction may minimize these interactions. (Note that salts added during extraction must be subsequently removed; see above.)
Polysaccharides	Polysaccharides can clog gel pores causing either precipitation or extended focusing times, resulting in horizontal streaking. Some polysaccharides contain negative charges and can complex with proteins by electrostatic interactions.	Precipitate the sample in TCA, ammonium sulfate, or phenol/ammonium acetate, then centrifuge. Ultracentrifugation will remove high-molecular-weight polysaccharides. Employing the same methods used for preventing protein-nucleic acid interactions may also be helpful (solubilize sample in SDS or at high pH).
Lipids	Many proteins, particularly membrane proteins, are complexed with lipids. This reduces their solubility and can affect both the pI and the molecular weight. Lipids form complexes with detergents, reducing the effectiveness of the detergent as a protein-solubilizing agent. When extracts of lipid-rich tissues are centrifuged, there is often a lipid layer that can be difficult to remove.	Strongly denaturing conditions and detergents minimize protein-lipid interactions. Excess detergent may be necessary. Precipitation with acetone removes some lipid.
Phenolic compounds	Phenolic compounds are present in many plant tissues and can modify proteins through an enzyme-catalyzed oxidative reaction (43, 49).	Prevent phenolic oxidation by employing reductants during tissue extraction (e.g. DTT, 2-mercaptoethanol, sulfite, ascorbate). Rapidly separate proteins from phenolic compounds by precipitation techniques. Inactivate polyphenol oxidase with inhibitors such as diethyldithiocarbamic acid or thiourea. Remove phenolic compounds by adsorption to polyvinylpyrrolidone (PVP) or polyvinylpyrrolidone (PVPP).

continues on following page

Table 11. Contaminants that affect 2-D results (continued).

Contaminant	Reason for removal	Removal techniques
Insoluble material	Insoluble material in the sample can clog gel pores and result in poor focusing. Insoluble material is particularly problematic when the sample is applied using sample cups as it can prevent protein entry into the IPG strip.	Samples should always be clarified by centrifugation prior to application in first-dimension IEF.

Even relatively low concentrations of salts (< 5 mM) can slow down separation, prevent sharp focusing, or cause disturbances that result in a poor-quality 2-D result. Low-molecular-weight ionic impurities can originate either as endogenous components of the sample source or as salts and buffers introduced during preparation of the sample. In either case, the ability of a sample to be effectively separated by first-dimension IEF, and the subsequent quality of the 2-D electrophoresis result can often be improved by dialyzing the sample prior to application. Mini Dialysis Kit is well suited for this application because the capacity of the dialysis tubes (10–250 μ l or 200–2000 μ l) corresponds to typical volume ranges for 2-D samples and because sample losses from the procedure are negligible.

1.5.1 Desalting samples using Mini Dialysis Kit

Mini Dialysis Kit is designed for the dialysis of small sample volumes with minimal handling and sample loss, offering a simple solution to the handling problems of low-volume dialysis and reducing the pronounced streaking on 2-D gels caused by low-molecular-weight contaminants (Fig 10). The kit contains dialysis tubes, each of which consists of a sample tube with a cap that is fitted with a dialysis membrane. Sample is easily and quantitatively transferred into and out of the tube by pipetting.

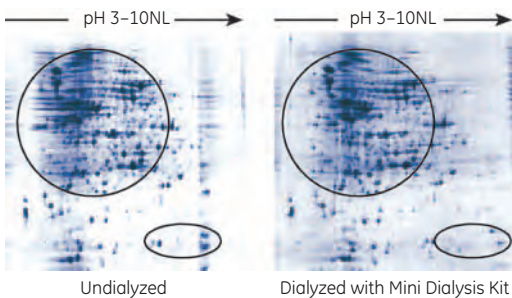

Fig 10. Effect of dialysis on 2-D resolution. Sample: *E. coli* protein extracted with 15 mM NaCl, 8 M urea, 0.5% Pharmalyte pH 3–10, 2% CHAPS. Dialysis: Mini Dialysis Kit 8 kDa, 250 μ l, 17 h against 8 M urea. First dimension: Approximately 400 μ g *E. coli* protein, 13-cm Immobiline DryStrip pH 3–10 NL, Ettan IPGphor Isoelectric Focusing System 32 kVh. Second dimension: SDS-PAGE (12.5%), SE 600 vertical electrophoresis system (16 x 16 cm gel). Stain: Colloidal Coomassie™ G-250.

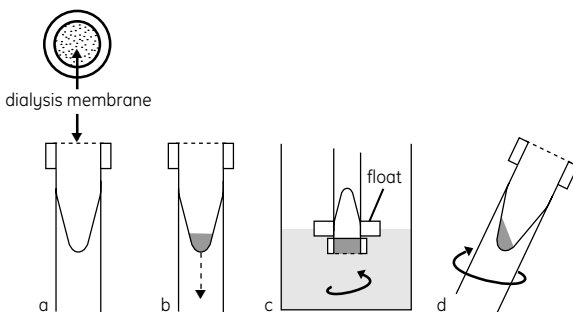

Fig 11. Schematic of the method used in Mini Dialysis Kit. (a) Cap with dialysis membrane, conical inner sample tube. (b) Introduce sample, screw on cap, and slide tube into float. (c) Invert and dialyze while stirring. (d) Spin briefly to collect sample.

The capped tube is inverted in a stirred beaker containing the solution against which the sample is to be dialyzed. Salts and molecules smaller than the molecular weight cut-off of the dialysis membrane are effectively exchanged through the membrane. Following dialysis, the tube is centrifuged briefly. This forces the entire contents of the dialysis tube into the bottom of the tube, ensuring essentially 100% recovery. The dialyzing cap is replaced with a normal

cap for storage of the dialyzed sample (Fig 11). The kit is available with a choice of molecular weight cut-off (either 1 kDa or 8 kDa) and a choice of tubes for sample volumes of either 250 μ l or 2 ml. Each kit contains dialysis tubes and associated accessories sufficient for preparing 50 samples.

Dialysis times of a few hours to overnight are sufficient to reduce ionic contaminants to a level that does not interfere with first-dimension IEF separation.

Since some detergents, notably Triton X-100 and SDS, form high-molecular-weight micelles at low concentration, they cannot be effectively removed by dialysis. Other techniques, such as sample precipitation with 2-D Clean-Up Kit (see section 1.4.1), must be used to remove these detergents.

Protocol: Mini Dialysis Kit

Components supplied

Dialysis tubes with caps incorporating a dialysis membrane (tubes for up to 250 μ l or 2 ml sample are included in the kit), caps (standard tube caps to seal the tubes following dialysis), floats (floating plastic sponges to suspend the inverted dialysis tubes in the dialysis solution).

Required but not provided

Centrifuge (dependent on size of dialysis tube) capable of low speeds.

Preliminary notes

Prior to dialysis, samples for native IEF should be solubilized in water while samples for denaturing IEF for 2-D work should be solubilized in a solution containing urea, reductant, and nonionic detergent. See sections 1.6.1 and 1.6.2 for details.



Handle dialysis tubes and caps with gloves.



Dialysis tubes are supplied in 0.05% (w/v) sodium azide and require rinsing before use.

1. Rinse dialysis tube and cap with distilled or deionized water (Fig 11A).
Keep cap covered with water until needed.
Do not allow cap with dialysis membrane to dry out.
2. Remove cap from water. Remove excess water with a micropipette. Ensure that the cap is tightly sealed.
3. Add sample to dialysis tube and replace dialysis cap (Fig 11B). For 250 μ l dialysis tubes, use 10–250 μ l of sample. For 2-ml dialysis tubes, use 200 μ l–2 ml of sample.
4. Invert dialysis tube ensuring that entire sample rests on dialysis membrane.
If the sample is viscous and does not initially rest on the membrane, the dialysis tube can be centrifuged in the inverted position at 10–100 \times g for no more than 6 s.



Spinning longer or faster may rupture the membrane.

5. Secure dialysis tube to one of the floats provided. Place dialysis tube and float assembly (cap-end down) in a beaker of the solution to be dialyzed against (e.g. water or 1% glycine for native IEF or sample buffer containing urea, reducing agent, and nonionic detergent for denaturing IEF; see sections 1.6.1 and 1.6.2 for details). Check that the dialysis membrane fully contacts the dialysis solution and that no large air bubbles are trapped beneath the dialysis membrane. Remove any air bubbles by tilting the tube or squirting dialysis solution onto the membrane.



See section below on dialysis solutions.

6. Dialyze while stirring (Fig 11C). During dialysis, invert dialysis tube to thoroughly mix contents.
Note: Optimal dialysis time depends on several factors, including the nature and volume of the sample, the molecular weight cut-off of the dialysis membrane and the temperature. Normally, dialysis for 2 h to overnight is sufficient to reduce ionic contaminants to a level that does not interfere with IEF separation. Dialysis may be carried out at 4–8 $^{\circ}$ C to minimize sample degradation or modification, but this will slow down the dialysis. Dialysis can be conducted at room temperature if degradation or modification is not a concern.
7. After dialysis, centrifuge dialysis tube for 6 s at 500–1000 \times g to collect sample (Fig 11D).
8. Remove dialysis cap and replace with normal cap for storage.
The protein concentration of the sample is best determined using the 2-D Quant Kit. The kit allows accurate quantitation of protein in the presence of detergents, reductants, and chaotropes that are incompatible with other assays. See section 1.7.1 for a protocol describing the use of 2-D Quant Kit.

Dialysis solution

A substantial reduction in interfering ions can be achieved by dialyzing 2-D samples against a solution volume at least 40 times the sample volume, for 2 h to overnight.

Dialyze the sample against a solution that has the same concentrations of chaotropes (urea and thiourea) and DTT as the sample. Other more expensive solution components such as CHAPS and carrier ampholytes do not need to be included in the dialysis solution. These components may be added to their required concentrations following dialysis.

Samples for 2-D electrophoresis should be prepared in a solution that will be compatible with first-dimension IEF, including urea, CHAPS, and DTT. See section 1.6.1 for details.

Vivaspin

Vivaspin concentrators can also be used for desalting samples

1.5.2 Removing undesirable nucleic acids from samples using Nuclease Mix

Removal of nucleic acids is often required to avoid contamination and subsequent artifacts on 2-D gels. Nuclease Mix offers an effective cocktail of bovine pancreatic DNase and RNase enzymes, together with the necessary cofactors for optimal nuclease activity. Nuclease Mix can be used together with Protease Inhibitor Mix since the latter does not contain EDTA, an inhibitor of nuclease activity.

Protocol: Nuclease Mix

Components supplied

Nuclease Mix (100× solution), 0.5 ml. Each Nuclease Mix contains 4 µg of DNase (bovine pancreas) and 1 µg of RNase (bovine pancreas) per µl solution.

Required but not provided

Vortex mixer.

1. Vortex briefly before taking an aliquot, as Nuclease Mix is supplied as a suspension.
2. Add 10 µl of Nuclease Mix per 1 ml reaction mix. Vortex briefly and incubate at room temperature for 30–45 min.

1.5.3 Simultaneous DNA, RNA and protein isolation from undivided scarce samples

The illustra triplePrep Kit is designed for the rapid extraction of genomic DNA, total RNA and total denatured protein from a single undivided sample. This kit can be used for removing undesirable nucleic acids. For more information on protocol, see product booklet, 28-9425-44.

1.5.4 Using Albumin and IgG Removal Kit to improve 2-D electrophoresis of human serum

Proteins in serum and other biological fluids are difficult to resolve by 2-D electrophoresis, largely due to the abundance of serum albumin and IgG. In human serum, albumin constitutes 50–70% of the total protein and IgG constitutes 10–25%. The presence of these proteins obscures other proteins in the gel and limits the amounts of proteins in the serum that can be resolved by 2-D electrophoresis. In addition, these proteins have wide pI and molecular weight ranges that further reduce resolution and mask some low-abundance proteins.

Albumin and IgG Removal Kit improves resolution of low-abundance proteins and increases the number of spots in the treated sample. The kit includes an affinity gel that selectively binds human albumin and IgG and enhances the visibility of low-abundance proteins. Albumin and IgG Removal Kit improves on the currently available Cibacron Blue dye-based technology, which lacks selectivity and can remove low-abundance proteins of interest. See Figures 12 and 13 for typical results. Figure 14 depicts the methodology used in the kit.

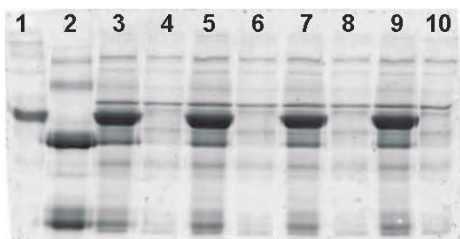

Lane 1: Human Serum Albumin
 Lane 2: Human IgG
 Lane 3: Untreated serum
 Lane 4: Treated serum replicate 1
 Lane 5: Untreated serum
 Lane 6: Treated serum replicate 2
 Lane 7: Untreated serum
 Lane 8: Treated serum replicate 3
 Lane 9: Untreated serum
 Lane 10: Treated serum replicate 4

Fig 12. Typical results when using the Albumin and IgG Removal Kit. Four replicates of a human serum sample were treated with Albumin and IgG Removal Kit using the standard protocol (untreated samples in lanes 3, 5, 7, and 9, and treated samples in lanes 4, 6, 8, and 10). Untreated human serum was diluted to an equivalent volume. Equivalent amounts of untreated and treated serum were separated onto a 12% acrylamide gel alongside purified albumin and IgG. The gel was stained with Sypro™ Ruby and imaged on Typhoon™ 9400 Variable Mode Imager.

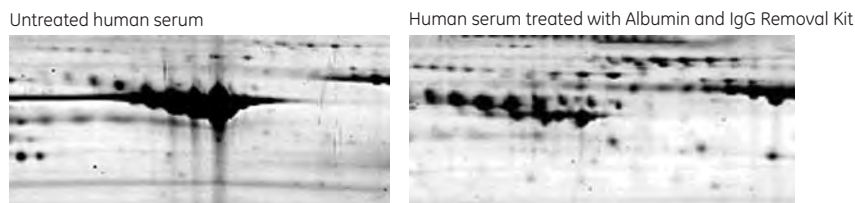

Fig 13. Removal of albumin from human serum. Following treatment with Albumin and IgG Removal Kit, albumin is removed and lower-abundance proteins gain increased resolution. The albumin region of the gel before and after treatment is shown above.

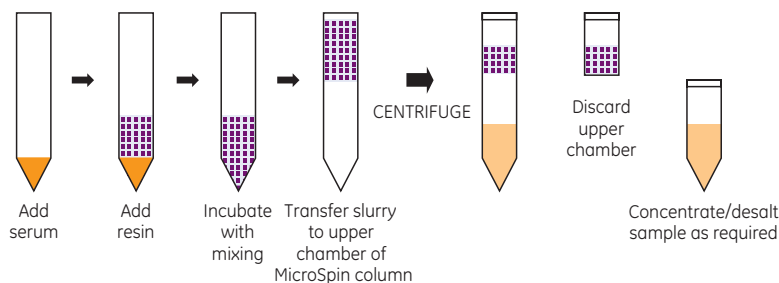

Fig. 14. Schematic of the removal process. Optimal albumin and IgG binding (>95% total protein) is achieved using a 15 µl human serum loading and will typically lead to recovery of between 150 and 220 µg of lower-abundance proteins. The amount of protein recovered will vary with the protein content of the individual serum samples used.

Protocol: Albumin and IgG Removal Kit

Components supplied

8.5 ml of a 50/50 (v/v) resin slurry, 10 empty microspin columns, 10 microcentrifuge tubes and lids.



Some of the components contain sodium azide in dilute solution. This substance is classified as toxic when undiluted. Follow all local safety regulations when disposing of waste. Unless local regulations dictate other methods, dispose of waste by flushing with copious amounts of water to avoid the build-up of explosive metallic azides in copper and lead plumbing.

Required but not provided



Microcentrifuge, rotary shaker, disposable 15-ml centrifuge tube.

If performing acetone precipitation for concentration/desalting, acetone and acetone-resistant microcentrifuge tubes are also required. Acetone precipitation is not necessary if using the 2-D Clean-Up Kit.

Preliminary notes



Ensure that the resin is in suspension when removing resin aliquots. Vigorous swirling of the resin bottle, before the removal of each aliquot is recommended, to ensure the resin remains in suspension. Remove an aliquot quickly using a wide-mouthed pipette tip.

-  During serum/resin incubation, ensure that the resin is kept in suspension by adequate mixing on a rotary shaker.
-  Ensure that centrifugation is performed at the correct g force, and for the required time. This allows all the liquid to be eluted from the resin following sample treatment. The resin should appear dry following centrifugation.
-  Use of the 2-D Clean-Up Kit makes acetone precipitation unnecessary. However, if performing an acetone precipitation, do not over-dry acetone-precipitated protein pellets.

Guidelines for serum sample loading with the Albumin IgG Removal Kit are listed in Table 12. The values are those seen when a typical human serum sample is treated using the Albumin and IgG Removal Kit. Human serum samples contain widely varying levels of albumin and IgG, and the information below should be used for guidance only.

Table 12. Typical levels for removal of albumin and IgG.

Human serum sample volume	Typical level of albumin removed	Typical level of IgG removed
15 µl	> 95%	> 90%
30 µl	> 80%	> 80%
45 µl	> 60–70%	> 70%

1. Pipette 15 µl of human serum into a sample tube with lid.

 Tubes to be used for sample incubation should be of adequate size to allow good mixing of the resin/serum sample volume, to ensure the resin remains in suspension during the incubation period. Disposable 15-ml centrifuge tubes are recommended.

2. Add 750 µl of the suspended slurry to the tube containing the sample. It is essential that the gel slurry is homogenous (uniform suspension) prior to pipetting.

 When dispensing the resin it may be easier to pipette if the narrow end of the tip is cut off. This would normally be performed with scissors prior to use.

3. Mix the gel/sample mixture on a rotary shaker for a minimum of 30 min at room temperature. Mixing speed should be sufficient to keep the gel/sample in suspension.

 Rapid rotary shaking is required to ensure that the resin remains in suspension. Speeds in the region of 250 rpm are recommended.

4. Snap off the base tip of the microspin column. Place each column into a microcentrifuge tube (supplied).

5. At the end of the incubation period, make sure that the resin is in suspension, and carefully pipette the gel/sample mixture into the upper chamber of the microspin column, which is sitting in a microcentrifuge tube.

 Ensure that all liquid is removed from the tube. If drops of liquid are splashed around the incubation tube, briefly centrifuge the incubation tube and contents (1000 rpm, 2 min) to collect the resin and liquid, prior to transfer to the microspin column.

6. Centrifuge at approximately 6500 × g for 5 min.

Note: The resin should appear dry and powdery following centrifugation.

7. Discard the upper chamber containing the gel, and collect the filtrate.

Note: The approximate volume of the filtrate will be 500 µl.

8. The sample is now ready to be used immediately for further processing or stored for later use.

 If proteins are to be analyzed by 2-D gel analysis, concentration and desalting will be required.

Protocol for acetone precipitation (not required if using 2-D Clean-Up Kit)

1. Place an aliquot of acetone at -20 °C at least 15 min prior to use.

 Approximately 2 ml of acetone is required for each sample. Ensure that the tube is made of an acetone-compatible material.

2. Accurately measure the volume of each sample. Divide each sample volume into two microcentrifuge tubes. Add 4 volumes of ice cold acetone to the sample volume in each tube.



1.5-ml hinged microcentrifuge tubes are recommended. Small pellets are easily visualized using this type of tube.

3. Allow proteins to precipitate at $-20\text{ }^{\circ}\text{C}$ for at least 2 h.
4. Pellet proteins by centrifugation at approximately $13\ 000 \times g$ ($13\ 000\ \text{rpm}$ in a small bench microcentrifuge) for 10 min at $2\text{--}8\text{ }^{\circ}\text{C}$.



Place the tubes into the microcentrifuge in known orientation. Place the hinged lid outward, as this assists with detection of small protein pellets.

5. Decant off the acetone, but do not disturb the pellet. A clean tissue can be used to carefully remove any spots of acetone away from the pellet.
6. Allow pellets to air dry (typically 5–10 min at room temperature). Do not over-dry.



Over-dried pellets can be difficult to resuspend.

7. Resuspend precipitated samples in an appropriate buffer as required.
Note: Typical levels of protein recovered from a $15\ \mu\text{l}$ serum sample are $150\text{--}220\ \mu\text{g}$.
8. If samples are not to be used immediately, store at $-20\text{ }^{\circ}\text{C}$ or $-70\text{ }^{\circ}\text{C}$ until required.

1.6 Composition of sample preparation solution

In order to achieve a well-focused first-dimension separation, sample proteins must be completely disaggregated and fully solubilized. Regardless of whether the sample is a relatively crude lysate or additional sample precipitation steps have been employed, the sample solution must contain certain components to ensure complete solubilization and denaturation prior to first-dimension IEF. These always include urea and one or more detergents. Complete denaturation ensures that each protein is present in only one configuration and that aggregation and inter-molecular interaction is avoided.

1.6.1 Components of sample preparation solutions

The role of each component of the sample solution is described below, as well as the recommended concentration range.

Denaturant

IEF performed under denaturing conditions gives the highest resolution and the cleanest results. Urea, a neutral chaotrope, is used as the denaturant in the first dimension of 2-D electrophoresis and is always included in the 2-D sample solution at a concentration of at least 8 M. Urea solubilizes and unfolds most proteins to their fully random conformation, with all ionizable groups exposed to solution. Recently, the use of thiourea in addition to urea has been found to further improve solubilization, particularly of membrane proteins (10, 16, 55–57).

Detergent

A nonionic or zwitterionic detergent is always included in the sample solution to ensure complete sample solubilization and to prevent aggregation through hydrophobic interactions. Originally, either of two similar nonionic detergents, NP-40 or Triton X-100, was used (1, 2). Subsequent studies have demonstrated that the zwitterionic detergent CHAPS (2–4%) is often more effective (58) for solubilizing a wide range of samples. New zwitterionic detergents have been developed and are reported to improve the solubility of membrane proteins (59, 60).

When difficulties in achieving full sample solubilization are encountered, the anionic detergent SDS can be used as a solubilizing agent. SDS is a very effective protein solubilizer, but because it is charged and forms complexes with proteins, it cannot be used as the sole detergent for solubilizing samples for 2-D electrophoresis. A widely used method for negating the interfering effect of SDS is dilution of the sample with a solution containing an excess of CHAPS, Triton X-100, or NP-40. The final concentration of SDS should be 0.25% or lower and the ratio of the excess detergent to SDS should be at least 8:1 (27, 34, 61).

Reductant

Reducing agents are frequently included in the sample preparation solution to break any disulfide bonds present and to maintain all proteins in their fully reduced state. The most commonly used reductant is dithiothreitol (DTT) at concentrations ranging from 20 to 100 mM. Dithio-erythreitol (DTE) is similar to DTT and can also be used as a reducing agent. Originally, 2-mercaptoethanol was used as a reductant, but higher concentrations of this reductant are required and inherent impurities may result in artifacts (62). More recently, the non-thiol reductant tributyl phosphine (TBP), at a concentration of 2 mM, has been used as a reductant for 2-D samples (63). However, due to the limited solubility and instability of TBP in solution, a thiol reductant such as DTT must also be added to maintain proteins in their reduced state through rehydration and first-dimension IEF. Reductants should be added directly before use.

Use of DeStreak Reagent is recommended for basic proteins. See section 2.6.2 for details.

Solubilizing agent

Carrier ampholytes or IPG Buffer (up to 2% [v/v]) can be included in the sample solution. They enhance protein solubility by minimizing protein aggregation due to charge-charge interactions. In some cases, buffers or bases (e.g. 40 mM Tris) are added to the sample solution. This is done when basic conditions are required for full solubilization or to minimize proteolysis. However, introduction of such ionic compounds can result in first-dimension disturbances. Bases or buffers should be diluted to 5 mM or lower prior to loading the sample onto first-dimension IEF.

1.6.2 Examples of sample preparation solutions

A widely used sample solution, which can be used for initial experiments with an unknown sample, is described in appendix I, solution A. To solubilize more hydrophobic proteins, use solution B in appendix I. For a general review of protein solubilization for electrophoretic analysis, see reference 9.

1.7 Quantitating protein samples

Electrophoresis of protein samples requires accurate quantitation of the sample to be analyzed to ensure that an appropriate amount of protein is loaded. In addition, accurate quantitation facilitates comparison between similar samples by allowing identical amounts of protein to be loaded. Accurate quantitation of samples prepared for electrophoresis is, however, difficult because many of the reagents used to prepare and solubilize samples for electrophoresis, including detergents, reductants, chaotropes, and carrier ampholytes, are incompatible with common protein assays.

Current spectrophotometric methods for protein quantitation rely either on Coomassie brilliant blue binding (65) or protein-catalyzed reduction of cupric (Cu^{2+}) ion to cuprous (Cu^+) ion (66–68). Dye-binding assays cannot be used in the presence of any reagent that also binds Coomassie brilliant blue. This includes carrier ampholytes such as Pharmalyte and IPG Buffer and detergents such as CHAPS, SDS, or Triton X-100. Assays that depend on the reduction of cupric ions cannot be used in the presence of reductants such as DTT, or in the presence of reagents that form complexes with cupric ions such as thiourea or EDTA.

Samples prepared for IEF and SDS gel electrophoresis are often difficult to quantitate due to the presence of detergent and reductant. Samples for 2-D electrophoresis are particularly difficult to quantitate due to the possible presence of interfering carrier ampholyte and thiourea in addition to the detergents and reductants typically used in sample preparation.

2-D Quant Kit (designed for the accurate determination of protein concentration in samples to be analyzed by high-resolution electrophoresis) circumvents these limitations and can be used to accurately quantitate protein samples prepared for 2-D electrophoresis. The procedure uses a combination of a unique precipitant and co-precipitant to quantitatively precipitate sample protein while leaving interfering contaminants in solution. The protein is pelleted by centrifugation and resuspended in an alkaline solution of cupric ions. The cupric ions bind to the polypeptide backbones of any protein present. A colorimetric agent that reacts with unbound cupric ions is then added. The color density is inversely related to the concentration of protein in the sample and the protein concentration can be accurately estimated by comparison to a standard curve. Since the assay does not depend on reaction with protein side-groups, reactivity is largely independent of amino acid composition. There is little protein-to-protein variation using this assay.

1.7.1 Protein determination using 2-D Quant Kit

2-D Quant Kit is designed to accurately determine protein concentrations in samples for electrophoresis. Proteins are quantitatively precipitated while interfering substances are left in solution. The color density that develops in the 2-D Quant Kit procedure is inversely related to the protein concentration, with a linear response to protein in the range of 0–50 μg and a volume range of 1–50 μl . The procedure is compatible with common sample preparation reagents listed in Table 13.

Table 13. Compounds tested for assay compatibility.

Compound	Concentration
SDS	2% (w/v)
CHAPS	4% (w/v)
Triton X-100	1% (w/v)
Pharmalyte pH 3–10	2% (v/v)
IPG Buffer pH 3–10 NL	2% (v/v)
Tris	50 mM
EDTA	10 mM
DTT	1% (65 mM)
2-mercaptoethanol	2% (v/v)
Urea	8 M
Thiourea	2 M
Glycerol	30% (w/v)

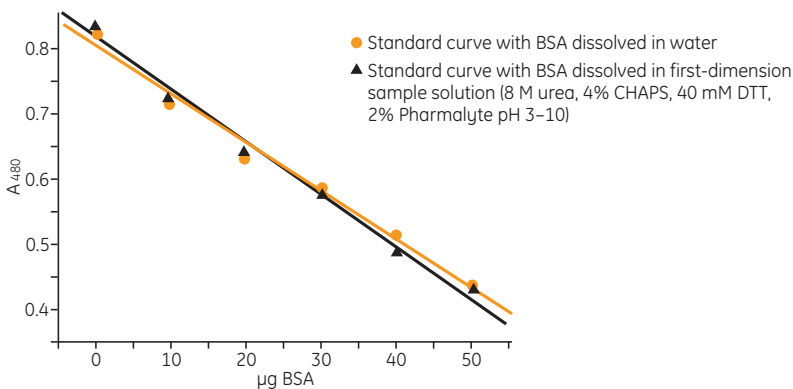

Fig 15. The 2-D Quant Kit protein assay eliminates interference from sample solution components.

Protocol: 2-D Quant Kit

Components supplied

Precipitant, co-precipitant, copper solution, color reagent A, color reagent B, bovine serum albumin (BSA) standard solution.



Required but not provided

Microcentrifuge, microcentrifuge tubes (2 ml), vortex mixer, visible-light spectrophotometer, spectrophotometer cells.

Preliminary notes

Prior to starting procedure, prepare working color reagent by mixing 100 parts of color reagent A with one part of color reagent B. Each individual assay requires 1 ml working color reagent.

1. Prepare standard curve (0–50 μg) using the 2 mg/ml BSA standard solution.
2. Prepare microcentrifuge tubes (in duplicate) containing 1–50 μl of the sample to be assayed. The useful range of the assay is 0.5–50 μg .

3. Add 500 μl precipitant to each microcentrifuge tube (including tubes containing the BSA standard). Vortex and incubate 2–3 min at room temperature.
4. Add 500 μl co-precipitant. Mix briefly.
5. Centrifuge (at least 10 000 \times g) for 5 min.
6. Remove supernatant. Centrifuge briefly to bring remaining supernatant to bottom of tube. Remove remaining supernatant with micropipette.
 Proceed rapidly to avoid resuspension or dispersion of pellet. There should be no visible liquid remaining.
7. Add 100 μl copper solution and 400 μl distilled or deionized water to each tube. Vortex to dissolve the precipitated protein.
 Ensure that the pellet is completely resuspended by vortexing thoroughly.
8. Add 1 ml working color reagent to each tube. Ensure instantaneous mixing by introducing the reagent as rapidly as possible.
9. Incubate at room temperature for 15–20 min.
10. Read the absorbance at 480 nm for each sample and standard using a spectrophotometer such as Ultrospec1100 pro UV/Visible Spectrophotometer.
11. Generate standard curve by plotting the absorbance of the standards against the quantity of protein.
12. Estimate protein concentration of samples by comparison to the standard curve.

1.8 Sample loads

The optimal quantity of protein to load for electrophoresis varies widely depending on factors such as sample complexity, the length and pH range of the Immobiline DryStrip gel, and the method of visualizing the 2-D separation. General sample load guidelines for different staining techniques are given in chapter 2, Table 16.

2. First-dimension isoelectric focusing (IEF)

2.0 Overview

GE Healthcare offers two flatbed electrophoresis systems for first-dimension separation using isoelectric focusing (IEF): Ettan IPGphor 3 Isoelectric Focusing System and Multiphor II Electrophoresis System. This chapter provides information on Ettan IPGphor 3; information specific to Multiphor II is covered in chapter 4.

Ettan IPGphor 3 Isoelectric Focusing System comprises Immobiline DryStrip gel strips, which contain an immobilized pH gradient (IPG) and are commonly referred to as IPG strips; two accessory options for holding the strips in place— the Manifold and fixed-length Strip Holders; and the Ettan IPGphor 3 unit, which includes a high-voltage DC power supply, solid state temperature control using Peltier technology, and programming options for up to 10 user-defined IEF protocols.

IPG strips are available in five lengths—7, 11, 13, 18, and 24 cm—and a number of pH ranges, both linear and nonlinear. Section 2.2 discusses choices for length of strip, pH gradient, and buffer.

The Manifold accommodates IPG strips from 7 to 24 cm long, and holds up to 12 strips. It allows for three main means of sample application:

- (1) rehydration loading, generally for preparative or analytical loadings of broad-range or narrow-range strips;
- (2) cup loading (anodic or cathodic), generally for analytical loadings of basic strips or very acidic strips, respectively; and
- (3) paper-bridge loading (anodic or cathodic), generally for preparative loadings of basic strips or very acidic strips, respectively.

Further discussion of these techniques can be found in section 2.7.

The Manifold must be used in conjunction with the DryStrip IPGbox (with or without sample included) in order to rehydrate the Immobiline DryStrips (see section 2.7). The Manifold can also be used for equilibrating the IPG strips prior to second-dimension electrophoresis.

The regular Strip Holder (see section 2.7) is placed on the Ettan IPGphor 3 electrode platform, and the sample is introduced either during or after the rehydration step. Up to 12 Strip Holders of the same length can be accommodated for any one protocol.

An earlier product, the Cup Loading Strip Holder, is not included in the discussion that follows.

2.1 Background to isoelectric focusing

Isoelectric Focusing is an electrophoretic method that separates proteins according to their isoelectric points (pI). Proteins are amphoteric molecules; they carry either positive, negative, or zero net charge, depending on the pH of their surroundings (Fig 16). The net charge of a protein is the sum of all the negative and positive charges of its amino acid side chains and amino- and carboxyl-termini. The isoelectric point (pI) is the specific pH at which the net charge of the protein is zero. Proteins are positively charged at pH values below their pI and negatively charged at pH values above their pI. If the net charge of a protein is plotted versus the pH of its environment, the resulting curve intersects the x-axis at the isoelectric point (Fig 16).

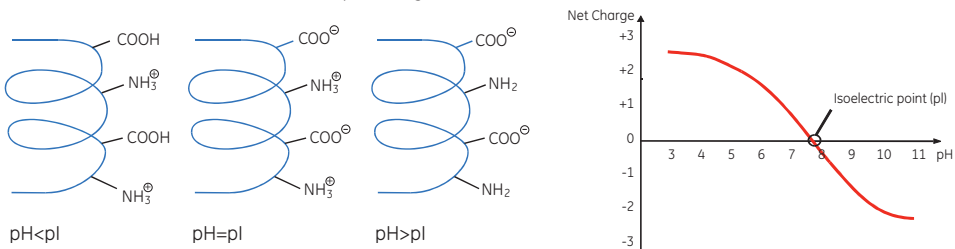

Fig 16. Plot of the net charge of a protein versus the pH of its environment. The point of intersection of the curve at the x-axis represents the isoelectric point of the protein.

The presence of a pH gradient is critical to the IEF technique. In a pH gradient and under the influence of an electric field, a protein will move to the position in the gradient where its net charge is zero. A protein with a net positive charge will migrate toward the cathode, becoming progressively less positively charged as it moves through the pH gradient until it reaches its pI. A protein with a net negative charge will migrate toward the anode, becoming less negatively charged until it also reaches zero net charge. If a protein should diffuse away from its pI, it immediately gains charge and migrates back. This is the focusing effect of IEF, which concentrates proteins at their pIs and allows proteins to be separated on the basis of very small charge differences.

The resolution is determined by the slope of the pH gradient and the electric field strength. IEF is therefore performed at high voltages (typically in excess of 1000 V). When the proteins have reached their final positions in the pH gradient, there is very little ionic movement in the system, resulting in a very low final current (typically in the microamp range). IEF of a given sample in a given electrophoresis system is generally performed for a constant number of Volt-hours (Volt-hour [Vh] being the integral of the volts applied over the separation time).

IEF performed under denaturing conditions gives the highest resolution and the sharpest results. Complete denaturation and solubilization is achieved with a mixture of urea, detergent, and reductant, ensuring that each protein is present in only one conformation with no aggregation, therefore minimizing intermolecular interactions. See section 1.6 for a discussion of the components of sample preparation solutions.

The original method for first-dimension IEF depended on carrier-ampholyte-generated pH gradients in cylindrical polyacrylamide gels cast in glass rods or tubes (1). Carrier ampholytes are small, soluble, amphoteric molecules with a high buffering capacity near their pI. When a voltage is applied across a carrier ampholyte mixture, the carrier ampholytes with the highest pI (and the most negative charge) move toward the anode; those with the lowest pI (and the most positive charge) move toward the cathode. The other carrier ampholytes align themselves between the extremes according to their pIs, and buffer their environment to the corresponding pHs. The result is a continuous pH gradient.

As a result of limitations and problems associated with carrier ampholyte pH gradients, immobilized pH gradients (IPG) were developed. GE Healthcare subsequently introduced Immobiline chemicals for the generation of this type of pH gradient (2). Görg *et al.* (3, 4) pioneered the development and use of IPG IEF for the first-dimension of 2-D electrophoresis.

An immobilized pH gradient is created by covalently incorporating a gradient of acidic and basic buffering groups (immobilines) into a polyacrylamide gel at the time it is cast. Immobiline buffers are a set of well-characterized molecules, each with a single acidic or basic buffering group linked to an acrylamide monomer.

The general structure of Immobiline reagents is:

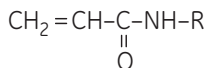

R = weakly acidic or basic buffering group

Immobilized pH gradients are formed using two solutions, one containing a relatively acidic mixture of acrylamido buffers and the other containing a relatively basic buffer mixture. The concentrations of the various buffers in the two solutions define the range and shape of the pH gradient produced. Both solutions contain acrylamide monomers and catalysts. During polymerization, the acrylamide portion of the buffers copolymerizes with the acrylamide and bisacrylamide monomers to form a polyacrylamide gel. Figure 17 is a graphic representation of the polyacrylamide matrix with attached buffering groups.

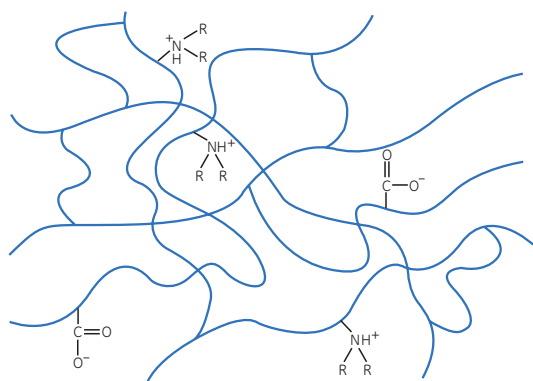

Fig 17. Immobilized pH gradient polyacrylamide gel matrix showing attached buffering groups.

For improved performance and simplified handling, the Immobiline DryStrip gel is cast onto a plastic backing (GelBond™ PAGfilm). The gel is then washed to remove catalysts and unpolymerized monomers that could otherwise modify proteins and interfere with separation. Finally, the gel is dried and cut into 3-mm-wide strips. The resulting Immobiline DryStrip gels can be rehydrated with a rehydration solution containing the necessary components for first-dimension IEF.

IEF is performed with the Immobiline DryStrip gels using a flatbed electrophoresis unit such as Ettan IPGphor 3. The advantages of using the flatbed format are:

- Since the *pI* of a protein is dependent on the temperature, precise cooling is required during IEF. This can be effectively achieved by using the aluminum oxide ceramic Strip Holder or Manifold in conjunction with a Peltier temperature-controlled bed.
- Since IEF requires high field strengths to obtain sharply focused bands, high voltages must be applied. A flatbed design is the most economical way to meet the necessary safety standards required to operate at such high voltages.

2.2 Immobiline DryStrip gels

Immobiline DryStrip gels offer a marked improvement over tube gels using carrier ampholyte-generated pH gradients. When Immobiline DryStrip gels are used for the first-dimension separation, the resultant 2-D spot maps provide superior results in terms of resolution and reproducibility:

- The first-dimension separation is more reproducible because the covalently fixed gradient cannot drift.
- Plastic-backed Immobiline DryStrip gels are easy to handle. They can be picked up at either end with forceps or gloved fingers.
- The plastic support film prevents the gels from stretching or breaking.
- IPG technology increases the useful pH range on any single Immobiline DryStrip gel; more very acidic and basic proteins can be separated.
- Immobiline DryStrip gels have a higher protein loading capacity (69).
- The sample can be introduced into the Immobiline DryStrip gel during rehydration (70, 71).
- Precast Immobiline DryStrip gels eliminate the need to handle toxic acrylamide monomers. In addition, preparation time and effort are significantly reduced, and reproducibility of the pH gradient is ensured.

Additional advantages of Immobiline DryStrip gels include:

- Immobilized pH gradients and precise lengths ensure high reproducibility and reliable gel-to-gel comparisons.
- To simplify gel use and record keeping, each strip is labeled with the pH interval and a unique identifier, and bar-coded for use with a reader. A "+" or "-" sign indicates the anodic or cathodic side of the strip, respectively.

- Immobililine DryStrip gels are compatible with Ettan DIGE system, the most powerful approach for comparative analysis of relative protein abundance using 2-D electrophoresis (see chapter 6).

Figure 18 illustrates the pH intervals of Immobililine DryStrip gels. The most recent additions to the product line comprise two sets of pH interval: a broad-range gel (pH 3–11 NL) and four medium-range gels covering shorter pH intervals—pH 3–5.6 NL, 5.3–6.5, 6.2–7.5, and 7–11 NL. These four medium-range gradients overlap each other in an optimized way, allowing outstanding coverage of all proteins in the pH 3 to 11 range, with improved separation in the extreme basic pH region of the IPG strips. Narrow-range Immobililine DryStrip gels covering just one pH unit are a valuable complement to the newer strips in many experimental situations.

IPG Strips	Strip length				
	24 cm	18 cm	13 cm	11 cm	7 cm
Narrow					
3.5-4.5	x				
5.3-6.5	x	x	x	x	x
6.2-7.5	x	x	x	x	x
Medium					
3-5.6 NL	x	x	x	x	x
3-7 NL	x				
4-7	x	x	x	x	x
6-9	x	x			
6-11		x	x	x	x
7-11 NL	x	x	x	x	x
Wide					
3-10	x	x	x	x	x
3-11 NL	x	x	x	x	x
3-10 NL	x	x	x		x

Fig 18. A comprehensive range of overlapping IPG strips covering narrow, medium, and wide pH ranges are available in several different strip lengths.

DryStrip gels are rehydrated in a solution containing the necessary additives and, optionally, the sample proteins (rehydration solution is described in detail in section 2.6). IEF is performed at high voltage. After IEF, the Immobililine DryStrip gels are equilibrated in equilibration solution and applied onto vertical or flatbed SDS-polyacrylamide gels for the second-dimension separation (see chapter 3).



After IEF, proceed to the second-dimension separation immediately or store the Immobililine DryStrip gels at -60°C or below, as described in section 2.8.3.

2.2.1 Choosing strip length

Immobililine DryStrip gels are available with strip lengths of 7, 11, 13, 18, and 24 cm, with a precise gel length tolerance of ± 2 mm.

Choose shorter strips, i.e. up to 13 cm, for fast, cost-effective screening or when the most abundant proteins are of highest interest (as in pre-fractionated protein complexes). The shortest IPG strips give the fastest results, but their sample load is limited.





Use longer strips, i.e. 18- and 24-cm strips, for maximal resolution and loading capacity. Longer strips allow detection of more spots and make it easier to select and identify the proteins in the map, but require longer times in both the first- and the second-dimension separations. Table 14 shows the inter-relationship between these parameters. For the highest possible resolution, use 24-cm strip lengths.

Table 14. Typical operating parameters for Immobiline DryStrip pH 4–7 gels with *E. coli* extract and analytical load. The number of detectable spots is increased by roughly the same factor as the increase in separation length. The same relationship is true for other pH intervals as well.

Parameters	7 cm	11 cm	13 cm	18 cm	24 cm
Time first dimension (h)	2	4	4	6	10
Time second dimension (h)	1.5	2.5	3	5.5	5.5
Sample load (μg proteins) —analytical gels	10	25	30	55	90

2.2.2 Choosing the pH gradient

Immobiline DryStrip gels allow effective IEF over a wide pH range, from very acidic proteins at pH 3 to extremely basic proteins at pH 11. These varied pH intervals allow fine-tuning of each separation strategy to increase first-dimension loading and resolve a greater number of spots from crowded areas. Both aspects will improve later protein identification and characterization.

-  To overview total protein distribution, use pH 3–11 NL strips (NL refers to nonlinear). The broad-range pH 3–11 NL Immobiline DryStrip gel works with most protein mixtures from prokaryotic and eukaryotic cells. Results obtained can be used as a basis for developing a more specific separation strategy using medium-range pH gradients.
-  For increased resolution between pH 5 and pH 7, use a nonlinear gradient pH 3–10 strip (pH 3–10 NL) to distribute the proteins more evenly over the strip. This is especially helpful when analyzing complex samples like serum, cerebrospinal fluid, extracts from *E. coli*, and yeasts.
-  Combine pH 3–7 and pH 6–11, or pH 3–7 and pH 6–9, or select from pH 3–5.6 NL, 5.3–6.5, 6.2–7.5, or 7–11 NL when more detail is required. Of these, the two NL strips—pH 3–5.6 NL and 7–11 NL—are nonlinear at the extreme ends of the pH scale, allowing a more even distribution of proteins over the gel length and maximized resolution. The pH 3–5.6 NL, 5.3–6.5, 6.2–7.5, and 7–11 NL strips provide optimal overlaps, and approximately the same number of proteins is separated in each pH interval. Higher sample loading capacity of medium-range gels makes protein identification easier.
-  Use narrow-pH-range strips (1 pH unit) to closely study proteins in the regions of interest. Narrow gradients of 1 pH unit allow higher resolution, in-depth study of proteins separating in these regions, and increased loading capacity. Several milligrams of protein extract can be analyzed when using rehydration loading (including protein samples in the rehydration solution), which simplifies identification and characterization of spots in the 2-D map.

Note: To increase the stability of the pH gradient in Immobiline DryStrip pH 7–11 NL, during production the buffering capacity is enhanced at the most basic end by the introduction of a proprietary arginine derivative (guanidyl group). To avoid redox-related streaking, all the basic strips should be rehydrated with DeStreak Rehydration Solution (see sections 2.6.1 and 2.6.2).

Note: The gradients overlap to enable the assembly of virtual high-resolution 2-D maps from different narrow-range separations.

If a specialized pH gradient is required, recipes for preparing custom narrow- and wide-range immobilized pH gradients are given in references 72 and 73.

Figure 19 shows typical results using broad- and medium-range, 24-cm Immobiline DryStrip gels.

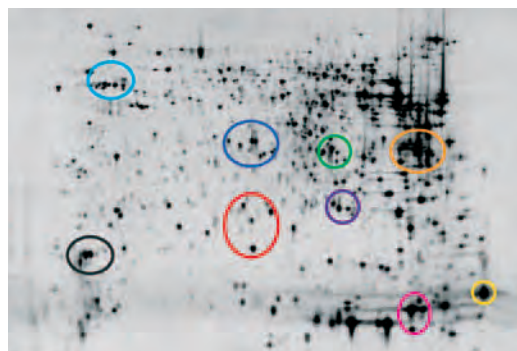

Fig 19a. Broad-range Immobiline DryStrip pH 3–11 NL, 24 cm using 0.5% IPG Buffer 3–11 NL, run for 42 kvh. Sample: 100 µg mouse liver extract + 7.5 µg alkylated lysozyme, cup application at the anode.



Fig 19b. Medium-range Immobiline DryStrip pH 3–5.6 NL, 24 cm using 2% IPG Buffer 3.5–5.0, run for 50 kvh. Sample: 140 µg mouse liver extract, cup application at the cathode.

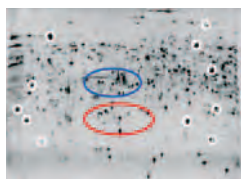

Fig 19c. Medium-range Immobiline DryStrip pH 5.3–6.5, 24 cm using 2% IPG Buffer 5.5–6.7, run for 116 kvh. Sample: 100 µg mouse liver extract, cup application at the anode.

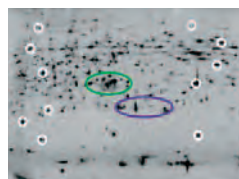

Fig 19d. Medium-range Immobiline DryStrip pH 6.2–7.5, 24 cm using 2% IPG Buffer 6–11, run for 116 kvh. Sample: 100 µg mouse liver extract, cup application at the anode.

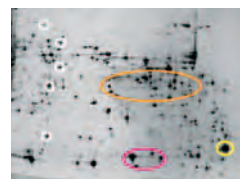

Fig 19e. Medium-range Immobiline DryStrip pH 7–11 NL, 24 cm using 0.5% IPG Buffer 7–11 NL, run for 75 kvh. Sample: 100 µg of mouse liver extract + 5 µg alkylated lysozyme, cup application at the anode.

Fig 19. Two-dimensional electrophoresis of mouse liver extract, with or without alkylated lysozyme, using broad- and medium range, 24-cm Immobiline DryStrip gels. All first-dimension results shown in Figure 19 were run on Ettan IPGphor 3 with Ettan IPGphor 3 Manifold. Immobiline DryStrip gels were rehydrated in DeStreak Rehydration Solution with IPG Buffer solutions as indicated. Second dimension: Ettan DALT twelve using DALT Gel 12.5 precast SDS-PAGE gels. Staining: PlusOne Silver Staining Kit, Protein. White rings = same protein seen on two pH intervals i.e. overlaps between pH gradients. Rings or ovals of the same color present on the broad pH gradient 3–11 NL (Fig 19a) and the medium-range gradients (Figs 19b–19e) indicate the same protein groups. Yellow ring = alkylated lysozyme, $pI = 10.5$ (calculated according to SwissProt).

2.2.3 Choosing an IPG Buffer

IPG Buffers are ampholyte-containing buffer concentrates specifically formulated for use with Immobiline DryStrip gels. Each IPG Buffer type produces more uniform conductivity along the Immobiline DryStrip during focusing, resulting in wider latitude in run times. IPG Buffers also eliminate potential high background staining. The buffers, supplied in 1-ml aliquots, are diluted 50- or 200-fold in the rehydration solution, depending on the first-dimension system and pH range of the strip. Figure 20 shows the appropriate IPG Buffer for use with the various IPG DryStrip gels.

2.2.4 Estimating the pI of proteins

The reliability of the first-dimension separation is so high that the pI of a protein can be estimated by relating its position on the second-dimension gel to its original position on the Immobiline DryStrip. Using linear pH gradients increases the accuracy of this estimation.

Determine the first-dimension position by measuring the length of the Immobiline DryStrip gel and the position of the spot on the second-dimension gel (for gels not attached to backing, correct for shrinkage or swelling of the gel during staining). Then plot the spot position (as a percent of gel length) versus pH and read off the pI from the graph of the pH gradient found in Data File 18-1177-60 (see additional reading and reference material).

IPG Buffers	pH range						
	3.5-5.0	5.5-6.7	4-7	6-11	7-11 NL	3-10 NL	3-11 NL
Narrow							
3.5-4.5	•						
5.3-6.5		•					
6.2-7.5				•			
Medium							
3-5.6 NL	•						
3-7 NL			•				
4-7			•				
6-9				•			
6-11				•			
7-11 NL					•		
Wide							
3-10							•
3-11 NL							
3-10 NL					•		•

Fig 20. Using IPG strips together with matching IPG Buffer improves the conductivity distribution across the pH gradient during IEF.

2.3 IEF using Ettan IPGphor 3 Isoelectric Focusing System and accessories

Ettan IPGphor 3 (Fig 21) is a fully integrated IEF system optimized to deliver high throughput, speed, reproducibility, and high protein-loading capacity, as well as optional PC control. The large graphical display accommodates multiple (up to four) lines of text for fast and easy programming. Up to 10 protocols (nine steps each) can be saved, retrieved, and easily edited on the instrument. Any number of protocols can be stored on a connected PC running IPGphor 3 Control Software and uploaded to the instrument instantly. Important safety features ensure safe high-voltage runs. Key accessories include Strip Holders, IPGbox, and Manifold. Ettan IPGphor 3 provides:

- Integral 10 000 V power supply
- Peltier solid-state temperature control (18–25 °C)
- Accommodation of one Manifold or 1–12 Strip Holders for 7-, 11-, 13-, 18-, or 24-cm IPG strips
- Programmable controller for voltage, current, temperature, and time



Fig 21. Ettan IPGphor 3.

2.3.1 Ettan IPGphor 3 Control Software

Ettan IPGphor 3 Control Software (Fig 22), with an external personal computer (Windows) connected via a serial port, can be used to control up to four Ettan IPGphor 3 units simultaneously, each running a different set of run parameters. With the software it is possible to:

- Create, save, and edit protocols
- Monitor voltage, current, and volt-hours of the run and generate graphical display as the run proceeds
- Open and view stored log files of previous runs
- Start, stop, and pause Ettan IPGphor 3
- Generate status report on Ettan IPGphor 3 (instantaneous run condition report on request)
- Enable Web browser remote monitoring of IPGphor 3
- Export log files to programs such as Microsoft™ Excel™
- Create professional reports that can be saved, printed, and exported

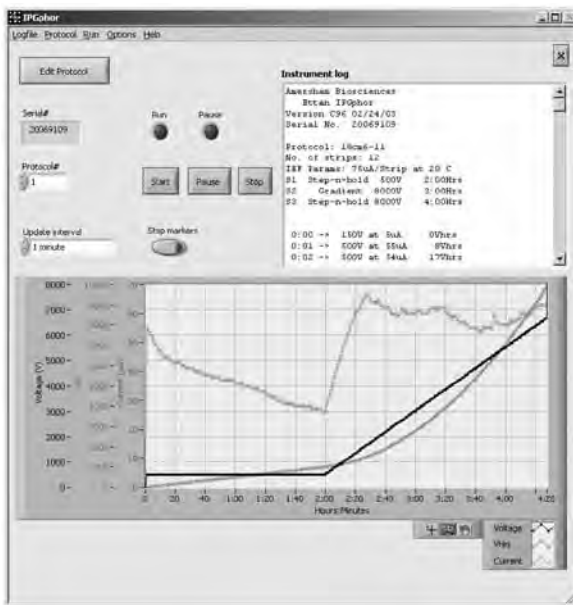

Fig 22. Ettan IPGphor 3 Control Software. For detailed instructions on installation and usage of this software, refer to the Ettan IPGphor 3 Control Software user manual.

2.3.2 Ettan IPGphor 3 Manifold

Ettan IPGphor 3 Manifold is an accessory for first-dimension IEF of proteins on IPG strips. The Manifold is designed to handle IEF and subsequent equilibration for up to 12 IPG strips. All strips in a given run must be of the same length. The Manifold can accommodate all IPG strip sizes from 7 to 24 cm. It comes with a complete set of accessories for 10 full runs of 12 strips each. It is also compatible with the first-generation Ettan IPGphor (see Ettan IPGphor user manual).

Cup-based sample application can improve protein-focusing patterns, particularly in basic IPG strips, and the Manifold accommodates either anodic or cathodic loading. Each cup can hold sample volumes of up to 150 μ l.

Under conditions where substantial water transport (electroendosmosis) accompanies focusing, such as with basic strips or with protein loads in excess of 1 mg, the face-up mode frequently yields improved resolution. Running strips gel side up has a number of advantages over the use of regular Strip Holders:

- It is easy to apply filter wicks at the electrodes: With preparative loads there is a more pronounced movement of water (due to electroendosmotic effects resulting from the extra proteins and potentially more salt/buffer carryover). This water movement is also more pronounced when working with basic IPG strips (pH ranges 6–9, 6–11, and 7–11 NL). Moistened prior to use, the paper wicks have the ability to absorb excess ions and buffers that move to the electrodes and that may otherwise perturb the focusing. They also serve to absorb the water accumulating at the cathodic side of the strip (as H_3O^+) and to keep the anodic side of basic strips hydrated (potentially they can dry out from the depletion of water). Moreover, since preparative loads are usually applied to narrow-range strips, the wicks will soak up the excess proteins that lie above and below the pH range being studied.
- It is easy to apply a cup to the surface of the gel for sample application: Cup loading can be advantageous for basic proteins (and also for very acidic proteins), mostly due to stability issues with these proteins once they reach their pI. Sharper spots can be obtained by loading samples away from their pI. Thus basic proteins would be loaded at the anodic side and acidic proteins at the cathodic side.
- The electrodes are fully adjustable to suit the length of strip: The Manifold can be used to run any IPG strip with a length between 7 and 24 cm. One to 12 strips, all of the same length, can be run at the same time.
- No pressure is exerted against the strip surface: Because the gel is run face side up, there is no pressure of the gel against the ceramic surface (such as in the regular Strip Holder). This is advantageous when running preparative loads as it lessens the streaking associated with abundant proteins.

There are, however, several drawbacks to running strips gel side up: the inability to apply voltage during rehydration; the extra manipulation of the strip from tray to Manifold; and the absence of active temperature control during the rehydration step.

 For best results with the basic IPG strips, in addition to anodic cup-loading, the use of DeStreak Reagent is highly recommended (see section 2.6.2).

The Manifold tray base is made of a thermally conductive aluminum oxide ceramic that rapidly dissipates heat to avoid potential “hot spots.” A further special coating of the surface eliminates protein absorption. The Manifold tray allows simple and accurate placement of IPG strips, with protrusions along the numbered inner channels that keep IPG strips straight and centered.

Pre-cut electrode pads and paper bridges are convenient and save valuable time. The wicks absorb excess water, salts, and proteins while the paper bridges can be used to load large sample volumes.

The overall procedure for use of Ettan IPGphor 3 with the Manifold is depicted in Figure 23. Following sections provide protocols for use of the various accessories.

 After IEF, proceed to the second-dimension separation immediately or store the Immobiline DryStrip gels at $-60\text{ }^{\circ}\text{C}$ or below, as described in section 2.8.3.

The Ettan IPGphor 3 platform is available in three application-based options for high-throughput analytical and micropreparative protein analysis. Table 15 summarizes these options.

Table 15. Several options based on application.

The complete solution	Ettan IPGphor 3 Isoelectric Focusing Unit plus Ettan IPGphor Manifold, IPGbox, ceramic Strip Holders to run 7-, 11-, 13-, 18-, or 24-cm IPG strips, and appropriate IPG strips and buffers
For high-throughput micropreparative applications	Ettan IPGphor 3 Isoelectric Focusing Unit plus Ettan IPGphor Manifold, IPGbox, and appropriate IPG strips and buffers
For analytical study of protein profiles	Ettan IPGphor 3 Isoelectric Focusing Unit plus ceramic Strip Holders and appropriate IPG strips and buffers



1. Rehydrate IPG strips

Rehydrate Immobiline DryStrip gels, with the gel side down, in the appropriate volume of rehydration solution, using IPGbox. Allow the IPG strips to rehydrate overnight (10–20 h).



5. Moisten and place electrode pads

Wet the pre-cut electrode pads with 150 μ l deionized water and place the pads on the ends of the IPG Strips.

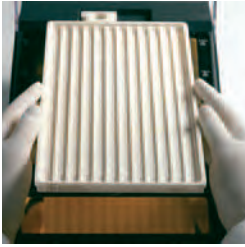

2. Position Manifold

Position the Manifold on Ettan IPGphor 3. The small T-shaped protrusion fits into the cutout section of the Ettan IPGphor 3 bed, making positioning easy.



6. Position electrode assembly

Slide an electrode assembly over the top of all the pads. Swivel the cams into the position under the external lip of the Manifold to seat the electrode in place.



3. Transfer IPG strips to Manifold

Pour the appropriate volume (108 ml) of Immobiline DryStrip Cover Fluid evenly in all the channels. Transfer the IPG strips to the Ettan IPGphor 3 Manifold. Place them face up in the tray with the anodic (+) end of the strip resting on the appropriate mark etched on the bottom of the Manifold track.

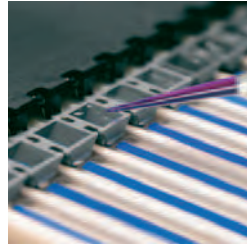

7. Load and cover samples

Load the samples into the sample cups, up to a maximum of 150 μ l. Check to make sure that the samples are completely covered with DryStrip Cover Fluid.

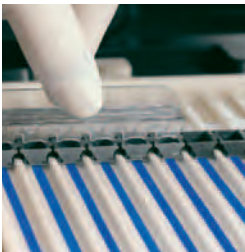

4. Seat cups in track (if cup loading)

Place a strip of cups in the appropriate position. The convenient seating tool enables you to push the cups down so that they are properly seated at the bottom of the track.



8. Set program parameters and run

Close the Ettan IPGphor 3 cover. Select program and enter desired run parameters and begin the run.

Fig 23. Summary of the steps involved in first-dimension IEF using Ettan IPGphor 3, IPGbox, and Manifold.

2.3.3 IPGbox

IPGbox and IPGbox Kit are tools for enhancing the reswelling of GE Healthcare's precast Immobiline DryStrip Gels. It provides a convenient method for rehydrating up to twelve precast IPG strips (7 to 24 cm) at a time. Individual slots in the Reswell Trays allow rehydration of individual IPG strips in a minimum volume of solution. The IPGbox includes a lid that protects the strips from dust and other contaminants during the rehydration period, which ranges from 10 h to overnight.

2.3.4 Ettan IPGphor 3 Strip Holders

IPGphor Strip Holder serves as both a rehydration and focusing chamber for individual IPG strips. When the sample is included in the rehydration solution, it is loaded into the gel by absorption during the rehydration step. Since the gel is in direct contact with electrodes built into the Strip Holder, it is placed in position to run without further handling. The base of the Strip Holder is made from the same thermally conductive aluminum oxide ceramic as the Manifold and has platinum electrodes at each end. The transparent Strip Holder cover allows easy visual monitoring of rehydration and focusing progress.

2.3.5 General cautions



Ettan IPGphor 3 is a high-voltage instrument that can cause fatal electrical shock if the safety features are disabled. As such, the safety lid must be properly latched before starting a protocol, otherwise voltage will not be applied.



Exceeding the recommended current limit of 75 μ A per IPG strip can cause the strip to burn and may damage the instrument.



During isoelectric focusing, do not lean on the safety lid, do not apply excess pressure or uneven weight to the lid, and do not place any items on the lid. Such pressure could cause arcing between the Strip Holder electrodes and the electrode areas, damaging the instrument.



The Strip Holders and Manifold trays are made of ceramic and should be handled carefully.



Always wear gloves when handling IPG strips and the equipment that comes in contact with them. This will help minimize protein contamination, which can result in artifactual spots in the resulting 2-D spot patterns.



Clean Strip Holders and Manifold with the Strip Holder cleaning solution provided or the protective coating will be compromised. Clean all other components that come in contact with the IPG strip or the sample with a detergent designed for glassware. Rinse well with distilled water.



Use the appropriate rehydration volume for the IPG strip length (refer to appropriate protocol).



Do not heat any solutions containing urea above 30 °C as isocyanate, a urea degradation product, will carbamylate the proteins in the sample, thus changing their isoelectric points.



All chemicals should be of the highest purity (electrophoresis grade or better), and water should be double distilled or deionized.

2.4 Selecting sample application method

Sample can be applied either by including it in the rehydration solution (rehydration loading) or by applying it directly to the rehydrated Immobiline DryStrip gel via sample cups or a paper bridge.

2.4.1 Rehydration loading

Rehydration loading (see section 2.7) offers such advantages as loading and separation of larger sample volumes (greater than 100 μ l) (70, 71), larger sample amounts, and more dilute samples. Because there is no discrete application point, this method eliminates the formation of precipitates at the application point that may occur when loading using sample cups. Also, the method is technically simpler than the others, avoiding problems of leakage that can occur when using sample cups.

2.4.2 Use of Manifold

There are cases when it may be preferable to load the sample following rehydration, immediately prior to IEF. For example, if proteolysis or other protein modifications are a concern, overnight rehydration with sample may not be desirable. The Manifold (see section 2.7) provides a convenient means to load samples under such circumstances. Cup loading using the Manifold is recommended for sample volumes up to 150 μ l, and a maximum protein concentration of 150 μ g protein/150 μ l sample solution (150 μ l is the volume of the cup). Larger sample loads can lead to increased protein precipitation at the point of application.

Anodic cup loading has been found to improve protein 2-D spot patterns with basic Immobiline DryStrip gels (pH 6–9, pH 6–11, and pH 7–11 NL). Under conditions where substantial water transport (electroendosmosis) accompanies focusing, such as with protein loads in excess of 1 mg, the face-up mode frequently yields better resolution. See section 2.3.4 for a more detailed discussion of the face-up mode.

2.4.3 Paper-bridge loading

Paper-bridge loading is ideal for very large sample volumes and preparative electrophoresis, and is particularly applicable when using basic pH intervals (pH 6–9, pH 6–11, and pH 7–11 NL).

Paper-bridge loading can also be performed in the Manifold. Using 18- or 24-cm Immobiline DryStrip gels, up to 450 μ l can be applied using the paper-bridge method.

Details of appropriate sample loads for analytical and preparative loading and cup loading using the Manifold are given in Table 16 (see section 2.5).

Figure 24 gives general guidelines on selecting the appropriate mode of sample application.

pH gradient	Analytical		Preparative	
	Strip Holder	Manifold		Manifold
3.5–4.5		Rehydration loading		Rehydration loading
3.0–5.6 NL		Rehydration loading		Rehydration loading
4.0–7.0	Rehydration loading	Rehydration loading		Rehydration loading
3.0–7.0 NL	Rehydration loading	Rehydration loading	Cup loading	Rehydration loading
5.3–6.5	Rehydration loading	Rehydration loading	Cup loading	Rehydration loading
3.0–10.0				
3.0–10.0 NL				
3.0–11.0 NL				
6.2–7.5				
6.0–9.0			Cup loading	paper-bridge loading
6.0–11.0			Cup loading	paper-bridge loading
7.0–11.0 NL				

Fig 24. Guidelines for selecting the appropriate mode of sample application in the Ettan IPGphor 3 Isoelectric Focusing System.

Refer to section 2.7 for more details on sample application.

2.5 Recommended sample loads

Recommended sample loads for silver (for analytical analysis) and Coomassie (for preparative analysis) staining are shown in Table 16. 2-D Quant Kit (see section 1.7.1) can be used to determine the protein concentration prior to first-dimension IEF.

Table 16. Suitable sample loads* for silver and Coomassie staining using cup loading and rehydration loading.

Immobiline DryStrip gel length (cm)	(pH)	Suitable sample load (µg of protein)		CyDye™
		Silver stain (analytical)	Coomassie stain (preparative)	
7	3–11 NL, 3–10 NL, 3–10	3–6	25–60	10
	4–7	4–8	25–150	13
	3–5.6 NL, 5.3–6.5, 6.2–7.5, 6–11, 7–11 NL	8–16	40–240	26
11	3–11 NL, 3–10	7–15	50–120	20
	4–7	10–20	50–300	28
	6–11, 3–5.6 NL, 5.3–6.5, 6.2–7.5, 7–11 NL	20–40	100–600	56
13	3–11 NL, 3–10 NL, 3–10	10–20	50–240	25
	4–7	15–30	75–450	38
	6–11 narrow and medium intervals†	30–60	150–900	76
18	3–11 NL, 3–10 NL, 3–10	20–40	100–500	50
	4–7	30–60	150–900	75
	6–11, 6–9, narrow and medium intervals‡	60–120	300–1500	150
24	3–11NL, 3–10 NL, 3–10	30–60	200–600	100
	4–7, 3–7 NL	45–90	200–1300	150
	6–9, narrow and medium intervals‡	80–200	400–2000	300

* When using cup loading, an increased sample concentration will lead to an increased risk of protein precipitation in the sample cup. A maximum concentration of 150 µg protein/150 µl sample solution (150 µl is the volume of the cup) is recommended. This is a general recommendation, which will function for most samples, but the maximum concentration usable varies greatly between sample types.

For larger sample loads, rehydration loading is recommended.

† Immobiline DryStrip gels, pH intervals: 3–5.6 NL, 5.3–6.5, 6.2–7.5, and 7–11 NL.

‡ Immobiline DryStrip gels, pH intervals: 3–5.6 NL, 5.3–6.5, 6.2–7.5, 7–11 NL, 3.5–4.5, 4.0–5.0, 4.5–5.5, 5.0–6.0, and 5.5–6.7.

2.6 Immobiline DryStrip gel rehydration solutions

Immobiline DryStrip gels must be rehydrated prior to IEF. They should be rehydrated in the Immobiline DryStrip IPGbox when the Manifold is used with Ettan IPGphor 3 and also when Multiphor II Electrophoresis System is used. When using Ettan IPGphor 3 and standard Strip Holders, the strips should be rehydrated in the Strip Holders themselves.

Rehydration solution, which may or may not include the sample, is applied to the reservoir channels of the Immobiline DryStrip IPGbox or Strip Holder, and then the Immobiline DryStrip gels are soaked individually.

There are two general rehydration methods: (1) passive rehydration, in which no electric field is applied during the process, and (2) active rehydration, which is rehydration under low voltage (20–120 V). Active rehydration can facilitate the entry into the strip of high-molecular-weight proteins (70). Passive rehydration can be done in the Strip Holder or IPGbox, but active rehydration can be done only in the Strip Holder. Procedures for using both Strip Holders and the IPGbox are described below, in section 2.7.



The IPGbox, a separate product, is required for proper strip rehydration when using the Manifold. The channel in the Manifold is too wide to ensure proper absorption of the required volumes of rehydration solution.



The lid of IPG box prevents the strips from drying during rehydration thus eliminating the possibility of urea crystallization and the need for Immobiline DryStrip Cover Fluid.

2.6.1 Components of rehydration solution

The choice of the most appropriate rehydration solution for the sample will depend on its specific protein solubility requirements. A typical solution generally contains urea, nonionic or zwitterionic detergent, DeStreak Reagent or DTT, the appropriate Pharmalyte or IPG Buffer (all available from GE Healthcare), and a tracking dye. The sample may also be included. The role of each component is described below, as well as the recommended concentration range.

Urea solubilizes and denatures proteins, unfolding them to expose internal ionizable amino acids. Commonly, 8 M urea is used, but the concentration can be increased to 9 or 9.8 M if necessary for complete sample solubilization.

Thiourea, in addition to urea, can be used to further improve protein solubilization, particularly for hydrophobic proteins (10, 16, 55–57). When using both, the recommended concentration of urea is 7 M and that of thiourea 2 M.

Detergent solubilizes hydrophobic proteins and minimizes protein aggregation. The detergent must have zero net charge—use only nonionic or zwitterionic detergents. CHAPS, Triton X-100, or NP-40 in the range of 0.5 to 4% are most commonly used.

DeStreak Reagent overcomes the problems of streaking that commonly occur due to reoxidation when running gels that contain basic regions above pH 7. The reagent stabilizes thiol groups such as disulfides, thus reducing streaking and extra spots caused by various oxidation stages of proteins (62). See section 2.6.2 for more information and a protocol for use of this reagent.

DeStreak Rehydration Solution contains DeStreak Reagent, as described above. The Rehydration Solution also contains optimized concentrations of urea, thiourea, and CHAPS, and is ready for use after addition of the appropriate IPG Buffer.

IPG Buffer or Pharmalyte (carrier ampholyte mixtures) improves separations, particularly with high sample loads. Carrier ampholyte mixtures enhance protein solubility and produce more uniform conductivity across the pH gradient without disturbing IEF or affecting the shape of the gradient. IPG Buffers are carrier ampholyte mixtures specially formulated not to interfere with silver staining following 2-D electrophoresis. Select an IPG Buffer with the same pH interval as the Immobiline DryStrip to be rehydrated (Table 17).

The advantages of increased concentration of IPG Buffer/Pharmalyte are:

- Improved sample solubilization
- Increased tolerance to salt in sample
- More even conductivity in the gel



Higher concentrations of IPG Buffer/Pharmalyte will limit the voltage usable during IEF and increase the time required for the focusing step.



Silver staining may require a prolonged fixing step to wash out carrier ampholyte that may cause staining background near the ion front of the second-dimension gel.



IPG Buffer or Pharmalyte can be included in the stock rehydration solution or added just prior to use. The carrier ampholytes are included in the stock solution when multiple Immobiline DryStrip gels of the same pH range are to be used. Carrier ampholytes are added to single aliquots of the stock solution when the same stock solution will be used with different pH range Immobiline DryStrip gels.



Tracking dye (bromophenol blue) allows IEF progress to be monitored during the protocol. If the tracking dye does not migrate toward the anode, no current is flowing. Note: the dye migrates to the end of the strip well before the sample is focused!



Sample can be applied by including it in the rehydration solution. Up to 1 mg of sample per strip (dependent on the length of the strip and the pH range) can be diluted or dissolved in rehydration solution prior to IEF. The amount of sample required is dictated in part by the detection or visualization method used. For example, radiolabeling requires a very small amount of sample whereas Coomassie blue staining requires larger sample amounts.

2.6.2 Using DeStreak Rehydration Solution

Nonspecific oxidation of protein thiol groups is a common problem during 2-D electrophoresis, especially at pH > 7. In the resulting protein map, this problem manifests as horizontal streaks and extra spots.

DeStreak Reagent and DeStreak Rehydration Solution act to transfer thiol groups in proteins to stable disulfide groups, thus preventing nonspecific oxidation. This will reduce streaking between spots in the protein map, especially in the pH range 7–11, and also simplify the spot pattern by reducing the number of spots caused by protein oxidation (compare A and B in Figure 25).

When rehydrating Immobiline DryStrip gels with solutions other than DeStreak Rehydration Solution, DeStreak Reagent can be added to the sample solution to stabilize thiol groups and prevent nonspecific oxidation. DeStreak Reagent is compatible with most sample solutions as long as they do not contain more than 20 mM reducing agents, such as dithiothreitol (DTT), β -mercaptoethanol, or tris(2-carboxyethyl)phosphine (TCEP).

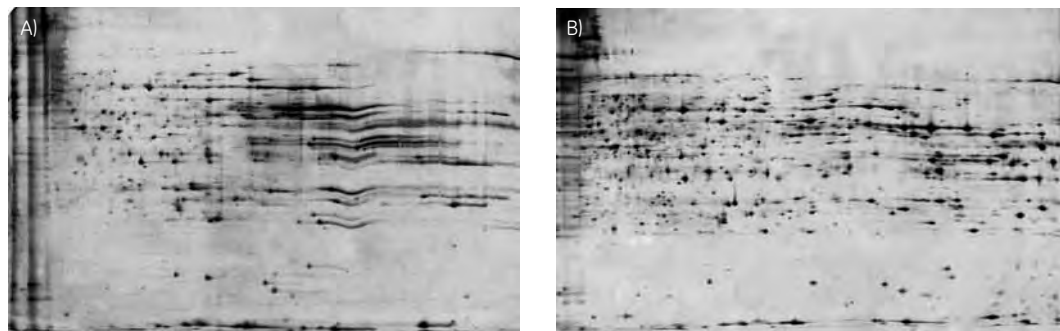

Fig 25. A. Without DeStreak Rehydration Solution. Anodic cup loading. Sample (100 μ l, 0.8 mg/ml mouse liver protein) contained 8 M urea, 0.5% CHAPS, 1% Pharmalyte pH 8–10.5, and 10 mM DTT. Immobiline DryStrip gel, pH 6–9, 24 cm, rehydrated in 1% IPG Buffer pH 6–11 with 8 M urea, 0.5% CHAPS, and 10 mM DTT. B. With DeStreak Rehydration Solution. Anodic cup loading. Sample (100 μ l, 0.8 mg/ml mouse liver protein) contained 8 M urea, 0.5% CHAPS, 1% Pharmalyte pH 8–10.5, and 10 mM DTT. Immobiline DryStrip gel, pH 6–9, 24 cm, rehydrated in DeStreak Rehydration Solution and 1% IPG Buffer pH 6–11.

Protocol: DeStreak Rehydration Solution

Reagents supplied

DeStreak Rehydration Solution (5 \times 3 ml).

Required but not provided

Sample buffer containing reducing agents (up to 20 mM), such as DTT, β -mercaptoethanol, or tris(2-carboxy-ethyl)phosphine (TCEP); IPG Buffer or Pharmalyte.

Preliminary steps

Before use, equilibrate DeStreak Rehydration Solution at room temperature for 30 min. Shake the bottle to dissolve the urea crystals.

Sample preparation

1. Prepare the protein extract in sample buffer containing reducing agents, such as dithiothreitol (DTT), β -mercaptoethanol, or tris(2-carboxyethyl)phosphine (TCEP), at a concentration of 20 mM.

Note: Using cup application, the sample solution may contain up to 1 mg of protein/ml. Using anodic paper-bridge loading, higher concentrations can be used.

Preparation of DeStreak Rehydration Solution

1. DeStreak Rehydration Solution is supplied without IPG Buffer. Before use, add 15 μ l (0.5%) or 60 μ l (2.0%) of the appropriate IPG Buffer or Pharmalyte to 3 ml of DeStreak Rehydration Solution.



Use 0.5% IPG Buffer in the DeStreak Rehydration Solution when:

- IPGphor standard Strip Holder is used for the first dimension.

- Horizontal gels are used in the second dimension.
- 10 kV is used in the Manifold.
- Immobiline DryStrip 7–11 NL and 3–11 NL are used. This will give a high voltage and a short run time in hours, both of which are essential for streak-free results.



Use 2.0% IPG Buffer in the DeStreak Rehydration Solution in cases where the highest solubility of proteins and stability against salt are needed. Under these conditions, conductivity will be higher and the highest voltage may not be reached.

Note: Select an IPG Buffer with the same pH interval as the Immobiline DryStrip being rehydrated. See Table 17 for buffers.

Table 17. Immobiline DryStrips and IPG buffers.

Immobiline DryStrip	IPG Buffer
pH 3.5–4.5, 3–5.6 NL	3.5–5.0
pH 3–7 NL, 4–7	4–7
pH 3–10	3–10
pH 3–10 NL	3–10 NL
pH 3–11 NL	3–11 NL
pH 5.3–6.5	5.5–6.7
pH 6–9, 6–11, 6.2–7.5	6–11
pH 7–11 NL	7–11 NL

Rehydration of Immobiline DryStrips

1. Pipette the appropriate volume of prepared DeStreak Rehydration Solution into the Reswell Tray or into the regular Strip Holder as indicated in Table 18. Distribute the solution evenly over the channel length.
2. Carefully remove the cover foil from the Immobiline DryStrip, starting from the anodic end (+ end).
3. Carefully place the Immobiline DryStrip into the tray/holder channel, gel-side down. Take care to distribute the rehydration solution evenly under the strip. To help coat the entire gel, gently lift and lower the strip and slide it back and forth along the surface of the solution. Be careful not to trap bubbles under the Immobiline DryStrip gel.
4. Close the lid to the IPGbox..
5. Rehydrate for 10–20 h.

Sample application

1. Load the sample either in the rehydration solution or after rehydration using a sample cup or anodic paper bridge.
 - With acidic pH intervals (3.5–4.5, and 3–5.6 NL), we recommend rehydration loading or cathodic sample cup application. Use up to 20 mM reducing agent per 100 µl of sample.
 - With neutral (5.3–6.5, and 4–7) and wide (3–10) pH intervals, all sample application methods can be used, but sample-specific limitations may exist. Use up to 10 mM reducing agent per 100 µl of sample.
 - With basic Immobiline DryStrip (pH intervals 6.2–7.5, 6–9, 6–11, and 7–11 NL), we recommend anodic cup application or anodic paper-bridge loading. Use up to 20 mM reducing agent per 100 µl of sample.
 - Using rehydration loading on basic strips, the sample (in rehydration solution) may contain up to 1 mM reducing agent. This reducing power will be consumed during the rehydration step and early start of the run, and thiols will be transferred to disulfides during the run.

Table 18. Rehydration solution volume per Immobiline DryStrip—Ettan IPGphor 3 protocol.

Immobiline DryStrip gel length (cm)	Total volume per strip* (μl)
7	125
11	200
13	250
18	340
24	450

* Including sample, if applied.

Run

Run the gels according to the instructions included with the Immobiline DryStrip package.

Protocol: DeStreak Reagent

Reagents supplied

DeStreak Reagent (1 ml).

Required but not provided

Rehydration solution without reducing agents; sample buffer containing reducing agents (up to 20 mM), such as DTT, β-mercaptoethanol, or tris(2-carboxyethyl)phosphine (TCEP).

1. Prepare DeStreak Reagent for use by adding 12 μl (15 mg) of DeStreak Reagent per ml of rehydration solution containing no reducing agents.
2. Follow the steps for sample preparation, application, and gel run as previously provided for DeStreak Rehydration Solution.

2.6.3 Preparation of other rehydration solutions

Typical compositions of rehydration solutions are given in appendix I, solutions C and D.

2.7 Immobiline DryStrip Gel rehydration using accessories

This section includes protocols for use of the Strip Holder, IPGbox, and Manifold. It covers the following scenarios:

- Using Strip Holders for rehydration loading (sample included) or sample loading after gel rehydration.
- Using IPGbox prior to using the Manifold (sample added prior to reswelling or after reswelling using cup or paper-bridge loading).

For rehydration sample loading, the Immobiline DryStrip gel must be rehydrated in the Immobiline DryStrip IPGbox or in the standard Strip Holder. Mix the sample with rehydration solution (see section 2.5 for recommended sample loads). When the Immobiline DryStrip gels are rehydrated with the sample proteins, sample cups are not used. This approach is referred to as passive rehydration. In some cases, rehydration under voltage, referred to as active rehydration, might be preferred. Rehydration under low voltage (20–120 V) facilitates the entry of high-molecular-weight proteins (70). Active rehydration is possible only in the Strip Holder.

Large sample volumes and large protein amounts can be applied using paper-bridge loading (Manifold only). For example, for basic proteins, a paper pad (paper bridge) is soaked with sample and placed between the anodic end of the Immobiline DryStrip gel and the electrode (375–500 μl sample can be applied using the paper-bridge pads supplied with the Manifold). Solutions containing up to 5 mg of protein have been loaded on an 18-cm narrow-pH range Immobiline DryStrip gel (74).



A standard paper electrode pad between the paper bridge and the electrode improves sample transfer and gel results.

The rehydrated Immobiline DryStrip gel is first positioned in the bottom of the Manifold channel, gel side up. Then the paper bridge with sample is positioned, followed by a paper wick. With anodic application the anode electrode is positioned as far out as possible in the electrode assembly, while the cathode electrode is positioned close to the end of the Immobiline DryStrip gel to ensure good contact between the paper wick and Immobiline DryStrip gel.

 The application point (anodic or cathodic) is an important factor for obtaining good results.

 A single paper bridge can be used with the 24-cm gel strip. If so desired, a paper bridge can be used on both ends of all other strips at one time.

Protocol: Using the Strip Holder for gel rehydration

IPGphor fixed-length Strip Holders allow IPG strips to be rehydrated and samples loaded in one step before proceeding automatically to perform the IEF separation. The IPG strips are 3 mm wide and 0.5 mm thick after rehydration.

This protocol applies for both in-gel sample rehydration and sample application after gel rehydration. In the latter case, see Note C below.

1. Prepare the Strip Holder(s)

Select the Strip Holder(s) corresponding to the Immobiline DryStrip gel length chosen for the experiment.



Handle the ceramic Strip Holders with care.



It is essential to wash each Strip Holder with detergent to remove residual protein. Use a neutral pH detergent, such as the Strip Holder Cleaning Solution, to remove residual protein from the Strip Holders. Strip Holder Cleaning Solution has been specifically formulated to remove protein deposits and will not damage the Strip Holder. Strip Holder Cleaning Solution is available in 950-ml bottles (see ordering information).

1. Clean Strip Holders after each first-dimension IEF run. Do not let solutions dry in the Strip Holder. Cleaning may be more effective if the Strip Holders are first soaked for a few hours or overnight in a solution of 2–5% Strip Holder Cleaning Solution in water. First rinse off the Strip Holder to remove any residual DryStrip Cover Fluid.
2. Squeeze a few drops of Strip Holder Cleaning Solution into the Strip Holder channel. Use a toothbrush and vigorous agitation to clean the Strip Holder.
3. Rinse well with distilled or deionized water. Thoroughly air-dry the Strip Holders or dry well with a lint-free tissue prior to use.
Recalcitrant or dried-on protein deposits may be removed with hot (up to 95 °C) 1% (w/v) SDS. Add 1% (w/w) DTT for complete removal of sticky proteins. Rinse thoroughly with distilled or deionized water after cleaning.



Handle clean Strip Holders with gloves to avoid contaminating them. Strip Holders may be baked, boiled, or autoclaved. DO NOT EXPOSE THEM TO STRONG ACIDS OR BASES, INCLUDING ALKALINE DETERGENTS.



The Strip Holder must be completely dry before use.

2. Apply the rehydration solution

Pipette the appropriate volume of rehydration solution into each Strip Holder as indicated in Figure 26. Deliver the solution slowly as a stripe of liquid between the two electrodes, away from the sample application wells (Fig 26). Remove any large bubbles.

For a typical composition of rehydration solution, see appendix I, solution C. If in-gel sample rehydration is desired, add the appropriate amount of sample to the rehydration solution. Recommended loads are shown in Table 16 (section 2.5).



To ensure complete sample uptake, do not exceed the recommended volume of rehydration solution, see Table 18 (section 2.6.2).

3. Position the Immobiline DryStrip gel

Remove the protective cover foil from the Immobiline DryStrip gel starting at the acidic (+) end. Removal from the acidic end prevents damage to the basic end of the gel, which is generally softer. Using forceps, position the Immobiline DryStrip gel with the gel side down and the anodic (+) end of the strip directed toward the pointed end of the Strip Holder (Fig 27). Acidic end first, lower the gel onto the solution. To help coat the entire strip, gently lift and lower the strip and slide it back and forth along the surface of the solution, tilting the Strip Holder slightly as required to ensure complete and even wetting. Finally, lower the cathodic end of the Immobiline DryStrip gel into the channel, making sure that the gel contacts the Strip Holder electrodes at each end. (The gel can be visually identified once the rehydration solution begins to enter the gel.) Be careful not to trap air bubbles under the Immobiline DryStrip gel.

4. Apply Immobiline DryStrip Cover Fluid

Apply Immobiline DryStrip Cover Fluid to minimize evaporation and thus prevent urea crystallization. Pipette the fluid dropwise into one end of the Strip Holder until one half of the Immobiline DryStrip gel is covered. Then pipette the fluid dropwise into the other end of the Strip Holder, adding fluid until the entire gel is covered.

5. Place the cover on the Strip Holder

Pressure blocks on the underside of the cover ensure that the Immobiline DryStrip gel maintains good contact with the electrodes as the gel swells.

6. Allow the Immobiline DryStrip gel to rehydrate

Rehydration can proceed on the bench top or on the Ettan IPGphor 3 platform. Ensure that the Strip Holder is on a level surface. A minimum of 10 h is required for rehydration; overnight is recommended. The rehydration period can be programmed as the first step of an Ettan IPGphor 3 protocol. This is especially convenient if temperature control during rehydration is a concern.

 Active rehydration (20–120 V) can also be performed if sample is included.

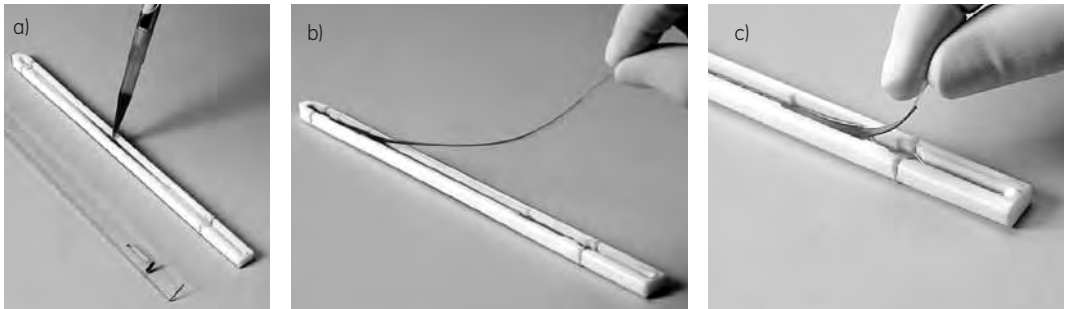

Fig 26. Applying rehydration solution into the Strip Holder. (a). Positioning the Immobiline DryStrip gel (b, c). Positioning the Immobiline DryStrip gel.

A. Rehydration loading

A discussion of the advantages of rehydration loading can be found in section 2.4.

B. Optional: Apply electrode pads

During IEF, the transport of ions, proteins, and IPG Buffer between the electrodes is accompanied by transport of water. For large sample loads and when using narrow-pH-range Immobiline DryStrip gels, better results are obtained by applying damp paper pads between the Immobiline DryStrip gel and each Strip Holder electrode following rehydration but before IEF, in order to absorb excess water.

1. Prepare electrode pads

Use the paper wicks (accessory to the Manifold) or cut two 3-mm-wide electrode pads from a paper IEF electrode strip. Place on a clean, flat surface such as a glass plate and soak with deionized water. Remove excess water by blotting with tissue paper.

 Electrode pads must be damp, not wet.

2. Position electrode pads

Using forceps, lift one end of the rehydrated Immobiline DryStrip gel. Position an electrode pad over the electrode, then lower the gel strip back into place. Repeat at the other end.

 Additional DryStrip Cover Fluid may need to be added to ensure that the strip is still adequately covered.

C. Apply sample after gel rehydration

If the sample was not applied as a part of the rehydration solution, it can be applied immediately prior to IEF.

1. Prepare sample

Prepare the sample in a solution similar in composition to the rehydration solution used.

2. Apply sample

Pipette the sample into either or both of the lateral wells at either end of the Strip Holder (Fig 27). Introduce the sample below the Immobiline DryStrip Cover Fluid.

Up to 7.5 μ l of sample solution can be added to each side (i.e. 15 μ l per well or 30 μ l total if both sides of both wells are used).



The Immobiline DryStrip gel backing is impermeable; do not apply the sample to the back of the strip. Replace cover on Strip Holder.

Refer to Table 18, section 2.6.2 for rehydration solution volume per Immobiline DryStrip.



Fig 27. Applying sample after gel rehydration.

Protocol: Using IPGbox for Rehydration

If the Manifold is used, Immobiline DryStrip gels must be rehydrated prior to IEF in the Immobiline DryStrip IPGbox. Rehydration can take place with or without the sample included.



Do not use the Manifold for rehydration.

Each tray has 12 independent reservoir channels that can each hold a single Immobiline DryStrip gel up to 24 cm long. Separate channels allow the rehydration of individual gel strips with no danger of spillover into adjacent lanes.

- 1 Select and prepare a rehydration solution, see Section 2.6.1.
- 2 Place the IPGbox on a levelled table and place a Reswell Tray in the IPGbox. Ensure that the Reswell Tray and the IPGbox Insert are clean and dry. If required, wipe the IPGbox Insert with a soft tissue moistened with 70% ethanol.
- 3 Pipette the appropriate volume of selected rehydration solution (and sample if applied) evenly over the slots corresponding to the length of the DryStrip gels. See Table 18 for rehydration solution volumes. Strip lengths are measured from the straight ended part of the wells of the Reswell Tray and marked with lines on the top of the Reswell Tray.

Note: For complete sample uptake, do not apply excess rehydration solution.

- 4 Carefully pull off the cover film from Immobiline DryStrip gel and place Immobiline DryStrip gel into the slot, gel-side down. Distribute the rehydration solution evenly under the strip. Gently lift and lower the strip and slide it back and forth along the surface of the solution to get complete and even wetting of the entire gel.

Note: Ensure that no bubbles are trapped under the Immobiline DryStrip gel.







Fig 28. Example of IPG strips in a Reswell Tray.

- 5 Gently close the lid of the IPGbox and allow the Immobiline DryStrip gels to rehydrate at room temperature for 10-24 hours (overnight is recommended).
- 6 Use the Immobiline DryStrip gels within 20 minutes of opening the IPGbox. Discard the used Reswell Tray.

Note: Do not store the Reswell Tray in IPGbox. Long time pressure of a Reswell Tray can reduce the life span of the IPGbox Insert.

Protocol: Preparing the Manifold

1. Clean and dry the IPGphor 3 bed before placing the Manifold tray on the unit. Position the Manifold on the IPGphor 3 platform. The small T-shaped protrusion fits into a cutout section of the IPGphor bed near the lid hinge (Fig 29). Ensure that the Manifold is level by placing the round spirit level on the center of the Manifold tray after it is placed on the Ettan IPGphor 3 unit. Adjust leveling feet if necessary.
 -  Important! Before proceeding, make sure the Ettan IPGphor 3 unit is placed on a level surface.
 -  Important! If using the original Ettan IPGphor, ensure that the three foam pads have been removed from the lid of the unit. (This step is not necessary if using Ettan IPGphor 3.)
2. Measure out 108 ml of Immobiline DryStrip Cover Fluid (even if fewer than 12 strips will be loaded into the Manifold). Add the cover fluid evenly between the 12 Manifold channels. Transfer the strips to the Ettan IPGphor Manifold. Place the strips under the cover fluid, gel side up in the tray with the anodic (+) end of the IPG strip oriented toward the anodic side of the instrument. Position the strip to rest on the appropriate mark etched into the bottom of the Manifold channel (the end of the gel, not the end of the plastic, should align with the etched mark). Center the strip down the length of the Manifold channel. Protrusions along the sides guide the strip approximately straight, although some manual adjustment of the strip may be necessary (Fig 30).

Note: If cathodic cup loading is going to be used, the strips should be placed such that the anodic end of the strips is 3-4 cm beyond the etched placement mark.
3. If performing cup loading, place a strip of cups in the appropriate position (Fig 31), for example ~1 cm from the end of the gel portion of the IPG strip. Do NOT place the cup with the feet over a center protrusion. Push the cups into the channels with gloved fingers, starting at one end and working toward the other. Align the insertion tool over the cups and push down to ensure that the feet of the cups are properly seated at the bottom of the channel (wiggle the tool gently while pushing down in order to ensure that the cups are seated as far down as they will go). Take care not to move the cups while removing the insertion tool. Ensure that the cups are filled with cover fluid.
 -  If desired, test for leakage by adding some colored sample buffer (without sample). If no leaks are detected, pipette the colored liquid back out again.
 -  Cups must not straddle the centering protrusions on the bottom of the channels.
4. Count out the appropriate number of precut paper wicks. Two wicks per strip are required. Separate the wicks from each other. Add 150 μ l of distilled water to each wick. Place the wicks on the IPG strips such that one end of the wick overlaps the end of the gel on the IPG strip (Fig 32). For gradients with pH above 9, add 150 μ l DeStreak rehydration solution to the cathodic wick. The electrode must contact the wick. With the electrode cams in the open position, place the electrode assembly on top of all the wicks. Swivel the cams into the closed position under the external lip of the tray. The electrodes should not be moved while the cams are in the closed position (Fig 33).
5. Briefly centrifuge the protein sample (e.g. at top speed in a microcentrifuge) prior to loading to remove insoluble material and particulate matter. These materials could impede sample entry and result in vertical streaks in the second-dimension gel. Load samples into the sample cups. A maximum of 150 μ l of sample may be placed in these cups. Check to make sure that there is cover fluid over the samples. When the cups are initially placed on the Manifold, cover fluid will flow into the cups as they are seated. When sample is introduced into the cups, the sample will sink to the bottom of the cup and contact the IPG strip.

Note: For basic IPG strips, superior focusing patterns are generally obtained when the sample cup is placed as close to the anodic (+) electrode as possible.

- Close the Ettan IPGphor 3 lid. Program the Ettan IPGphor 3 with the desired run parameters. Ramping the voltage slowly while the sample is entering the IPG strip will improve results. See section 2.8 for further discussion on this topic. Optimal ramp, voltages and times, or Vhr (volt-hours) totals must be determined empirically for each sample type. Focusing after sample cup application frequently requires fewer Vhr than in-gel sample rehydration loading methods, particularly on basic pH-range strips.

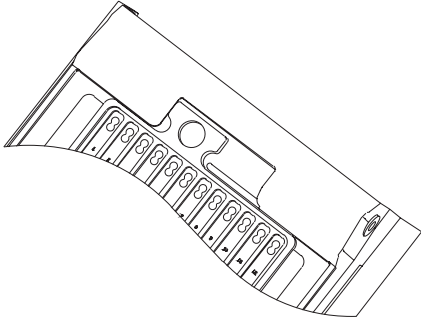

Fig 29. Manifold placement on Ettan IPGphor 3.

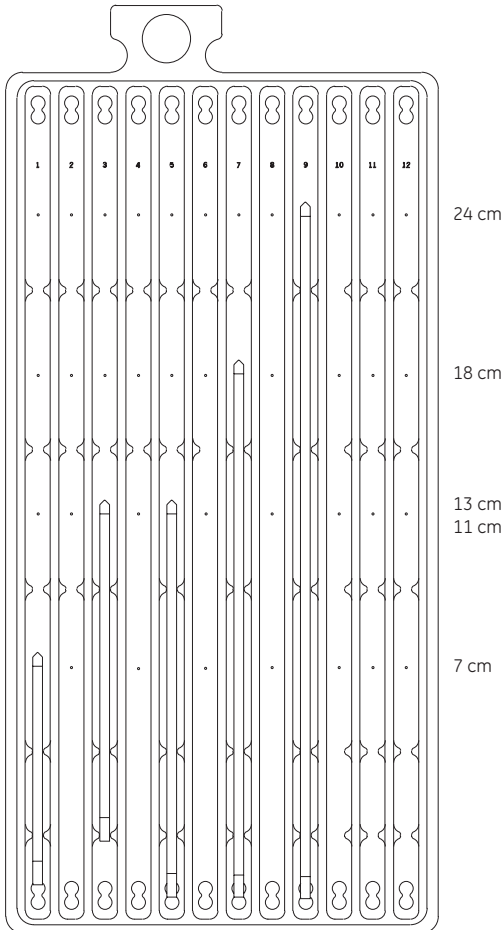

Fig 30. Placement of IPG strips in Manifold channels.
Note: If cathodic cup loading is going to be used, the strips should be placed such that the anodic end of the strips is 3-4 cm beyond the etched placement mark.

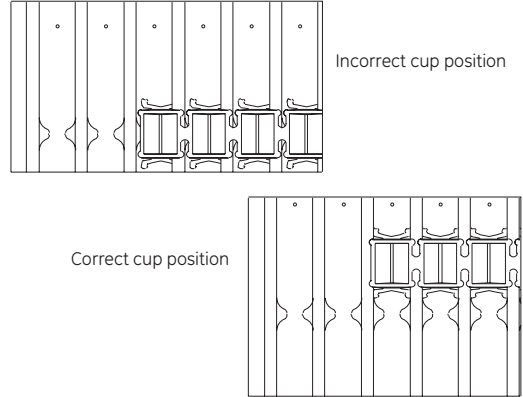

Fig 31. Sample cup positioning details.
Note: Cups must not straddle the centering protrusions on the bottom of the channels.

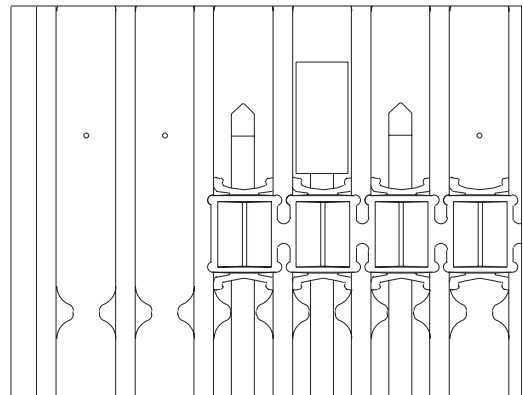

Fig 32. Correct placement of paper wicks.

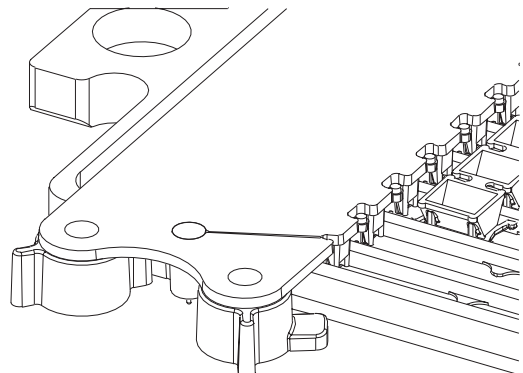



Fig 33. Placement of electrode on paper wicks. Cams are in the open position.

2.8 Isoelectric focusing guidelines— Ettan IPGphor 3 System

IEF using the Ettan IPGphor 3 Isoelectric Focusing System is conducted at very high voltages (up to 10 000 V, depending on the length of the DryStrip used) and very low currents (typically less than 50 μ A per Immobiline DryStrip gel) due to the low ionic strength within Immobiline DryStrip gels. During IEF, the current decreases while the voltage increases as proteins and other charged components migrate to their equilibrium positions. A typical IEF protocol generally proceeds through a series of voltage steps that begins at a relatively low value. Voltage is gradually increased to the final desired focusing voltage, which is held for several hours. A low initial voltage minimizes sample aggregation and allows the parallel separation of samples with differing salt concentrations. A gradual increase in voltage is particularly advisable for higher protein loads (100 μ g or more per Immobiline DryStrip gel).

Many factors affect the amount of time required for complete focusing, and each specific set of conditions (e.g. sample and rehydration solution composition, Immobiline DryStrip gel length, and pH gradient) requires empirical determination for optimal results. An approximate time for complete focusing is given in the example protocols provided in Table 19. Factors that increase the required focusing time include residual ions, which must move to the ends of the Immobiline DryStrip gels before protein focusing can occur, and the presence of IPG Buffers or Pharmalyte, which contributes to the ionic strength of the electrophoresis medium. A higher IPG Buffer concentration increases the conductivity of the Immobiline DryStrip gel, resulting in a lower final voltage when the system is limited by the maximum current setting.

 Longer focusing times may therefore be required at IPG Buffer/Pharmalyte concentrations higher than 0.5%.

 For higher protein loads (up to 1 mg or more) the final focusing step of each protocol can be extended if necessary by an additional 20% of the total recommended Volt-hour value.

 Exceeding the current limit of 50 μ A/Immobiline DryStrip gel is not recommended, as this may result in excessive heat generation and may damage the Immobiline DryStrip gel and/or Manifold or Strip Holder. Under extreme circumstances, the Immobiline DryStrip gel may burn.

 Overfocusing can sometimes occur on longer runs and may contribute to horizontal streaking, which will be visible in the 2-D gel result (see also chapter 7, Troubleshooting).

2.8.1 Protocol examples—Ettan IPGphor 3 Isoelectric Focusing System

These protocols are suitable for first-dimension isoelectric focusing of protein samples prepared in rehydration solution in typical analytical quantities (1–100 μ g).

The protocols are optimized for a rehydration solution containing 0.5% IPG Buffer or Pharmalyte. The recommended current limit is 50 μ A/Immobiline DryStrip gel. Recommended focusing times are given, but the optimal length of time will depend on the nature of the sample, the amount of protein, and the method of sample application.

Please refer to the Ettan IPGphor 3 user manual for instructions on how to program a protocol.

2.8.2 Running an Ettan IPGphor 3 protocol

Ensure that the Strip Holders are properly positioned on the Ettan IPGphor 3 platform. Use the guide marks along the sides of the platform to position each Strip Holder and check that the pointed end of the Strip Holder is over the anode (pointing to the back of the unit) and the blunt end is over the cathode. (Please refer to the Ettan IPGphor 3 user manual for complete details.) Check that both external electrode contacts on the underside of each Strip Holder make metal-to-metal contact with the platform.

Before closing the safety lid, insert the lid adaptor (an accessory included with IPGphor 3) such that the pressure pads press gently against the cover of each Strip Holder to ensure contact between the electrodes and the electrode areas. Begin IEF.

 As isoelectric focusing proceeds, the bromophenol blue tracking dye migrates toward the anode. Note that the dye front leaves the Immobiline DryStrip gel well before focusing is complete, so clearing of the dye is no indication that the sample is focused. If the dye does not migrate, no current is flowing. If this occurs, check the contact between the external face of the Strip Holder electrodes and the electrode areas on the instrument, and between the rehydrated gel and the internal face of the electrodes. Table 19 lists guidelines for running Immobiline DryStrip gels on Ettan IPGphor 3.

 It is possible that the programmed maximum voltage will not be reached when using shorter Immobiline DryStrip gels or with samples having high conductivity.

 The final step of focusing should be run in volt-hours to ensure reproducibility from run to run.

The following protocols are suitable for first-dimension isoelectric focusing of proteins run on Ettan IPGphor 3 Isoelectric Focusing Unit.

 Preparative sample loads often increase the electroosmotic pumping of water. Excess free water on the gel surface contributes to streaky results and should be absorbed with electrode pads. This technique is standard when using the Ettan IPGphor 3 Manifold; for standard Strip Holders this technique is described in section 2.7.

 The focusing times below are guidelines only, based on well-prepared samples. Times may vary with the nature of the sample and how the sample is applied. Using crude samples with high protein and salt content or using paper-bridge loading, the run time in total kiloVolt-hours should be increased by 10%.

 For Immobiline Dry Strip pH 6.2–7.5, 6–9, 6–11, and 7–11 NL, loading the sample anodically in a sample cup is recommended. For preparative sample loads with these basic strips, paper-bridge loading is recommended.

 If using the Manifold and 18- and 24-cm strips, the maximum voltage is 10 000 V. With these two strip lengths and standard Strip Holders, the maximum allowed voltage is 8000 V. With all other strips and regardless of whether the Manifold is being used, the maximum voltage is 8000 V.

Table 19. Guidelines for running 7–24-cm Immobiline DryStrip gels on Ettan IPGphor 3 Isoelectric Focusing Unit. Running conditions: Temperature 20 °C; current 50 µA per strip except where noted. See footnotes for information specific to the different strip lengths.

7-cm strips

pH intervals	Voltage mode	Voltage (V)	Time (h:min)	kVh
3–11 NL	1 Step and Hold	300	0:30	0.2
3–10	2 Gradient	1000	0:30	0.3
6–11	3 Gradient	5000	1:20	4.0
	4 Step and Hold	5000	0:06–0:25	0.5–2.0
	Total		2:26–2:45	5.0–6.5
3–10 NL	1 Step and Hold	300	0:30	0.2
4–7	2 Gradient	1000	0:30	0.3
3–5,6 NL	3 Gradient	5000	1:30	4.5
	4 Step and Hold	5000	0:12–0:36	1.0–3.0
	Total		2:42–3:06	6.0–8.0
7–11 NL	1 Step and Hold	300	0:30	0.2
	2 Gradient	1000	1:00	0.7
	3 Gradient	5000	1:30	4.5
	4 Step and Hold	5000	0:20–0:55	1.6–4.6
	Total		3:20–3:55	7.0–10.0
5.3–6.5	1 Step and Hold	300	1:00	0.2
6.2–7.5	2 Gradient	1000	1:00	0.7
	3 Gradient	5000	2:30	7.5
	4 Step and Hold	5000	0:45–1:30	3.6–7.6
	Total		5:15–6:00	12.0–16.0

Table 19. (continued)

11-cm strips

pH intervals	Step Voltage mode	Voltage (V)	Time (h:min)	kVh
3-11 NL	1 Step and Hold	500	1:00	0.5
3-10	2 Gradient	1000	1:00	0.8
6-11	3 Gradient	6000	2:00	7.0
	4 Step and Hold	6000	0:10-0:40	0.7-3.7
	Total		4:10-4:40	9.0-12.0
4-7	1 Step and Hold	500	1:00	0.5
3-5.6 NL	2 Gradient	1000	1:00	0.8
	3 Gradient	6000	2:30	8.8
	4 Step and Hold	6000	0:10-0:50	0.9-4.9
	Total		4:40-5:20	11.0-15.0
7-11 NL	1 Step and Hold	500	1:00	0.5
	2 Gradient	1000	1:00	0.8
	3 Gradient	6000	2:30	8.8
	4 Step and Hold	6000	0:50-1:40	4.9-9.9
	Total		5:20-6:10	15.0-20.0
5.3-6.5	1 Step and Hold*	500	1:00*	0.5
6.2-7.5	2 Gradient	1000	1:00	0.8
	3 Gradient	6000	3:00	10.5
	4 Step and Hold	6000	2:40-3:50	16.2-23.2
	Total		7:40-8:50	28.0-35.0

* To convert this to a convenient overnight run, extend Step 1 to 6 h (3 kVh) and reduce step 4 by 3 kVh.

13-cm strips

pH intervals	Step Voltage mode	Voltage (V)	Time (h:min)	kVh
3-10	1 Step and Hold	500	1:00	0.5
3-11 NL	2 Gradient	1000	1:00	0.8
6-11	3 Gradient	8000	2:30	11.3
	4 Step and Hold	8000	0:10-0:30	1.4-4.4
	Total		4:40-5:00	14.0-17.0
3-10 NL	1 Step and Hold	500	1:00	0.5
4-7	2 Gradient	1000	1:00	0.8
3-5.6 NL	3 Gradient	8000	2:30	11.3
	4 Step and Hold	8000	0:25-0:55	3.4-7.4
	Total		4:55-5:25	16.0-20.0
7-11 NL	1 Step and Hold	500	1:00	0.5
	2 Gradient	1000	1:00	0.8
	3 Gradient	8000	3:00	13.5
	4 Step and Hold	8000	0:45-1:15	6.2-10.2
	Total		5:45-6:15	21.0-25.0
5.3-6.5	1 Step and Hold*	500	1:00*	0.5
6.2-7.5	2 Gradient	1000	1:00	0.8
	3 Gradient	8000	3:00	13.5
	4 Step and Hold	8000	2:55-4:10	23.2-33.2
	Total		7:55-9:10*	38.0-48.0

* To convert this to a convenient overnight run, extend Step 1 to 6 h (3 kVh) and reduce step 4 by 3 kVh.

Table 19. (continued)

18-cm strips

Note: When using IPGphor Manifold and 10 kV, set current limit to 75 µA per strip and follow step 1, 2, 3b and 4b. Using IPGphor Regular Strip Holder or Cup Loading Strip Holder with the 18- and 24-cm strips, the maximum allowed voltage is 8000 V and current 50 µA per strip. Follow step: 1, 2, 3a, 4a.

pH intervals	Step Voltage mode	Voltage (V)	Time (h:min)	Volt-hours kWh
3-10	1 Step and Hold*	500	1:00 (8:00)*	0.5
3-11 NL	2 Gradient	1000	1:00	0.8
6-11	3a Gradient†	8000	3:00	13.5
	4a Step and Hold‡	8000	0:46-1:30	6.2-12.2
	3b Gradient‡	10000	3:00	16.5
	4b Step and Hold‡	10000	0:20-0:55	3.2-9.2
	Total			21.0-27.0
3-10 NL	1 Step and Hold‡	500	1:00 (8:00)*	0.5
4-7	2 Gradient	1000	1:00	0.8
3-5.6 NL	3a Gradient†	8000	3:00	13.5
	4a Step and Hold‡	8000	1:30-2:40	12.2-21.2
	3b Gradient‡	10000	3:00	16.5
	4b Step and Hold‡	10000	0:55-1:50	9.2-18.2
	Total			27.0-36.0
6-9	1 Step and Hold*	500	1:00 (8:00)*	0.5
7-11 NL	2 Gradient	1000	1:00	0.8
	3a Gradient†	8000	3:00	13.5
	4a Step and Hold‡	8000	3:10-4:30	25.2-35.2
	3b Gradient‡	10000	3:00	16.5
	4b Step and Hold‡	10000	2:15-3:15	22.2-32.2
	Total			40.0-50.0
5.3-6.5	1 Step and Hold*	500	2:00 (3:00)*	1.0
6.2-7.5	2 Gradient	1000	2:00	1.5
	3a Gradient†	8000	3:00	13.5
	4a Step and Hold‡	8000	6:45-8:40	54.0-69.0
	3b Gradient‡	10000	3:00	16.5
	4b Step and Hold‡	10000	5:05-6:35	51.0-66.0
	Total			70.0-85.0

* When a more convenient overnight run of 15 to 17 h is desired, the time in step 1 can be extended up to recommended value in brackets. Using this option, step 4 can be reduced with the added kWh in step 1, to reach the specified total kWh.

† Follow steps 1, 2, 3a and 4a when using IPGphor Regular Strip Holder or Cup Loading Strip Holder.

‡ Follow steps 1, 2, 3b and 4b when using IPGphor Cup Loading Manifold.

Table 19. (continued)

24-cm strips

Note: When using IPGphor Manifold and 10 kV, set current limit to 75 μ A per strip and follow step 1, 2, 3b and 4b. Using IPGphor Regular Strip Holder or Cup Loading Strip Holder with the 18- and 24-cm strips, the maximum allowed voltage is 8000 V and current 50 μ A per strip. Follow step: 1, 2, 3a, 4a.

pH intervals	Step Voltage mode	Voltage (V)	Time (h:min)	kVh
3–11 NL 3–10	1 Step and Hold*	500	1:00 (8:00)*	0.5
	2 Gradient	1000	1:00	0.8
	3a Gradient [†]	8000	3:00	13.5
	4a Step and Hold [‡]	8000	2:30–3:45	20.0–30.0
	3b Gradient [‡]	10000	3:00	16.5
	4b Step and Hold [‡]	10000	1:45–2:45	17.2–27.2
	Total			35.0–45.0
3–10 NL 3–7 NL 4–7 3–5,6 NL	1 Step and Hold*	500	1:00 (7:00)*	0.5
	2 Gradient	1000	1:00	0.8
	3a Gradient [†]	8000	3:00	13.5
	4a Step and Hold [‡]	8000	3:45–5:36	30.0–45.0
	3b Gradient [‡]	10000	3:00	16.5
	4b Step and Hold [‡]	10000	2:45–4:15	27.2–42.2
	Total			45.0–60.0
6–9 7–11 NL	1 Step and Hold*	500	1:00 (5:00)*	0.5
	2 Gradient	1000	1:00	0.8
	3a Gradient [†]	8000	3:00	13.5
	4a Step and Hold [‡]	8000	5:36–8:45	45.0–70.0
	3b Gradient [‡]	10000	3:00	16.5
	4b Step and Hold [‡]	10000	4:15–6:45	42.2–67.2
	Total			60.0–85.0
3.5–4.5	1 Step and Hold*	500	2:00 (5:00)*	1.0
	2 Gradient	1000	2:00	1.5
	3a Gradient [†]	8000	3:00	13.5
	4a Step and Hold [‡]	8000	9:10–10:30	74.0–84.0
	3b Gradient [‡]	10000	3:00	16.5
	4b Step and Hold [‡]	10000	7:05–8:05	71.0–81.0
	Total			90.0–100.0
5.3–6.5 6.2–7.5	1 Step and Hold*	500	2:00 (5:00)*	1.0
	2 Gradient	1000	2:00	1.5
	3a Gradient [†]	8000	3:00	13.5
	4a Step and Hold [‡]	8000	9:19–10:30	94.0–114.0
	3b Gradient [‡]	10000	3:00	16.5
	4b Step and Hold [‡]	10000	9:05–11:05	91.0–111.0
	Total			110.0–130.0

* When a more convenient overnight run of 15 to 17 h is desired, the time in step 1 can be prolonged to up to recommended values in brackets. Using this option, step 4 can be reduced with the added kVh in step 1, to reach the specified total kVh.

[†] Follow steps 1, 2, 3a and 4a when using IPGphor Regular Strip Holder or Cup Loading Strip Holder.

[‡] Follow steps 1, 2, 3b and 4b when using IPGphor Cup Loading Manifold.



If using regular Strip Holders, active rehydration can be performed (if sample is included) by adding an extra step at the beginning of the protocol (e.g. Voltage mode = 1 Step and Hold, Voltage = 30, Step duration = 10:00, kVolt-hours = 0.3 kVh).

2.8.3 Preservation of focused Immobiline DryStrip gels

After IEF is complete, proceed to the second-dimension separation immediately or store the Immobiline DryStrip gels at -60 °C or below. This can be conveniently done by placing the strips between plastic sheets, as suggested by Görg *et al.* (3) or on glass plates covered in plastic wrap. Alternatively, the DryStrip gels can be stored in screw-cap tubes. The 7-cm strips fit in disposable 15-ml conical tubes; 11-, 13-, and 18-cm strips fit in 25 × 200 mm screw cap culture tubes; and 18- and 24-cm strips fit in Equilibration Tubes (see ordering information). The equilibration process is discussed in chapter 3.

2.9 Troubleshooting



Table 20 lists possible problems that might be encountered during IEF and how to solve them, and Table 21 lists problems and solutions when using Ettan Manifold.

Table 20. Troubleshooting first-dimension IEF: Ettan IPGphor 3 Isoelectric Focusing System.

Symptom	Possible solutions
Problems indicated by LCD messages	
Lid open step 1, close to continue	The safety lid is not properly closed. When the safety lid is open, the system has an automatic voltage cutoff safety feature. In order for the protocol to proceed, the safety lid must be closed.
Locked screen in edit mode	Turn off the mains power switch to reset the instrument.
Blank display	If no electrical components are functioning (e.g. HV lamp does not light and the cooling fans are motionless), check the fuses in the mains power module.
Diagnostic program indicates component failure	Note the component that failed and press the START key to continue through the diagnostic program. Call your local GE Healthcare sales office for further information on how to remedy the failure.
Power delivery	
Current too low or zero	At least two of three pressure pads on the lid adaptor of IPGphor 3 under the safety lid should press gently against the strip holders to ensure electrical continuity between the strip holder electrodes and the electrode areas on the platform. The gel must be evenly and completely rehydrated to conduct current. Make sure the proper amount of rehydration solution is applied to the IPG strip holder and allow a minimum of 10 hours for rehydration.
Voltage limit not reached	The ionic strength of the rehydration solution is too high; reduce the IPG buffer concentration; use a mixed-bed ion-exchange resin to remove ionic breakdown products of urea or other additives. Desalt the sample or prepare the sample so that the salt concentration is less than 10 mM.
Sparks or burning in strips	Reduce the current limit. Do not exceed 50 μ A per strip. Prevent the IPG strip from drying out by always applying Immobiline DryStrip Cover Fluid immediately after strip placement in rehydration buffer. Ensure that the IPG strip is fully rehydrated along the entire length of the strip. The IPG strip should be in complete contact with the correct volume of rehydration solution. Remove any air bubbles trapped under the IPG strip. Desalt the sample or prepare the sample so that the salt concentration is less than 10 mM. De-ionize additives to the rehydration solution. Excessive charged material in the sample or rehydration buffer can lead to electroendosmosis, which could dry out part of the strip, possibly leading to arcing and burning in this region.

Table 21. Troubleshooting first-dimension IEF: Employing the Manifold.

Symptom	Possible cause	Remedy
Current is too low or zero	Electrical continuity is impeded.	<p>Check the external electrode contacts: Ensure correct placement of the electrode assemblies such that there is metal-to-metal contact with the appropriate electrode contact area.</p> <p>Check the internal electrode contacts: The gel (which becomes visible because of the dye in the rehydration solution) must contact both electrodes in the Manifold through the paper wicks and/or paper bridge parts.</p> <p>Check that the IPG strip is fully rehydrated along its entire length. Electrical contact at the electrodes is reduced by incomplete rehydration.</p> <p>Check that the paper wicks are present and properly positioned.</p>
Voltage too low or does not reach maximum set value	Ettan IPGphor protocol settings are incorrect for the experiment.	<p>Check that the current limit is properly set.</p> <p>Check that the actual number of Immobililine DryStrip gels on the Ettan IPGphor platform is the same as the number of gels entered in the protocol.</p>
	Conductivity/ionic strength is too high.	<p>Prepare the sample to yield a salt concentration less than 10 mM. The recommended IPG Buffer concentration is 0.5%. A maximum of 2% is advisable only if sample solubility is a problem. High conductivity can also arise from the use of poor quality urea or other denaturants. Urea is also prone to decomposing to charged breakdown products. Higher conductivity salts and ionic impurities in the sample can raise the conductivity of the strip.</p> <p>Shorter length IPG strips (e.g. 7 cm strips) will not reach 8000 V. The distance between the electrodes is shorter so that the voltage gradient (V/cm) required to reach the 50 μA current limit is reached at a lower overall voltage.</p>
Sample leaks from cup	Incorrect cup placement.	<p>Check that the feet of the cups are resting on the bottom of the manifold channel.</p> <p>Check for correct positioning of sample cup arms.</p> <p>Check that the feet of the cups are not resting on a centering protrusion in the channel.</p>
	Incorrect strip placement.	Check that the strip is centered inside of the channel.
Sparkling or burning in the Immobililine DryStrip gels	Current limit setting is too high.	Do not exceed the maximum recommended setting of 50 μ A per Immobililine DryStrip gel.
	Immobililine DryStrip gel is not fully rehydrated.	Ensure that the Immobililine DryStrip gels are rehydrated with a sufficient volume of rehydration solution. Remove any large bubbles trapped under the Immobililine DryStrip gel after placing it on rehydration solution.
	Immobililine DryStrip gels dried out during IEF.	Always apply Immobililine DryStrip Cover Fluid to prevent dehydration of rehydrated Immobililine DryStrip gels.
Immobililine DryStrips turn white and opaque after focusing	Immobililine DryStrip gels dried out during IEF.	Always apply recommended amount of Immobililine DryStrip Cover Fluid to prevent dehydration of rehydrated Immobililine DryStrip gels.
Immobililine DryStrip Cover Fluid overflows from Manifold	Excess cover fluid added.	Do not add more than the recommended volume. Ensure that the outside rim of the tray does not have any oil on it.

3. Second-dimension SDS-PAGE using vertical electrophoresis systems

3.0 Overview

After IEF, the second-dimension SDS-polyacrylamide gel electrophoresis (SDS-PAGE) can be performed on various vertical or flatbed systems, depending on factors such as those discussed in “Equipment Choices” on pages 14–16. SDS-PAGE consists of four steps:

- 1) Preparing the system for second-dimension electrophoresis
- 2) Equilibrating the Immobiline DryStrip gel(s) in SDS equilibration buffer
- 3) Placing the equilibrated Immobiline DryStrip gel on the SDS gel
- 4) Electrophoresis

The equilibration step is described first because it is a protocol common to all electrophoresis systems described in this handbook. Gel preparation, Immobiline DryStrip gel placement, and electrophoresis protocols, on the other hand, are specific to the orientation of the gel. Sections 3.3 and 3.4 describe these protocols as they apply to vertical systems; sections 4.1 and 4.2 describe them as they apply to the flatbed Multiphor II Electrophoresis System.

3.1 Equilibrating Immobiline DryStrip gels



As mentioned in chapter 2, after IEF it is important to proceed immediately to gel equilibration, unless the IPG strip is being frozen (at -60 °C or below) for future analysis. Equilibration is always performed immediately prior to the second-dimension run, never before storage of the Immobiline DryStrip gels.

The second-dimension gel itself should be prepared and ready to accept the Immobiline DryStrip gel before beginning the equilibration protocol.

3.1.1 Equilibration solution components

The equilibration step saturates the Immobiline DryStrip gel with the SDS buffer system required for the second-dimension separation. The equilibration solution contains buffer, urea, glycerol, reductant, SDS, and dye. An additional equilibration step replaces the reductant with iodoacetamide.

Equilibration buffer (75 mM Tris-HCl, pH 8.8) maintains the Immobiline DryStrip gel in a pH range appropriate for electrophoresis.

Urea (6 M) together with glycerol reduces the effects of electroendosmosis by increasing the viscosity of the buffer (3). Electroendosmosis is due to the presence of fixed charges on the Immobiline DryStrip gel in the electric field and can interfere with protein transfer from the Immobiline DryStrip gel to the second-dimension gel.

Glycerol (30%) together with urea reduces electroendosmosis and improves transfer of proteins from the first to the second dimension (3).

Dithiothreitol (DTT) preserves the fully reduced state of denatured, unalkylated proteins.

Sodium dodecyl sulfate (SDS) denatures proteins and forms negatively charged protein-SDS complexes (see section 3.2).

Iodoacetamide alkylates thiol groups on proteins, preventing their reoxidation during electrophoresis. Protein reoxidation during electrophoresis can result in streaking and other artifacts. Iodoacetamide also alkylates residual DTT to prevent point streaking and other silver-staining artifacts (80). Iodoacetamide is introduced in a second equilibration step. The second equilibration with iodoacetamide minimizes unwanted reactions of cysteine residues (i.e. when mass spectrometry is to be performed on the separated proteins).

Tracking dye (bromophenol blue) allows monitoring of the progress of electrophoresis.

3.1.2 Equilibrating Immobiline DryStrip gels



The second-dimension vertical gel must be ready for use prior to Immobiline DryStrip gel equilibration. If not using the DryStrip gel immediately, refer to section 2.8.3 for preservation guidelines.

Protocol

Equilibration is carried out in a two-step process using tubes and volume of equilibration solution as specified in Table 22.

Preparatory steps

1. Place the IPG strips in individual tubes, with the support film toward the tube wall.
2. Prepare an appropriate volume of SDS equilibration buffer solution (see appendix I, solution E) then measure into two equal volumes. Add DTT to one portion (100 mg per 10 ml) and iodoacetamide to the other (250 mg per 10 ml).

Equilibration

1. Add the appropriate volume of SDS equilibration buffer (+ DTT) to each strip. Cap or seal the tubes with flexible paraffin film and place them on their sides on a rocker for the equilibration process. Equilibrate for 15 min.
2. Pour off buffer from above step and add the appropriate volume of SDS equilibration buffer (+iodoacetamide) to each strip. Again cap or seal the tubes with flexible paraffin film and place them on their sides on a rocker for the equilibration process. Equilibrate for an additional 15 min.



Be consistent with the timing of the equilibration steps.

Table 22. Suggested containers and volumes of equilibration solution.

Strip length (cm)	Container	Equilibration solution (ml)
7	Disposable, 15-ml conical tubes	2.5–5
11	25 × 200 mm screw-cap culture tubes	5–10
13	25 × 200 mm screw-cap culture tubes	5–10
18	25 × 200 mm screw-cap culture tubes, Equilibration tubes available from GE Healthcare, or Petri dish	10–15
24	Equilibration tubes available from GE Healthcare or Petri dish	10–15



The subsequent steps of gel assembly, preparation of electrophoresis unit, insertion of the gel into the precast gel cassette, and melting of the sealing solution can be performed as the Immobiline DryStrip gels are equilibrating, as long as the timeframes above are adhered to.

3.2 Background to SDS-PAGE

SDS-PAGE is an electrophoretic method for separating polypeptides according to their molecular weights (M_r). The technique is performed in polyacrylamide gels containing sodium dodecyl sulfate (SDS). The intrinsic electrical charge of the sample proteins is not a factor in the separation due to the presence of SDS in the sample and the gel. SDS is an anionic detergent that, when in solution in water, forms globular micelles composed of 70–80 molecules with the dodecyl hydrocarbon moiety in the core and the sulfate head groups in the hydrophilic shell. SDS and proteins form complexes with a necklace-like structure composed of protein-decorated micelles connected by short flexible polypeptide segments (77). The result of the necklace structure is that large amounts of SDS are incorporated in the SDS-protein complex in a ratio of approximately 1.4 g SDS/g protein. SDS masks the charge of the proteins themselves and the formed anionic complexes have a roughly constant net negative charge per unit mass. Besides SDS, a reducing agent such as DTT is also added to break any disulfide bonds present in the proteins. When proteins are treated with both SDS and a reducing agent, the degree of electrophoretic separation within a polyacrylamide gel depends largely on the molecular weight of the protein. In fact, there is an approximately linear relationship between the logarithm of the molecular weight and the relative distance of migration of the SDS-polypeptide complex. (Note: This linear relationship is only valid for a certain molecular weight range, which is determined by the polyacrylamide percentage. See Table 24 for the optimum linear separation range for single percentage [homogeneous] and gradient gels.)

The most commonly used buffer system for second-dimension SDS-PAGE is the Tris-glycine system described by Laemmli (78). This buffer system separates proteins at high pH, which confers the advantage of minimal protein aggregation and clean separation even at relatively heavy protein loads. The Laemmli buffer system has the disadvantage of a limited gel shelflife.

Ettan DALT precast gels utilize a buffer system based on piperidinopropionamide (PPA), which combines long shelflife with the high separation pH of the Laemmli system. Other buffer systems can also be used, particularly the Tris-tricine system of Schagger and von Jagow (79) for improving resolution of polypeptides with M_r values below 10 000. ExcelGel precast gels for second-dimension SDS-PAGE on the Multiphor II Electrophoresis System (see chapter 4) utilize a different Tris-tricine buffer system.

3.3 Electrophoresis using Ettan DALT Large Vertical electrophoresis systems

Ettan DALTsix and DALTwelve Large Vertical electrophoresis systems combined with 24-cm-long Immobiline DryStrip gels offer the highest possible 2-D resolution. Both systems are designed for simplified assembly and rapid electrophoresis of the second-dimension gel. Ettan DALTsix system accepts up to six large, second-dimension gels (26 × 20 cm) (Fig 2 on page 11). Ettan DALTwelve system can handle up to 12 large gels (Fig 3 on page 12). When running fewer gels, unused slots are filled with blank cassette inserts. Safety interlocks prevent the application of power to the separation unit unless the lid is properly closed. Both units recirculate the buffer so that even gel temperatures are maintained during electrophoresis.

Most of the steps are common between Ettan DALTsix and Ettan DALTwelve systems, and thus the protocols presented below apply to both. Where there are differences (in two instances —preparing the system for electrophoresis and inserting gels into the system), alternate protocols are presented under the same section number.

Power supply and temperature control unit

The modular Ettan DALTsix system requires an external power supply and thermostatic circulator to control the buffer temperature. A power supply capable of 100 W constant power output, such as the EPS 601, is recommended for the fastest separation time. For temperature control, a circulating water bath such as the MultiTemp III should be used. The operating temperature range of Ettan DALTsix system is 4–40 °C.

Ettan DALTwelve system is controlled from the Power Supply/Control Unit. The unit supplies a maximum power output of 200 W with a maximum of 600 V or 1 A. The power supply unit also controls the temperature of the tank using Peltier elements. The operating temperature range of Ettan DALTwelve system is 10–50 °C.

Gel caster

Both Ettan DALTsix and Ettan DALTwelve systems include gel casters to prepare lab-cast gels. Separator sheets are sandwiched between the gel-casting cassettes for easy removal from the caster following gel polymerization. Removable front plates allow for simplified loading and removal of the gel cassettes.

DALTsix Gel Caster accommodates either six 1.0-mm or six 1.5-mm gel cassettes with separator sheets. Fewer gels can be cast by inserting blank cassettes to minimize the volume of casting solution.

DALTwelve Gel Caster allows fourteen 1-mm-thick gels and thirteen 1.5-mm-thick gels to be cast at one time. Fewer gels can be cast by inserting blank cassettes to occupy volume not required. The caster has a unique hydrostatic chamber to add a displacement solution allowing for volume changes of the solution during polymerization and to produce multiple gels cast to the same height.

Gradient maker

DALTsix Gradient Maker is used in combination with DALTsix Gel Caster for 1-mm-thick and 1.5-mm-thick gels, and with DALTwelve Gel Caster for 1-mm-thick gels. It is designed to produce linear gradients of solutions in the volume range 200–1000 ml. The gradient maker can be used to form convex or concave exponential gradients by the addition of a one-holed rubber stopper, a piece of rigid tubing, and a piece of flexible tubing. Refer to the Ettan DALTsix user manual for more information.

DALT gel casting cassettes

DALT gel casting cassettes fit either Ettan DALTsix or Ettan DALTwelve electrophoresis units. In the standard hinged cassette, one tall and one short glass plate are hinged together with vinyl spacers glued in place. The simplified design of the cassette allows for easy assembly, and no clamps are required to seal the cassette.

Standard glass plate sets and low-fluorescent glass plate sets are available for use with Ettan DALT systems. Vinyl spacers are glued into place as with the standard cassette. The plates are not hinged, which means that a single glass plate is able to fit into the spot picker when the gel is chemically bound to the plate using Bind-Silane (see appendix V).

DALT Gel 12.5 and DALT Precast Gel Cassette

DALT Gel 12.5 is a precast polyacrylamide gel (25.5 × 19.6 cm, 1 mm thick) for the second dimension of 2-D electrophoresis. The gel is provided already cast onto a plastic support film. The gel is a homogeneous 12.5% polyacrylamide gel. It is intended to be used in Ettan DALTsix or Ettan DALTwelve system together with the DALT Buffer Kit. The gel is formulated for long shelflife and, when used with the buffer kit, generates a discontinuous buffer system yielding rapid runs with sharp, reproducible results. The gels are inserted into a specially designed reusable cassette and run vertically in the Ettan DALT systems.



If fluorescent staining/labeling techniques will be used, do not run gels cast on plastic backing, as it can pose a problem of high background with some dyes during subsequent analysis.

3.3.1 Preparing Ettan DALT system for electrophoresis using precast gels

Protocols for use of Ettan DALTsix and Ettan DALTwelve differ in two main areas: preparing the system and inserting the gel into the unit. Thus, where appropriate, separate protocols are provided for the different systems. The first instance follows.

Protocol: Preparing Ettan DALTsix

For detailed instructions for using Ettan DALTsix system, please refer to the Ettan DALTsix user manual.

Preliminary steps



Place the unit close to a sink for easy rinsing and draining. Connect the tubing leading to and from the heat exchanger to a thermostatic temperature controller such as MultiTemp III. Do not connect the heat exchanger to a water tap or any other coolant supply that does not have pressure regulation. Position an EPS 601 Power Supply conveniently close to the electrophoresis unit.

- 1. Prepare anode and cathode buffers (stocks included in the DALT Buffer Kit)**
Dilute half of the 100× anode (lower) buffer by adding 37.5 ml to 4.5 l of water.
Dilute one bottle of 10× cathode (upper) buffer to 2× buffer to a final volume of 1.2 l with deionized water.
- 2. Prepare anode assembly**
Insert the anode assembly/cassette carrier into the tank. The anode assembly is molded so that it can only be inserted in one orientation. The side edge of the assembly should fit into the slot in the side of the tank.
- 3. Fill with anode buffer**
Pour the diluted anode buffer into the tank of the Ettan DALTsix Electrophoresis System (Fig 34). Switch on the pump.
- 4. Switch on the temperature controller**
Switch on the MultiTemp III temperature controller and adjust the temperature to the desired setting. A temperature of 25 °C is recommended for electrophoresis.
- 5. Set aside upper chamber**
The upper chamber is prepared once the gel has been inserted into Ettan Daltsix. See section 3.3.5.



Fig 34. Filling the Ettan DALTsix electrophoresis unit with anode buffer.

Protocol: Preparing Ettan DALTwelve

For detailed instructions for using Ettan DALTwelve system, please refer to the Ettan DALTwelve user manual.

1. Prepare cathode buffer

Dilute the cathode buffer included in the DALT Buffer Kit to working strength by adding both bottles of 10× cathode buffer (total volume 250 ml) to 2.25 l distilled or deionized water.

2. Prepare anode buffer

Ensuring that the valve on the separation unit is set to “circulate”, fill the tank to the 7.5 l fill line with distilled or deionized water. Add the entire contents (75 ml) of the 100× anode buffer included in the DALT Buffer Kit into the tank.



Avoid pouring the 100× anode buffer on the tubing by spreading the tubing slightly with one hand while pouring the solution with the other (Fig 35).

3. Switch on the separation unit

4. Turn on the pump to mix the buffers and set the separation unit to desired temperature



A temperature of 25 °C is recommended for electrophoresis.



Fig 35. Spreading the tubing elements apart with one hand while pouring the solution with the other (to avoid pouring the 100× anode buffer onto the tubing).

3.3.2 Inserting DALT Gel 12.5 into DALT Precast Gel Cassette

Protocol

1. Open the gel package

Cut around the package on two sides at approximately 1 cm from the edge to avoid cutting the gel or the support film. Remove the gel from the package. The gel is cast onto a plastic support film and does not cover the film entirely. The gel is covered with a protective plastic sheet. Markings on the protective sheet indicate the orientation of the gel and the direction of electrophoresis. The bottom (+ or anodic) edge of the gel is flush with the edge of the support film. The support film protrudes approximately 15 mm beyond the top (- or cathodic) edge of the gel and approximately 5 mm at either side.

2. Open DALT Precast Gel Cassette

Place the gel cassette on the bench top with the hinge down. Apply 1 ml gel buffer onto the glass plate as a streak along the spacer on the right edge of the glass plate (Fig 36). Add an additional 2 ml of gel buffer to the center of the plate.

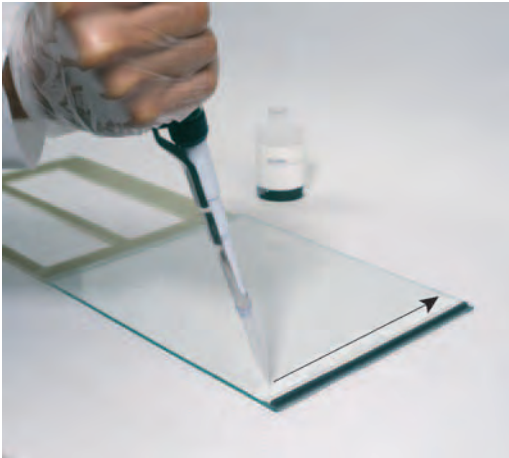

Fig 36. Pipetting a streak of gel buffer onto the glass plate. The arrow indicates the direction of motion in applying the streak.

3. Remove the protective plastic sheet from the gel

Handling the gel only by the side support film margins, hold it (gel-side down) over the glass plate. Ensure that it is oriented with the cathodic (-) edge of the gel toward the cathodic (-) edge of the cassette. Align the right edge of the gel with the right edge of the side spacer of the glass plate side, flex the gel downward slightly and lower it slowly toward the glass plate from right to left. Take care that the bottom (anodic) edge of the gel is flush (within 1 mm) of the bottom (anodic) edge of the glass plate. The protruding side support film margins (but not the gel) should rest on top of the side spacers.

4. Remove bubbles and excess buffer

Use the roller (a separate accessory) to press out any bubbles or liquid from between the gel and the glass. Press firmly against the plastic support film with the roller and roll over the entire gel (Fig 37). After rolling, the gel should adhere firmly to the glass and resist further movement.

5. Close the cassette

Close the cassette, snap the plastic frame to the glass plate (Fig 38) and press the edges tightly together along the entire side of the cassette. Ensure that the cassette is closed completely; an incompletely closed cassette causes a strongly curved front.

6. Repeat the procedure for each second-dimension gel to be run



Fig 37. Pressing out air pockets between gel and glass plate.



Fig 38. Closing the DALT Precast Gel Cassette.

3.3.3 Equilibrating Immobiline DryStrip gels

Refer to section 3.1.2. The equilibration procedure is the same whether applying the strip to precast or lab-cast gels.

3.3.4 Applying equilibrated Immobiline DryStrip gels to SDS gels

Both types of DALT gel cassettes (those for precast and for lab-cast gels) have a “longer” glass plate. The cassette should be laid on the bench with the longer glass plate down, and the protruding edge oriented toward the operator (Fig 39).

Protocol

1. Position the Immobiline DryStrip gel

Dip the equilibrated Immobiline DryStrip gel (see section 3.1.2) in the SDS electrophoresis buffer (see appendix I, solution M) to lubricate it. If using the DALT Gel 12.5, the diluted cathode buffer can be used to lubricate the strip.

Place the strip with the acidic end to the left, gel surface up onto the protruding edge of the longer glass plate (Fig 39).

If using a system other than DALTtwelve or DALTsix, position the Immobiline DryStrip gel between the plates on the surface of the second-dimension gel with the plastic backing against one of the glass plates.

2. Ensure Immobiline DryStrip gel has good contact

With a thin plastic ruler, gently push the Immobiline DryStrip gel down so that the entire lower edge of the Immobiline DryStrip gel is in contact with the top surface of the slab gel (Fig 40). Ensure that no air bubbles are trapped between the Immobiline DryStrip gel and the slab gel surface or between the gel backing and the glass plate.

3. Optional: Apply molecular weight marker proteins

Best results are obtained when the molecular weight marker protein solution is mixed with an equal volume of a hot 1% agarose solution prior to application to the IEF sample application piece. The resultant 0.5% agarose will gel and prevent the marker proteins from diffusing laterally prior to the application of electric current.

Other alternatives are to apply the markers to a paper IEF sample application piece in a volume of 15–20 μ l.

For less volume, cut the sample application piece proportionally. Place the IEF application piece on a glass plate and pipette the marker solution onto it, then pick up the application piece with forceps and apply to the top surface of the gel next to one end of the Immobiline DryStrip gel. The markers should contain 200–1000 ng of each component for Coomassie staining and approximately 10–50 ng of each component for silver staining.

4. Seal the Immobiline DryStrip gel in place

The agarose sealing solution prevents the Immobiline DryStrip gel from moving or floating in the electrophoresis buffer.

For precast DALT gels, the agarose blocks the narrow gap(s) between the gel edge(s) and the lateral spacer(s) to prevent leakage of the upper buffer.

Prepare agarose sealing solution for DALT precast gels using the agarose sealing solution from the DALT Buffer Kit. If using the Laemmli buffer system, see appendix I, solution N.

Melt each aliquot as needed in a 100 °C heat block (each gel will require 1–1.5 ml). It takes approximately 10 min to fully melt the agarose.



An ideal time to carry out this step is during Immobiline DryStrip gel equilibration.

Allow the agarose to cool until the tube can be held with your fingers (60 °C) and then slowly pipette the amount required to seal the Immobiline DryStrip gel in place (Fig 41). Pipette slowly to avoid introducing bubbles. Apply only the minimum quantity of agarose sealing solution required to cover the Immobiline DryStrip gel. Allow a minimum of 1 min for the agarose to cool and solidify.

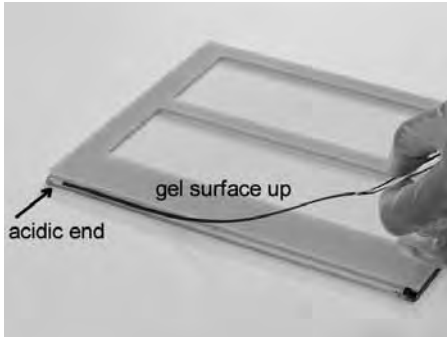

Fig 39. Positioning an equilibrated Immobiline DryStrip gel on the DALT Precast Gel Cassette.



Fig 40. Pushing the Immobiline DryStrip gel down to contact the gel slab.

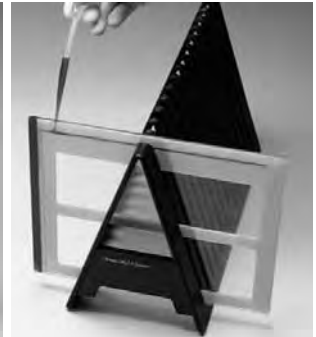

Fig 41. Sealing the Immobiline DryStrip gel in place on a DALT precast gel using agarose sealing solution.

3.3.5 Inserting gels into Ettan DALT electrophoresis units

Two protocols follow, the first for inserting gels into Ettan DALTsix and the second for inserting gels into Ettan DALTtwelve.

Protocol: Inserting gels into Ettan DALTsix

When the electrophoresis buffer has reached the desired temperature, insert the loaded gel cassettes with the Immobiline DryStrip gels in place.

1. Insert the cassettes into the cassette carrier (Fig 42) and fill any empty slots with blanks.
2. When all six slots are occupied, adjust the buffer level with distilled water so that the level of the diluted anode buffer is at the "LBC start fill" line marked on the unit.
3. Seat the upper buffer chamber over the gels (Fig 43).



Lubricate the gasket and cassette with cathodic buffer (e.g. SDS running buffer) to assist in assembly.

4. Fill the UBC with 1.2 l of 2x buffer. (if not already done in the protocol in section 3.3.1).
5. Using a small funnel, quickly fill the narrow space between the upper and lower buffer chambers with anode buffer or distilled water to the same level as in the upper buffer chamber.



It is important that the anode and cathode buffers are filled to the same height in the Ettan DALTsix buffer chambers.

6. Attach and close the lid. Connect the power leads to the power supply.



Fig 42. Inserting the cassettes into the cassette carrier.

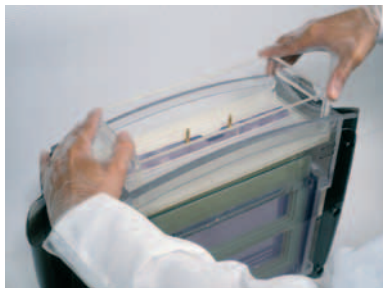

Fig 43. Seating the upper buffer chamber.

Protocol: Inserting gels into Ettan DALTwelve

When the electrophoresis buffer has reached the desired temperature, insert the loaded gel cassettes with the Immobiline DryStrip gels in place.

Gel Cassettes and Blank Cassette Inserts slide much more easily into the unit if they are wet. Distilled or deionized water from a squirt bottle can be used to wet the cassettes and Blank Cassette Inserts as they are being loaded into the unit.

1. Load the unit from back to front (Fig 44).
2. Fit Blank Cassette Inserts into any unoccupied slots.
3. When all 12 slots are occupied, the lower buffer level should be slightly below the level of the gaskets. Pour the diluted (1×) cathode buffer into the upper portion of the tank to the fill line (some of this buffer may drip through the gasket and mix with the anode buffer during the run, but this will not affect performance or results).
4. Close the lid.

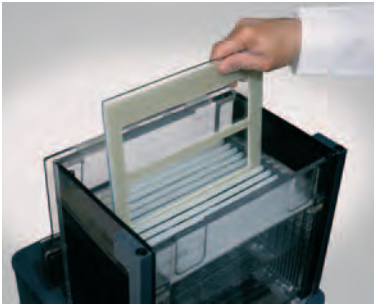

Fig 44. Loading the gel cassettes into Ettan DALTwelve electrophoresis unit.

3.3.6 Electrophoresis conditions with precast gels for both Ettan DALTsix and Ettan DALTwelve

Table 23 lists the recommended conditions for Ettan DALTsix and Ettan DALTwelve systems. Electrophoresis is performed at constant power in two steps. Stop electrophoresis when the dye front is approximately 1 mm from the bottom of the gel.

Temperature control improves gel-to-gel reproducibility, especially if the ambient temperature of the laboratory fluctuates significantly.

For best results, gels should be run at 25 °C.

After electrophoresis, remove gels from their gel cassettes in preparation for staining or blotting. Precast gels have a barcode, number, and gel percentage printed on them, which should be noted for orientation.

Table 23. Recommended electrophoresis conditions for second-dimension vertical gels.

	Step	Power (W/gel)	Approximate run duration (h:min)
Ettan DALTsix (set temperature to 25 °C)			
1-mm-thick gels (lab-cast and precast)	1	2	0:45
	2	17 (max 100)	4:00
1.5-mm-thick gels	1	5	0:30
	2	17 (max 100)	5:00
Ettan DALTwelve (set temperature to 25 °C)			
1-mm-thick gels (lab-cast and precast)	1	2	0:45
	2	17 (max 180)	4:00
1.5-mm-thick gels	1	5	0:30
	2	17 (max 180)	6:00
Overnight runs in Ettan DALTsix (set temperature to 30 °C, power supply for continuous run)			
1.0-mm-thick gels run overnight*		1	16:00
1.5-mm-thick gels run overnight*		1.5	18:30
Overnight runs in Ettan DALTwelve (set temperature to 30 °C, power supply for continuous run)			
1.0-mm-thick gels run overnight*		1	18:00
1.5-mm-thick gels run overnight*		1.5	17:00

* For the best possible resolution, faster separation times should be used. Use the faster (< 6 h) protocols instead.

3.3.7 Preparing lab-cast gels



Some of the chemicals used in the procedures that follow—acrylamide, N,N'-methylenebisacrylamide, ammonium persulfate, TEMED, thiourea, DTT, and iodoacetamide—are very hazardous. Acrylamide monomer, for example, is a neurotoxin and suspected carcinogen. Read the manufacturer's safety data sheet (MSDS) detailing the properties and precautions for all chemicals in your laboratory. These safety data sheets should be reviewed prior to starting the procedures described in this handbook. General handling procedures for hazardous chemicals include using double latex gloves for all protocols. Hazardous materials should be weighed in a fume hood while wearing a disposable dust mask. Follow all local safety rules and regulations, including for disposal.

Quick guide for finding information on gel casting for DALTsix and DALTwelve electrophoresis systems

To find gel-casting information quickly, refer to Table 25 for gel volumes required, Table 26 for single percentage gel recipes, and Table 27 for gradient gel recipes.

The instructions provided below for the preparation of vertical SDS-polyacrylamide gels employ the Tris-glycine system of Laemmli (78). Vertical second-dimension gels are most conveniently cast several at a time, in a multiple gel caster (see ordering information). For assembly of the gel cassette, refer to the relevant user manual.

Protocol

1. Select the gel percentage

a. Single percentage gel versus gradient gel. When a gradient gel is used, the overall separation interval is wider and the linear separation interval is larger. In addition, sharper bands result because the decreasing pore size functions to minimize diffusion. However, a gradient gel requires more skill to cast. For detailed instructions on gradient preparation, see the user manual for the relevant electrophoresis unit and multiple gel caster.

Single percentage gels offer better resolution for a particular M_r window. A commonly used second-dimension gel for 2-D electrophoresis is a homogeneous gel containing 12.5% total acrylamide.

Note: Stacking gels are not necessary for vertical 2-D gels.

b. Whether single percentage or gradient, the appropriate percentage gel is selected according to the range of separation desired (Table 24).

Table 24. Recommended acrylamide concentrations for protein separation.

Acrylamide percentage in resolving gel		Separation size range ($M_r \times 10^{-3}$)
Single percentage	5	36–200
	7.5	24–200
	10	14–200
	12.5	14–100*
	15	14–60*
Gradient	5–15	14–200
	5–20	10–200
	10–20	10–150

* Larger proteins fail to move significantly into the gel.

2. Select gel thickness and calculate casting solution volume

DALT gel casting cassettes with either 1.0- or 1.5-mm-thick spacers can be used. Thinner gels stain and destain more quickly and generally give less background staining. Thicker gels have a higher protein capacity. Thicker gels are also less fragile and easier to handle.

Table 25 gives the volumes required for Ettan DALT systems.

Table 25. Volumes required per cast (Ettan DALT systems).

Casting system	Volume (ml)
Ettan DALTsix	
6 gels × 1-mm-thick spacers	450
6 gels × 1.5-mm-thick spacers	600
Ettan DALTtwelve	
14 gels × 1-mm-thick spacers	900
13 gels × 1.5-mm-thick spacers	1200

3. Calculate the formulation of the gel solution

The recipes given in Table 26 produce 900 ml of solution for a single percentage gel. The recipes in Table 27 produce 450 ml each of light and heavy solution for a gradient gel. These recipes can be scaled up or down, depending on the volume required.

4. Prepare the gel solution

Make up the gel solution without TEMED or ammonium persulfate.

Note: An optional deaeration step may be performed at this point. To do so, make up the solution in a vacuum flask. Add a small magnetic stirring bar. Stopper the flask and apply a vacuum for several minutes while stirring on a magnetic stirrer.

Just before casting the gel, add TEMED and 10% ammonium persulfate. Gently swirl the flask to mix, being careful not to generate bubbles. Immediately pour the gel.

5. Pour and prepare the gel

Fill the gel cassette to 5–10 mm below the top (no stacking gel layer is required).

Overlay each gel with a layer of water-saturated 1-butanol (1.0 ml) immediately after pouring to minimize gel exposure to oxygen and to create a flat gel surface.

After allowing a minimum of 2 h for polymerization, remove the overlay and rinse the gel surface with gel storage solution (see appendix I, solution L).



An alternative to using water-saturated 1-butanol to overlay the gels after casting is to spray the edges of the cassettes using a 0.1% (w/v) SDS/water solution (using a plant sprayer) such that the edges are covered by just a few millimeters. This technique helps to avoid curved edges on the gels.

6. Storage of unused gels

Gels not used immediately can be stored for future use at 4 °C for up to two weeks. Gel storage solution (see appendix I, solution L) is pipetted over the top gel surface and the gel cassette is sealed with flexible paraffin film. Alternatively, the gel cassettes can be stored fully immersed in gel storage solution.

For further information on the preparation of second-dimension vertical SDS slab gels, refer to the user manuals for the respective vertical gel unit and multiple gel caster.

Table 26. Single-percentage gel recipes for Ettan DALT systems.*

Final gel concentration	10%	12.5%	15%
Monomer solution (solution G)	300 ml	375 ml	450 ml
4× resolving gel buffer (solution H)	225 ml	225 ml	225 ml
10% SDS (solution J)	9 ml	9 ml	9 ml
Double-distilled water	360.7 ml	285.7 ml	210.8 ml
10% ammonium persulfate [†] (solution K)	5 ml	5 ml	5 ml
TEMED [†]	0.30 ml	0.25 ml	0.20 ml
Total volume	900 ml	900 ml	900 ml

* Preparation of stock solutions is described in appendix I, solutions G, H, J, and K. Adjust as necessary for the thickness of the gels and the number of gels cast.

[†] Add after (optional) deaeration.

Table 27. Recipes for gradient gels for Ettan DALT systems.*

Light solution – Final concentration	8%	10%	12%	14%	16%
Monomer solution (solution G)	120 ml	150 ml	180 ml	210 ml	240 ml
4× resolving gel buffer (solution H)	113 ml	113 ml	113 ml	113 ml	113 ml
10% SDS (solution J)	4.5 ml	4.5 ml	4.5 ml	4.5 ml	4.5 ml
Double-distilled water	210.5 ml	180.5 ml	150.5 ml	120.5 ml	90.5 ml
10% ammonium persulfate [†] (solution K)	1.8 ml	1.8 ml	1.8 ml	1.8 ml	1.8 ml
TEMED [†]	0.225 ml	0.225 ml	0.225 ml	0.225 ml	0.225 ml
Total volume	450 ml	450 ml	450 ml	450 ml	450 ml
Heavy solution – Final concentration	12%	14%	16%	18%	20%
Monomer solution (solution G)	180 ml	210 ml	240 ml	270 ml	300 ml
4× resolving gel buffer (solution H)	113 ml	113 ml	113 ml	113 ml	113 ml
Glycerol (87% [w/w])	31 ml	31 ml	31 ml	31 ml	31 ml
10% SDS (solution J)	4.5 ml	4.5 ml	4.5 ml	4.5 ml	4.5 ml
Double-distilled water	119.9 ml	89.9 ml	59.9 ml	29.9 ml	0 ml
10% ammonium persulfate [†] (solution K)	1.4 ml	1.4 ml	1.4 ml	1.4 ml	1.4 ml
TEMED [†]	0.225 ml	0.225 ml	0.225 ml	0.225 ml	0.225 ml
Total volume	450 ml	450 ml	450 ml	450 ml	450 ml

* Preparation of stock solutions is described in appendix I, solutions G, H, J, and K. Adjust as necessary for the thickness of the gels and the number of gels cast.

[†] Add after (optional) deaeration.

3.3.8 Preparing Ettan DALT electrophoresis units for electrophoresis using lab-cast gels

For Ettan DALT electrophoresis units, the lower tank requires 1× SDS electrophoresis buffer while the upper chamber requires buffer of a higher concentration. Prepare the required buffers as described in Table 28 (preparation of stock solutions is described in appendix I, solutions M and F).



For Ettan DALT Gel 12.5, the DALT Buffer Kit must be used to prepare the anode and cathode buffers described in section 3.3.1.

Table 28. Tank buffer solutions for Ettan DALT systems with lab-cast Laemmli gels.

System	Anodic buffer (lower buffer chamber)	Volume (l)	Cathodic buffer (upper buffer chamber)	Volume (ml) Dilute from 10× stock
Ettan DALTsix				
1.0-mm gels	1× SDS electrophoresis buffer	~4.3	2× SDS electrophoresis buffer	800
1.5-mm gels	1× SDS electrophoresis buffer	~4.3	3× SDS electrophoresis buffer	800
Ettan DALTwelve				
1.0- or 1.5-mm gels	1× SDS electrophoresis buffer	7.5	2× SDS electrophoresis buffer	2500

Protocol: Preparing Ettan DALTsix for use

1. Fill the electrophoresis tank with 4.3 l of 1× SDS electrophoresis buffer.
2. Turn on the pump.
3. Switch on the MultiTemp III temperature controller and set the desired temperature.



A temperature of 10 °C is recommended for rapid electrophoresis. Equilibrate the buffer temperature to at least 15 °C before starting the run.

Protocol: Preparing Ettan DALTwelve for use

Fill the anodic chambers of the tank with 1× SDS electrophoresis buffer.

1. Set the valve on the separation unit to “circulate.” Fill the tank to the 7.5 l fill line with 1× SDS electrophoresis buffer.
2. Switch on the separation unit.
3. Turn on the pump to mix the buffers and set the separation unit to desired temperature.



A temperature of 25 °C is recommended for rapid electrophoresis.

3.3.9 Equilibrating Immobiline DryStrip gels with lab-cast gels

When the buffer tank has reached the desired temperature, start equilibrating the Immobiline DryStrip gel as described in section 3.1.2. The equilibration procedure is the same whether applying the strip to precast or lab-cast gels.

3.3.10 Applying Immobiline DryStrip gels to lab-cast gels

To apply the Immobiline DryStrip gel to the lab-cast gel, follow the procedure as described in section 3.3.4.

3.3.11 Inserting lab-cast gels into Ettan DALT electrophoresis units

To insert lab-cast gels into Ettan DALT electrophoresis units, follow the procedure described in section 3.3.5.

3.3.12 Electrophoresis conditions with lab-cast gels

Follow the procedure described in section 3.3.6.

3.3.13 Troubleshooting

See section 3.5.

3.4 Electrophoresis using other vertical electrophoresis systems

Several other electrophoresis units work well for second-dimension separation. Choice is to a large degree dependent on the length of the Immobiline DryStrip used in the first-dimension.

Two systems, miniVE and SE 260, are ideal for running up to two second-dimension gels with 7-cm Immobiline DryStrip gels. Spacers (1.0 and 1.5 mm) are available as well as two plate lengths (8 or 10.5 cm).

SE 600 Ruby units can be used to cast and run up to four gels 16 cm in length. Divider plates allow two gels to be cast and run together on each side of the gel tank. The width of the gels can either be 14 or 16 cm, depending on the width of the spacers chosen, which allows SE 600 Ruby to accommodate either 11- or 13-cm Immobiline DryStrip gels, respectively. Several gel casters are available, including a 10-gel caster. Low-fluorescent glass plates are also available for use in SE 600 Ruby.

SE 600 Ruby requires an external power supply such as the EPS 601 and an external recirculating water bath (such as MultiTemp III Thermostatic Circulator) if temperature control is desired.

3.4.1 Preparing caster and gel sandwich for miniVE, SE 260, and SE 600 Ruby electrophoresis systems

Protocol

1. Select gel thickness for the system

Either 1.0- or 1.5-mm-thick spacers can be used for all the smaller vertical formats. Thinner gels stain and destain more quickly and generally give less background staining. Thicker gels have a higher protein capacity. Thicker gels are also less fragile and easier to handle.

2. Assemble unit

Mount the clamps, spacers, and glass plates to a sandwich. Put the sandwich into the caster using the cams.

See instructions accompanying unit for full details.

3.4.2 Preparing lab-cast gels for miniVE, SE 260, and SE 600 Ruby electrophoresis systems



Some of the chemicals used in the procedures—acrylamide, N,N'-methylenebisacrylamide, ammonium persulfate, TEMED, thiourea, DTT, and iodoacetamide—are very hazardous. Acrylamide monomer, for example, is a neurotoxin and suspected carcinogen. You should have a manufacturer's safety data sheet (MSDS) detailing the properties and precautions for all chemicals in your laboratory. These safety data sheets should be reviewed prior to starting the procedures described in this handbook. General handling procedures for hazardous chemicals include using double latex gloves for all protocols. Hazardous materials should be weighed in a fume hood while wearing a disposable dust mask. Follow all local safety rules and regulations for handling and disposal of materials.

Quick guide for finding information on gel casting for miniVE, SE 260, and SE 600 Ruby electrophoresis systems

To find gel-casting information quickly, refer to Table 29 for gel volumes required, Table 30 for single percentage gel recipes, and Table 31 for gradient gel recipes.

The instructions provided below for the preparation of vertical SDS-polyacrylamide gels employ the Tris-glycine system of Laemmli (78).

Protocol

1. Select the gel percentage

See section 3.3.7, protocol instruction 1. Select the gel percentage.

2. Calculate the required casting solution volume

The total volume of solution required depends on the gel size, the gel thickness, and the number of gels cast. Table 29 gives volumes of gel solution required per gel.

3. Calculate the formulation of the gel solution

The recipes given in Table 30 produce 100 ml of solution for a single percentage gel. The recipes in Table 31 produce 50 ml each of light and heavy solution for a gradient gel. These recipes can be scaled up or down, depending on the volume required.

4. Prepare the gel solution

Make up the gel solution without TEMED or ammonium persulfate.

Note: An optional deaeration step may be performed at this point. To do so, make up the solution in a vacuum flask. Add a small magnetic stirring bar. Stopper the flask and apply a vacuum for several minutes while stirring on a magnetic stirrer.

Just before casting the gel, add TEMED and 10% ammonium persulfate. Gently swirl the flask to mix, being careful not to generate bubbles. Immediately pour the gel.

5. Pour and prepare the gel

Fill the gel cassette to 5–10 mm below the top (no stacking gel layer is required).

Overlay each gel with a layer of water-saturated 1-butanol (0.3 ml) immediately after pouring to minimize gel exposure to oxygen and to create a flat gel surface.

After allowing a minimum of 2 h for polymerization, remove the overlay and rinse the gel surface with gel storage solution (see appendix I, solution L).



Do not allow the overlay of water-saturated 1-butanol to remain on the gel for more than 2–3 h. If leaving the gel for a longer period of time, replace the 1-butanol with an overlay of running buffer.

6. Storage of unused gels

Gels not used immediately can be stored at 4 °C for up to two weeks. Gel storage solution (see appendix I, solution L) is pipetted over the top gel surface and the gel cassette is sealed with flexible paraffin film. Alternatively, the gel cassettes can be stored fully immersed in gel storage solution.

For further information on the preparation of second-dimension vertical SDS slab gels, refer to the user manuals for the respective electrophoresis system and multiple gel caster.

Table 29. Volumes required per vertical gel (miniVE, SE 260, and SE 600 Ruby systems).

Casting system	Volume (ml)
miniVE and SE 260 (10 × 10.5 cm plates)	
1-mm-thick spacers	10
1.5-mm-thick spacers	15
SE 600 Ruby (18 × 16 cm plates)	
2-cm wide × 1-mm thick spacers	30
2-cm wide × 1.5-mm thick spacers	40
1-cm wide × 1-mm thick spacers	30
1-cm wide × 1.5-mm thick spacers	45

Table 30. Single-percentage gel recipes for miniVE, SE 260, and SE 600 Ruby systems.*

Final gel concentration	5%	7.5%	10%	12.5%	15%
Monomer solution (solution G)	16.7 ml	25 ml	33.3 ml	41.7 ml	50 ml
4x resolving gel buffer (solution H)	25 ml	25 ml	25 ml	25 ml	25 ml
10% SDS (solution J)	1 ml	1 ml	1 ml	1 ml	1 ml
Double-distilled water	56.8 ml	48.5 ml	40.2 ml	31.8 ml	23.5 ml
10% ammonium persulfate [†] (solution K)	500 µl	500 µl	500 µl	500 µl	500 µl
TEMED [†]	33 µl	33 µl	33 µl	33 µl	33 µl
Total volume	100 ml	100 ml	100 ml	100 ml	100 ml

* Preparation of stock solutions is described in appendix I, solutions G, H, J, and K.

[†] Ammonium persulfate and TEMED are added immediately prior to casting the gel.

Table 31. Recipes for gradient gels for miniVE, SE 260, and SE 600 Ruby systems.*

Light solution – Final concentration	5%	7.5%	10%	12.5%	15%
Monomer solution (solution G)	8.4 ml	12.5 ml	16.5 ml	21.0 ml	25 ml
4x resolving gel buffer (solution H)	12.5 ml	12.5 ml	12.5 ml	12.5 ml	12.5 ml
10% SDS (solution J)	500 µl	500 µl	500 µl	500 µl	500 µl
Double-distilled water	28.5 ml	24.5 ml	20.0 ml	16.0 ml	12.0 ml
10% ammonium persulfate [†] (solution K)	170 µl	170 µl	170 µl	170 µl	170 µl
TEMED [†]	17 µl	17 µl	17 µl	17 µl	17 µl
Total volume	50 ml	50 ml	50 ml	50 ml	50 ml

Heavy solution – Final concentration	10%	12.5%	15%	17.5%	20%
Monomer solution (solution G)	16.7 ml	21.0 ml	25.0 ml	29.2 ml	33.3 ml
4x resolving gel buffer (solution H)	12.5 ml	12.5 ml	12.5 ml	12.5 ml	12.5 ml
Sucrose	7.5 g	7.5 g	7.5 g	7.5 g	7.5 g
10% SDS (solution J)	500 µl	500 µl	500 µl	500 µl	500 µl
Double-distilled water	16.2 ml	11.7 ml	7.7 ml	3.5 ml	0 ml
10% ammonium persulfate [†] (solution K)	165 µl	165 µl	165 µl	165 µl	165 µl
TEMED [†]	16.5 µl	16.5 µl	16.5 µl	16.5 µl	16.5 µl
Total volume	50 ml	50 ml	50 ml	50 ml	50 ml

* Preparation of stock solutions is described in appendix I, solutions G, H, J, and K.

[†] Ammonium persulfate and TEMED are added immediately prior to casting the gel.

3.4.3 Preparing miniVE, SE 260, and SE 600 Ruby systems for electrophoresis

For these electrophoresis units, prepare enough 1x SDS electrophoresis buffer according to Table 32 (preparation of stock solutions is described in appendix I, solution M).

Table 32. Gel tank buffer volumes for miniVE, SE 260, and SE 600 Ruby electrophoresis systems.

System	Gel tank buffer volume (l)
miniVE	1.5
SE 260	0.6
SE 600 Ruby	5

Fill the anode buffer tank with SDS electrophoresis buffer. Set the temperature if applicable.

3.4.4 Equilibrating Immobiline DryStrip gels

To equilibrate the Immobiline DryStrip gel, see section 3.1.2. The equilibration procedure is the same whether applying the strip to precast or lab-cast gels.

3.4.5 Applying Immobiline DryStrip gels

Protocol

1. Dip the Immobiline DryStrip gel in SDS Buffer.
2. While the SDS gels still are in the gel caster, apply the Immobiline DryStrip gels on top of them. Push the strips gently down to the gel surface.
3. Seal the Immobiline DryStrip gel in place with melted agarose. See appendix I, solution N, Agarose sealing solution.

3.4.6 Inserting gels into miniVE, SE 260, and SE 600 Ruby systems

Protocol: miniVE

For detailed information, refer to the miniVE user manual.

1. Make sure the sealing plate is in the “half open” position.
2. Lower each module into the tank, seating it in the locating slots.
3. Add the appropriate amount of electrophoresis buffer to the tank and to the upper buffer chamber.
4. Attach or close the lid and connect the power leads to the power supply.

Protocol: SE 260 system

For detailed information, refer to the SE 260 user manual.

1. Apply the SDS gel to the electrophoresis tank.
2. Clamp the gel in position and fill up the anode and cathode buffer chambers.
3. Attach or close the lid and connect the power leads to the power supply.

Protocol: SE 600 Ruby system

For detailed information, refer to the SE 600 Ruby user manual.

1. Fit the slotted gasket in the upper buffer chamber.
2. Put the upper buffer chamber onto the gel sandwiches in the casting stand. Fix the gel sandwich to the upper buffer chamber with the cams and release the gel sandwich from the caster.
3. Fit the upper buffer chamber with the gel sandwiches onto the lower buffer chamber.
4. Fill the upper buffer chamber with Laemmli SDS buffer.
5. Attach or close the lid and connect the power leads to the power supply.
6. Set the temperature control if desired.
7. Stir the SE 600 Ruby lower tank buffer to maintain an even buffer temperature around the gels.

If using only one gel in SE 600 Ruby and SE 260 units, the second side of the unit will need to be blocked with a buffer-dam assembly or two glass plates clamped together (no spacers) to prevent current leakage. For detailed information, please consult the respective instrument user manuals.

3.4.7 Electrophoresis conditions

Table 33 lists the recommended conditions for miniVE, SE 260, and SE 600 Ruby. Electrophoresis is performed at constant current in two steps. During the initial migration and stacking period (Step 1), the current is approximately half of the value required for the separation (Step 2), as can be seen from Table 33.

Stop electrophoresis when the dye front is approximately 1 mm from the bottom of the gel.

For these vertical systems, cooling is optional. However, temperature control improves gel-to-gel reproducibility, especially if the ambient temperature of the laboratory fluctuates significantly.

For best results, gels should be run at 25 °C.

After electrophoresis, remove gels from their gel cassettes in preparation for staining or blotting. Notch or mark each gel at the upper corner nearest the “+” or “-” end of the Immobiline DryStrip gel to identify the acidic end of the first-dimension separation.

Table 33. Recommended electrophoresis conditions for second-dimension vertical gels.

	Step	Current (mA/gel)	Approximate run duration (h:min)
miniVE and SE 260			
1.0-mm-thick gels	1	10	0:15
	2	20	1:30*
1.5-mm-thick gels	1	15	0:15
	2	30	1:30*
SE 600 Ruby			
1.0-mm-thick gels	1	10	0:15
	2	50–20	2:00–5:00*
1.5-mm-thick gels	1	15	0:15
	2	60–30	2:00–5:00*

* The time shown is approximate. Stop electrophoresis when the dye front is 1 mm from the bottom of the gel.



If running at the higher currents, cooling is highly recommended.

3.5 Troubleshooting

Table 34 lists possible problems that might be encountered during vertical SDS-PAGE and how to solve them.

Table 34. Troubleshooting vertical second-dimension SDS-PAGE.

Symptom	Possible cause	Remedy
No current at start of run	Insufficient volume of buffer in upper or lower reservoir.	Ensure that both reservoirs contain enough SDS electrophoresis buffer to contact both upper and lower electrode wires. Check for leaks.
Second-dimension separation proceeds too slowly	SDS electrophoresis buffer prepared incorrectly, or resolving gel buffer prepared incorrectly.	Make fresh solutions.
	Current leakage.	Make sure all the slots in the electrophoresis unit are filled with either a gel or a blank cassette.
	Acrylamide solution is too old.	Prepare fresh monomer stock solution.
Dye front curves up (smiles) at the edges	Gel temperature is not uniform.	Regulate gel temperature using a thermostatic circulator. Use the maximum possible volume of buffer in the lower reservoir.
	Current or power too high.	Limit current or power to values suggested in Table 23.
Dye front curves down (frowns)	Gel is poorly polymerized near the spacers.	Degas the gel solution, or increase the amount of ammonium persulfate and TEMED by 50%.
	Improper instrument assembly (SE 600 Ruby).	Ensure that the gasket is not pinched.
	Leakage of upper reservoir.	Ensure that an adequate level of buffer is in the upper reservoir.

continues on following page

Table 34. Troubleshooting vertical second-dimension SDS-PAGE (continued).

Symptom	Possible cause	Remedy
Second-dimension separation proceeds slowly with high current	All of the slots in the sealing assembly are not occupied by either gel cassettes or blank cassettes.	Ensure that all slots in the electrophoresis unit are occupied.
	Anodic buffer has mixed with cathodic buffer from overflowing of either the cathodic reservoir or the anodic reservoir (Etan DALT systems).	Do not pour more than the suggested volume (7.5 l) into the lower reservoir. Ensure that the level of the anode buffer does not come above the sealing assembly when the electrophoresis unit is fully loaded. If excess anode buffer is in the upper reservoir, it should be removed with a pipette. Ensure that the level of cathode buffer does not come above the air vents in the corners of the upper reservoir.
		Lack of mixing between upper and lower reservoirs can be verified by adding bromophenol blue dye to the lower reservoir prior to loading the unit with gels. Several drops of 1% (w/v) bromophenol blue will impart sufficient color to the anode buffer.
Incomplete gel polymerization	Chemicals.	Use only fresh stocks of the highest-quality reagents. If the dry ammonium persulfate does not "crackle" when added to water, replace it with fresh stock. Increase TEMED or ammonium persulfate concentration, or both.
	Oxygen.	Remove oxygen from the gel environment. Degas the monomer solution 5–10 min before pouring and then overlay the gel surface with water-saturated 1-butanol.
	Temperature.	Adjust the gel solution temperature to a minimum of 20 °C, especially for gels with low acrylamide concentration.
Pronounced downward curving of the dye front on one or both sides of the DALT Gel 12.5	There is an unfilled gap between the gel and one of the spacers.	When sealing the Immobiline DryStrip gel into place on top of the gel, ensure that some of the sealing solution flows down any gap that may exist between the gel and spacer.
	Precast gel cassette(s) not properly closed.	Ensure cassette(s) are properly closed.

4. Use of the flatbed Multiphor II Electrophoresis System for first and second dimensions

4.0 Overview

Multiphor II Electrophoresis System is a versatile flatbed system that provides excellent resolution and rapid separations in large-format gels that are efficiently and uniformly cooled through a ceramic cooling plate connected to the cooling unit. This improves resolution and speed at high voltages.

The modular design of the Multiphor II Electrophoresis System gives it the flexibility to handle virtually any flatbed electrophoretic technique. It is particularly well suited for ultra-thin gels (0.1–0.5 mm) on glass or plastic supports up to sizes of 20 × 26 cm.

Multiphor II Electrophoresis System comprises a buffer tank with four leveling feet, ceramic (aluminum oxide) cooling plate with accessories, polycarbonate safety lid, and electrode holder with movable EPH/IEF electrodes (for buffer strips and electrode strips). In addition to accommodating gels of different sizes, the electrodes make secure, uniform contact with buffer strips, eliminating the need for large volumes of liquid buffers. Buffer strips can be positioned and held in place using Multiphor II Buffer Strip Positioner.

To complete the Multiphor II Electrophoresis System, EPS 3501 XL Power Supply and MultiTemp III Thermostatic Circulator are also required.

As described below, Multiphor II Electrophoresis System can be used for both first-dimension IEF and second-dimension SDS-PAGE. Strip rehydration with or without sample included is performed in the Immobiline DryStrip IPGbox. After rehydration, the Immobiline DryStrip gels are transferred to the electrophoresis unit for first-dimension IEF using the Immobiline DryStrip Kit accessory.

4.1 First-dimension IEF using Multiphor II Electrophoresis System and Immobiline DryStrip Kit

Multiphor II Electrophoresis System can be readily configured for first-dimension IEF separations by incorporating an Immobiline DryStrip Kit, and choosing the Immobiline DryStrip gel and IPG Buffer to match the required pH gradient. When equipped with Immobiline DryStrip Kit, the system can run up to 12 Immobiline DryStrip gels simultaneously, with gel lengths up to 24 cm. Focusing time depends on the gel length, pH range, and the nature of the sample but can be expected to be in the range of 2–72 h.

DryStrip gels are rehydrated using a Reswelling Tray (accessory) in a solution containing the necessary additives and, optionally, the sample proteins (rehydration solution is described in detail in section 2.6). IEF is performed by gradually increasing the voltage across the Immobiline DryStrip gels to at least 3500 V, and maintaining this voltage for at least several thousand Volt-hours. After IEF, the Immobiline DryStrip gels are equilibrated in equilibration solution and applied onto SDS-polyacrylamide gels for the second-dimension separation.

Sample can be loaded using rehydration loading, cup loading, or paper-bridge loading. Each of these is described in more detail later in this chapter. Figure 45 provides guidelines for selecting the appropriate mode of sample application.

Multiphor II Electrophoresis System

pH gradient	Analytical		Preparative	
3.5–4.5				
3.0–5.6 NL				
4.0–7.0				
3.0–7.0 NL	Rehydration loading	Cup loading	Rehydration loading	paper-bridge loading
5.3–6.5				
3.0–10.0				
3.0–10.0 NL				
3.0–11.0 NL				
6.2–7.5				
6.0–9.0				
6.0–11.0				
7.0–11.0 NL				

Fig 45. Guidelines for selecting the appropriate mode of sample application in the Multiphor II Electrophoresis System.

For cup loading, sample is pipetted into sample cups precisely positioned on the surface of the Immobiline DryStrip gels. Up to 100 µl per strip can be applied through sample cups, and up to 850 µl with paper-bridge loading (74).

4.1.1 Immobiline DryStrip gel rehydration—IPGbox

IPGbox allows up to 12 strips (up to 24 cm long) to be rehydrated independently and simultaneously. Samples can be loaded during rehydration by including them in the rehydration buffer (rehydration loading). Alternatively, samples can be applied to rehydrated strips via sample cups or paper-bridge loading.

For protocol, see section 2.7 (page 57).

Table 35. Rehydration solution volume per Immobiline DryStrip gel—Multiphor II protocol.

Immobiline DryStrip gel length (cm)	Total volume per strip* (µl)
7	125
11	200
13	250
18	340
24	450

* Including sample, if applied.



Table 36. Troubleshooting Immobiline DryStrip gel rehydration in IPGbox.

Symptom	Possible cause	Remedy
Uneven or incomplete rehydration of strips	Depending on the Immobiline DryStrip gel pH interval and the pH of the rehydration solution, either the basic end or the acidic end will swell faster than the other. The strip may not necessarily be of an even thickness following rehydration.	At the start of rehydration, ensure that the rehydration solution is evenly distributed under the Immobiline DryStrip gel. Move the gel strip back and forth to aid distribution. The gel strip should float on the rehydration solution.
	Unopened Immobiline DryStrip gel package was stored at or above room temperature for too long.	Store Immobiline DryStrip gels sealed at a temperature below -20 °C.
	Immobiline DryStrip gels were stored at or above room temperature for too long.	Do not allow dry Immobiline DryStrip gels to remain at room temperature for longer than 10 min as they will pick up moisture from the air.
	Incorrect volume of rehydration solution used.	Make sure the correct amount of rehydration solution according to Table 35 is added to the channel in the Immobiline DryStrip IPGbox. Check calibration of pipettors.
	Rehydration time is too short.	Rehydrate the Immobiline DryStrip gels for at least 10 h.

4.1.2 Preparing for IEF

The components of the Immobiline DryStrip Kit include a tray and electrode holder, anode and cathode electrodes, an Immobiline DryStrip aligner, a sample cup bar, and sample cups.



Procedures A and B below should be completed before the Immobiline DryStrip gels are removed from the Immobiline DryStrip IPGbox.

A. Prepare the Immobiline DryStrip Kit

1. Clean all components of the Immobiline DryStrip Kit

The Immobiline DryStrip tray, Immobiline DryStrip aligner, electrodes, sample cup bar, and sample cups must be clean and ready for use. Clean with detergent, rinse thoroughly with distilled water, and allow to dry.

2. Confirm electrical connections on Multiphor II Electrophoresis System

Check that the red bridging cable in the Multiphor II unit is connected (seated under the cooling plate).

3. Establish cooling

Set the temperature on MultiTemp III Thermostatic Circulator to 20 °C. Position the cooling plate on the Multiphor II unit and ensure that the surface is level.

4. Position the Immobiline DryStrip tray

Pipette approximately 3–4 ml of Immobiline DryStrip Cover Fluid onto the cooling plate. Position the Immobiline DryStrip tray on the cooling plate so the red (anodic) electrode connection of the tray is positioned at the top of the plate near the cooling tubes. Remove any large bubbles between the tray and the cooling plate; small bubbles can be ignored. Immobiline DryStrip Cover Fluid serves as an electrical insulating fluid to ensure good thermal contact between the cooling plate and the tray. Connect the red and black electrode leads on the tray to the Multiphor II unit.

5. Position the Immobiline DryStrip aligner

Pour approximately 10 ml of Immobiline DryStrip Cover Fluid into the Immobiline DryStrip tray. Place the Immobiline DryStrip aligner, 12-groove side up, into the tray on top of the Immobiline DryStrip Cover Fluid. The presence of air bubbles between the strip positions under the aligner will not affect the experiment. For easier visualization of the grooves in the aligner, avoid getting Immobiline DryStrip Cover Fluid on top of the aligner.

B. Prepare electrode strips

1. Cut electrode strips to size

Cut two IEF electrode strips to lengths of 110 mm each.

2. Soak electrode strips with distilled water

Place the electrode strips on a clean, flat surface such as a glass plate. Soak each electrode strip with 0.5 ml distilled water. Blot with filter paper to remove excess water.



Electrode strips must be damp, not wet. Excess water may cause streaking.

C. IEF with rehydration loading

1. Remove the rehydrated Immobiline DryStrip gel from the Immobiline DryStrip IPGbox

To remove an Immobiline DryStrip gel from the Immobiline DryStrip IPGbox, slide the tip of a pair of forceps along the sloped end of the channel and into the slight depression under the Immobiline DryStrip gel. Grasp the end of the strip with the forceps and lift the strip out of the tray.

2. Position the Immobiline DryStrip gel in the Immobiline DryStrip aligner

Immediately transfer the rehydrated Immobiline DryStrip gels (gel side up) to adjacent grooves of the aligner in the Immobiline DryStrip tray (Fig 48). Place the strips with the acidic ends at the top of the tray near the red electrode (anode). The other ends should be at the bottom of the tray near the black electrode (cathode). Align the Immobiline DryStrip gels so the anodic gel edges are lined up.

3. Attach the electrode strips

Place the moistened electrode strips laterally across the cathodic and anodic ends of the aligned Immobiline DryStrip gels. The electrode strips must at least be in partial contact with the gel surface of each Immobiline DryStrip gel.

4. Position the electrodes

Each electrode has a side marked red (anode) or black (cathode). Align each electrode over an electrode strip, ensuring the marked side corresponds to the side of the tray giving electrical contact. When the electrodes are properly aligned, press them down to contact the electrode strips. Check that the Immobiline DryStrip gels are still aligned in their grooves (Fig 49).

5. Overlay the Immobiline DryStrip gel with Immobiline DryStrip Cover Fluid

Overlay each Immobiline DryStrip gel with 3 ml of Immobiline DryStrip Cover Fluid to minimize evaporation and urea crystallization.



Fig 48. Positioning Immobiline DryStrip gels in the Immobiline DryStrip aligner.



Fig 49. Alignment of electrodes over Immobiline DryStrip gels.

4.1.3 Sample application by cup loading



If the sample was not applied by means of the rehydration solution, it can be applied using the sample cups immediately prior to isoelectric focusing. When sample cups are used, the sample load limits are lower and more specific.

Guidelines on suitable sample loads for different gradients and Immobiline DryStrip gels are given in Table 16 (see section 2.5). These values should only be regarded as a rough guide. Suitable sample loads will vary greatly between samples and with the sensitivity of the staining method used.

Protocol

1. Prepare the sample

Prepare the sample in a solution similar in composition to the rehydration solution used.

2. Determine the point of sample application

The optimal application point depends on the characteristics of the sample. When the proteins of interest have acidic pI's or when SDS has been used in sample preparation, sample application near the cathode is recommended. Anodic sample application is necessary with pH 6–11 and 6–9 gradients and preferred when pH 3–10 gradients are used. The optimal application point can vary with the nature of the sample. Empirical determination of the optimal application point is best.

3. Position the sample cup bar

Place sample cups on the sample cup bar, high enough on the bar to avoid touching the gel surface. Position the sample cup bar so the sample cups are a few millimeters away from the cathodic or anodic electrode, depending on your sample. The sample cups must face the electrode. The sample cup bar has a spacer on one side; slide the sample cup bar toward the anode/cathode until the spacer just touches the anodic/cathodic electrode.

4. Press the sample cups against the Immobiline DryStrip gels

Move the sample cups into position, one sample cup above each Immobiline DryStrip gel, and gently press the sample cups down to ensure good contact with each Immobiline DryStrip gel (Fig 50). This is the most critical part of the setup. Check that strips are in their correct, straight position in the Immobiline DryStrip aligner.

5. Apply Immobiline DryStrip Cover Fluid

Once the sample cups are properly positioned, pour 70–80 ml Immobiline DryStrip Cover Fluid into the tray to completely cover the Immobiline DryStrip gels. If the Immobiline DryStrip Cover Fluid leaks into the sample cups, remove it with a pipette, correct the leakage, and check for leakage again. Add approximately 150 ml of Immobiline DryStrip Cover Fluid to completely cover the sample cups. The Immobiline DryStrip gels are submerged under a layer of Immobiline DryStrip Cover Fluid to prevent drying of the gel, precipitation of the components of the rehydration solution, and diffusion of gas into the gel.

6. Apply the sample

Apply sample (up to 100 μ l per Immobiline DryStrip gel) into the sample cups by pipetting under the surface of the Immobiline DryStrip Cover Fluid (Fig 51). The sample should sink to the bottom of the cup. Check for leakage.

7. Start IEF

Ensure that the electrodes on the tray are connected and place the lid on the Multiphor II unit. Connect the leads on the lid to the power supply. Ensure that the current check on the EPS 3501 XL Power Supply is switched off. Begin IEF.



When sample is applied via sample cups, precipitates can form at the application point and the amount of protein that can be loaded is less than if the sample was included in the rehydration solution. Protein precipitation and aggregation at the application point can sometimes be avoided by observing the following:

- The sample should contain urea, nonionic detergents, and IPG Buffer or carrier ampholytes.
- Apply the sample in dilute solutions (60–100 μ g protein per 100 μ l).



For micropreparative applications, rehydration loading is recommended. Paper-bridge loading is recommended if using basic strips (see section 4.1.4).

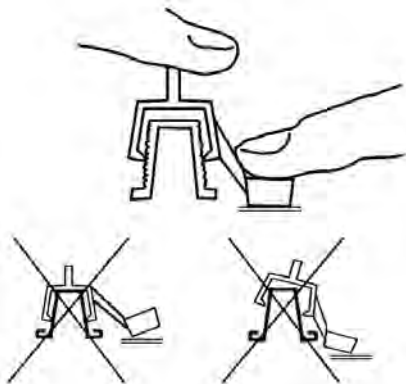

Fig 50. Attaching sample cups to the cup bar and pressing them against Immobiline DryStrip gels.

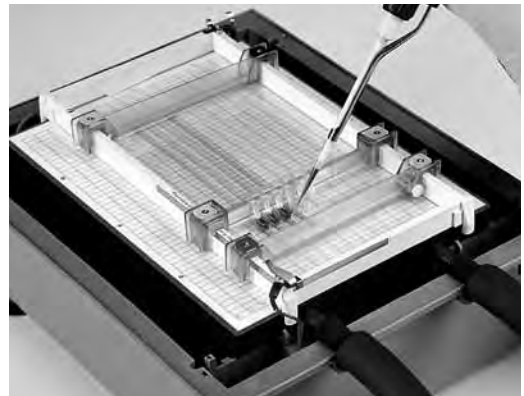

Fig 51. Applying sample into sample cups.

4.1.4 Paper-bridge loading

Higher sample volumes and protein amounts can be applied with paper bridges that are placed between the anodic or cathodic end of the Immobiline DryStrip gel and the electrode strip. A large sample volume requires a large paper pad applied at the opposite end to absorb excess water.

Paper bridges and electrode pads are cut from 1-mm-thick CleanGel electrode strips (see ordering information) to a size of 15 \times 25 mm and with an arrowhead as shown in Figure 52. The rehydrated Immobiline DryStrip gel is positioned directly on the glass bottom of the Immobiline DryStrip tray. Up to four Immobiline DryStrip gels can be run simultaneously on the Multiphor II Electrophoresis System. The arrow-headed paper, to which 375 μ l sample solution has been added, is then positioned at the anodic or the cathodic end of the Immobiline DryStrip gel.

To hold the paper bridge and Immobiline DryStrip gel in place, press a sample cup positioned on the sample cup bar down on top of the arrowhead. A solution containing up to 10 mg protein (in 850 μ l sample solution applied to a 15 \times 50 paper bridge) can be loaded on an 18-cm-long, narrow-pH-range Immobiline DryStrip gel under favorable conditions (74). The application point (anodic or cathodic) is of key importance for obtaining good results.

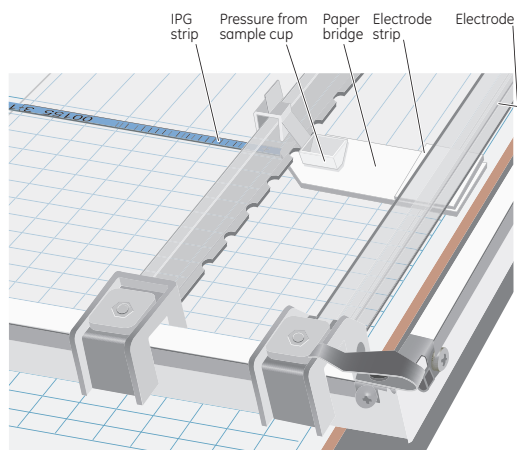





Fig 52. Setup for sample application via a paper bridge.

4.1.5 IEF guidelines for Multiphor II Electrophoresis System



IEF using the Multiphor II Electrophoresis System is conducted at high voltages (up to 3500 V) and very low currents (typically less than 1 mA) due to the low ionic strength within Immobiline DryStrip gels. During IEF, the current decreases while the voltage increases as proteins and other charged components migrate to their equilibrium positions. In a typical IEF protocol, voltage is gradually increased to the final desired focusing voltage, which is held for several hours or more. With cup loading, a low initial voltage minimizes sample aggregation and generally allows the parallel separation of samples with differing salt concentrations.

The main factors determining the required volt-hours (Vh) are the length of the Immobiline DryStrip gels and the pH gradient used. Sample composition, rehydration solution composition, and sample application mode influence the required volt-hours. Table 37 gives volt-hour values suitable for most samples with rehydration loading or anodic cup loading.

-  Cathodic sample application on wide-range gradients pH 3–10 requires considerably longer focusing times than those stated in Table 37, especially if SDS-containing samples are used. As an example, an SDS-solubilized serum protein sample applied at the cathodic end of a pH 3–10 NL gradient requires Volt-hours in excess of 2–2.5-fold of that stated in Table 37 (75).
-  Salt and buffer ions in the sample can require an increase of the time for phase 2 compared with the values given in Table 37, particularly when cup loading is used. High ion concentrations in the sample can also require an increase of the total Volt-hour requirement, as these ions have to be transported to the ends of the Immobiline DryStrip gels. Larger quantities of protein require more time to focus.
-  Focusing for substantially longer than recommended will cause horizontal streaking and loss of proteins. This phenomenon is called “over-focusing”. Therefore, focusing time should be reduced to the minimum necessary (see chapter 7, Troubleshooting).

4.1.6 Protocol examples

The protocols in Table 37 are suitable for first-dimension isoelectric focusing of protein samples in typical analytical quantities (Table 16) with IPG Buffer concentrations of 0.5 to 2% in the rehydration solution. The optimal focusing time will vary with the nature of the sample, the amount of protein, and how the sample is applied.

-  For higher protein loads (up to 1 mg or more) the final focusing step of each protocol can be extended by an additional 20% of the total recommended Volt-hours if necessary.
-  Sample application onto pH 6–11, pH 6–9, and pH 7–11 NL Immobiline DryStrip gels by rehydration loading is less likely to give high-quality 2-D results and should be avoided. Samples should be applied using cup loading at the acidic end of the Immobiline DryStrip gel, coupled with use of DeStreak Reagent.

4.1.7 Running a Multiphor II protocol

Ensure that the electrodes in the Immobiline DryStrip tray are connected and place the lid on the Multiphor II unit. Connect the leads on the lid to the power supply. Ensure that the current check on the EPS 3501 XL Power Supply is switched off. Begin IEF.

 As isoelectric focusing proceeds, the bromophenol blue tracking dye migrates toward the anode. Note that the dye front leaves the Immobiline DryStrip gel well before focusing is complete, so clearing of the dye is no indication that the sample is focused. If the dye does not migrate, no current is flowing. If this occurs, check the contact between the electrodes and the electrode strips. Also check that the electrode leads and bridging cable are correctly connected, and check that the electrodes are positioned properly so that the marked side contacts the side rail.

The protocols below are suitable for running 7–24-cm Immobiline DryStrip gels on the Multiphor II Electrophoresis System connected to EPS 3501 XL Power Supply.

 The focusing times given in Table 37 are guidelines only. They may vary with the nature of the sample and how the sample is applied. If using crude samples with high protein and salt content or using paper-bridge loading, the run time in total kilovolt-hours should be increased by 10%.

Table 37. Guidelines for running Immobiline DryStrip gels on Multiphor II Electrophoresis System. Running conditions: Temperature 20°C; current 2 mA total; power 5 W total. Program EPS 3501 XL Power Supply in gradient mode and with current check option turned off.

7-cm strips

pH intervals	Step	Voltage (V)	Time (h)	kVh
3–11 NL	1	200	0:01	
	2	3500	1:30	2.8
6–11	3	3500	0:40–1:05	2.2–3.7
	Total		2:10–2:35	5.0–6.5
3–10 NL	1	200	0:01	
4–7	2	3500	1:30	2.8
3–5.6 NL	3	3500	0:55–1:30	3.2–5.2
	Total		2:25–3:00	6.0–8.0
7–11 NL	1	300	0:01	
	2	3500	1:30	2.9
	3	3500	1:10–2:02	4.1–7.1
	Total		2:40–3:30	7.0–10.0
5.3–6.5	1	300	0:01	
6.2–7.5	2	3500	1:30	2.9
	3	3500	2:36–3:45	9.1–13.1
	Total		4:06–5:15	12.0–16.0

11-cm strips

pH intervals	Step	Voltage (V)	Time (h)	kVh
3–11 NL	1	300	0:01	
	2	3500	1:30	2.9
6–11	3	3500	1:45–2:35	6.1–9.1
	Total		3:15–4:05	9.0–12.0
4–7	1	300	0:01	
3–5.6 NL	2	3500	1:30	2.9
	3	3500	2:20–3:30	8.1–12.1
	Total		3:50–5:00	11.0–15.0
7–11 NL	1	300	0:01	
	2	3500	1:30	2.9
	3	3500	3:30–4:55	12.1–17.1
	Total		5:00–6:25	15.0–20.0
5.3–6.5	1*	500*	0:01*	
6.2–7.5	2	3500	1:30	3.0
	3	3500	7:10–9:10	25.0–32.0
	Total		8:40–10:40*	28.0–35.0

* To adjust this protocol for an overnight run, extend step 1 by 5 h (2.5 kVh) and reduce step 3 by 2.5 kVh.

13-cm strips

pH intervals	Step	Voltage (V)	Time (h)	kVh
3-10	1	300	0:01	
3-11 NL	2	3500	1:30	2.9
6-11	3	3500	3:10-4:00	11.1-14.1
	Total		4:40-5:30	14.0-17.0
3-10 NL	1	300	0:01	
4-7	2	3500	1:30	2.9
3-5.6 NL	3	3500	3:45-5:10	13.1-18.1
	Total		5:15-6:40	16.0-21.0
7-11 NL	1	500	0:01	
	2	3500	1:30	3.0
	3	3500	5:10-6:20	18.1-22.0
	Total		6:40-7:50	21.0-25.0
5.3-6.5	1*	500*	0:01*	
6.2-7.5	2	3500	1:30	3.0
	3	3500	10:00-12:50	35.0-45.0
	Total		11:30-14:20	38.0-48.0

* To adjust this protocol for an overnight run, extend the time of step 1 to 2h.

18-cm strips

pH intervals	Step	Voltage (V)	Time (h)	kVh
3-10	1	500	0:01	
3-11 NL	2	3500	1:30	3.0
6-11	3	3500	4:50-6:20	17.0-22.0
	Total		6:20-7:50	20.0-25.0
4-7	1	500	0:01	
3-10 NL	2*	500	6:00	3.0
3-5.6 NL	3	3500	1:30	3.0
	4	3500	5:25-9:25	19.0-30.0
	Total		12:55-16:55	25.0-36.0
6-9	1	500	0:01	
7-11 NL	2*	500	3:00	1.5
	3	3500	1:30	3.0
	4	3500	10:10-13:00	35.5-45.5
	Total		14:40-17:30	40.0-50.0
5.3-6.5	1	500	0:01	
6.2-7.5	2	3500	1:30	3.0
	3	3500	19:10-23:25	67.0-82.0
	Total		20:40-24:55	70.0-85.0

* This step is added to give a convenient overnight run (15 h). This step may be omitted. Step 4 should then be extended by 2.5 kVh.

24-cm strips

pH intervals	Step	Voltage (V)	Duration (h:min)	kVh
3-11 NL	1	500	0:01	
3-10	2*	500*	5:00*	2.5
	3	3500	1:30	3.0
	4	3500	8:30-11:20	29.5-39.5
	Total		15:00-17:50	35.0-45.0
3-10 NL	1	500	0:01	
4-7	2	3500	1:30	3.0
3-7 NL	3	3500	12:00-16:20	42.0-57.0
3-5.6 NL	Total		13:30-17:50	45.0-60.0
6-9	1	500	0:01	
7-11 NL	2	3500	1:30	3.0
	3	3500	16:20-22:00	57.0-77.0
	Total		17:50-23:30	60.0-80.0
3.5-4.5	1	500	0:01	
	2	3500	1:30	3.0
	3	3500	22:00-27:40	77.0-97.0
	Total		23:30-29:10	80.0-100.0
5.3-6.5	1	500	0:01	
6.2-7.5	2	3500	1:30	3.0
	3	3500	30:35-36:20	107.0-127.0
	Total		32:06-37:50	110.0-130.0

* This step is added to give a convenient overnight run (15 h). This step can be omitted. Step 4 should then be extended by 2.5 kVh.

4.1.8 Preservation of focused Immobiline DryStrip gels

After IEF is complete, proceed to the second-dimension separation immediately or store the Immobiline DryStrip gels at -60 °C or below. This can be conveniently done by placing the strips between plastic sheets, as suggested by Görg *et al.* (3) or on glass plates covered in plastic wrap. Alternatively, the DryStrip gels can be stored in screw-cap tubes. The 7-cm strips fit in disposable 15-ml conical tubes; 11-, 13-, and 18-cm strips fit in 25 × 200 mm screw cap culture tubes; and 18- and 24-cm strips fit in Equilibration Tubes (see ordering information). The equilibration process is discussed in section 3.1.

4.1.9 Troubleshooting



Table 38 lists possible problems that could be encountered during IEF using Multiphor II Electrophoresis System and how to solve them.

Table 38. Troubleshooting first-dimension IEF: Multiphor II Electrophoresis System and Immobiline DryStrip Kit.

Symptom	Possible cause	Remedy
Sample cups leak	Incorrect handling and placement of sample cups.	<p>Sample cups are fragile and should not be used too many times. Make sure the sample cups are aligned with the Immobiline DryStrip gels. Make sure the bottoms of the sample cups are flat against the surface of the Immobiline DryStrip gels.</p> <p>Note: Leaks can often be detected prior to sample application:</p> <ul style="list-style-type: none"> • Observe the Immobiline DryStrip Cover Fluid when it is poured into the Immobiline DryStrip Kit tray. If it leaks in through the bottom of the sample cups, reposition the cups, remove the cover fluid with a pipette, and check for leakage again. • An optional check for leakage is to add 0.01% bromophenol blue dye solution to the cups. If the dye leaks out of a cup, it must be corrected. (Important: the leaked detection dye must be removed from the sample cup before loading the sample.)
Low current	This is normal for Immobiline DryStrip gels, which have very low conductivity.	An Immobiline DryStrip gel run usually starts at 50–100 $\mu\text{A}/\text{strip}$ and drops during the run to below 10 $\mu\text{A}/\text{strip}$.
	<p>EPS 3501 XL Power Supply cannot detect the low μA range current and shuts off.</p> <p>IPG Buffer omitted from rehydration solution.</p>	<p>Because the EPS 3501 XL Power Supply can operate under very low currents, it is recommended for use with Immobiline DryStrip Kit and Immobiline DryStrip gels. Make sure the low-current shut-off has been bypassed (see 3501 XL Power Supply instructions). IPG runs may start in a current range that is not detectable by the EPS 3501 XL Power Supply.</p> <p>Always include IPG Buffer or Pharmalyte in the rehydration solution.</p>
No current at start of run	No electrode contact or lack of electrical continuity.	Check that all Multiphor II contacts are in place. Make sure the metal band within the electrode contacts the metal band along the side of the Immobiline DryStrip tray. Note that the metal band within the electrode is only on the end marked with the red or black circle. Ensure that the bridging cable under the cooling plate is properly installed.
	Immobiline DryStrip gels are improperly rehydrated.	Ensure that the Immobiline DryStrip gels are rehydrated along its entire length.
	The high-voltage lead from the electrophoresis unit is supply correctly.	Ensure that the plugs on the high-voltage leads fit securely into the output jacks on the power supply. Use the appropriate not plugged into the power adapter if necessary.
Sample dye does not move out of the sample cup	It is normal for several hours to elapse before the sample dye leaves the sample cups.	
	<p>The sample cups were pressed down so hard against the gel that they pushed through the gel to rest against the plastic backing. This blocks the current and physically prevents the protein from entering the Immobiline DryStrip gels.</p> <p>The ionic strength of the sample is higher than the gel. As a result, the field strength in the sample zone is inadequate to move the protein out of the sample zone at an appreciable rate.</p>	<p>Replace Immobiline DryStrip gel and re-apply sample cup.</p> <p>Dilute the sample as much as possible or, just prior to loading, dialyze the sample to remove salts.</p>
Sparking or burning of Immobiline DryStrip gels	Conductivity of the sample/Immobiline DryStrip gel is too high.	Ensure the sample is adequately desalted. Alternatively, before raising the voltage to maximum, include a prolonged low-voltage phase in the IEF protocol to allow the ions to move to the ends of the Immobiline DryStrip gel.

4.2 Second-Dimension SDS-PAGE using Multiphor II Electrophoresis System



As discussed in chapter 2, after IEF it is important to proceed immediately to gel equilibration, unless the IPG strip is being frozen (at -60 °C or below) for future analysis. Equilibration is always performed immediately prior to the second-dimension run, never prior to storage of the Immobiline DryStrip gels. See section 4.1.8 for details on preservation of the gels.



The second-dimension gel itself should be prepared and ready to accept the Immobiline DryStrip gel prior to equilibration.

Before proceeding further, refer to sections 3.1.1 and 3.1.2 for a discussion of the equilibration process. Note especially the discussion referring to the equilibration solution components and the need for a second equilibration step with iodoacetamide.

4.2.1 ExcelGel preparation

Two sizes of precast ExcelGel SDS gels are recommended for 2-D electrophoresis:

- ExcelGel SDS 2-D Homogeneous 12.5 (11 × 25 cm)
- ExcelGel SDS Gradient XL 12-14 (18 × 25 cm)

Both gels accept a single 24-, 18-, or 13-cm Immobiline DryStrip gel, two 11-cm, or three 7-cm Immobiline DryStrip gels. Placing shorter Immobiline DryStrip gels end-to-end is ideal for comparative studies. For maximum resolution, the larger gel coupled with the 24-cm or 18-cm Immobiline DryStrip gel is the best choice. Using the buffer strip positioner helps to get optimal results; good reproducibility is achieved because of standardized placement of Immobiline DryStrip gels and buffer strips, and a straight run because the gel surface is covered.



A flatbed second-dimension system is not recommended if the first dimension has been run on a pH 6–9, 6–11, or 7–11 NL Immobiline DryStrip gel.

Protocol

1. Equilibrate the Immobiline DryStrip gels

During the preparation of the ExcelGel SDS gel, equilibrate the Immobiline DryStrip gels as described in section 3.1.2.

2. Prepare the Multiphor II Electrophoresis System

Set the temperature on the MultiTemp III Thermostatic Circulator to 15 °C. Pipette 2.5–3.0 ml of Immobiline DryStrip Cover Fluid onto the Multiphor II cooling plate.

3. Position the ExcelGel SDS gel

Remove the gel from the foil package by cutting away the edges of the package. A notch at the lower left-hand corner of the film identifies the anodic side.

Note: The gel is cast onto a plastic support film and does not cover the film entirely. Both gel types contain a stacking gel zone with 5% acrylamide. Markings on the plastic cover indicate the direction of electrophoresis. Orient the gel according to these markings, remove the cover, and place the gel on the cooling plate. The cathodic edge of the ExcelGel SDS must align and make uniform contact with the cathodic edge of the grid on the cooling plate.



Avoid trapping bubbles between the gel and the cooling plate. Avoid getting Immobiline DryStrip Cover Fluid on the gel surface as this may cause the buffer strips to slide during electrophoresis.



Separation quality is improved if the gel surface is allowed to dry, uncovered, for approximately 5 min before proceeding.

4. Place the Multiphor II Buffer Strip Positioner

The pegs protruding from the bottom of the positioner should be in contact with the shorter sides of the cooling plate. Match the cathode (-) and anode (+) symbols on the positioner to the cathode and anode symbols on the cooling plate. Slide the positioner so that the cathodic (-) edge of the gel bisects the slot at position 1 (see instructions provided with Multiphor II Buffer Strip Positioner). Lock the positioner in place by turning the gray locking cam until the positioner cannot be moved.

5. Position the cathodic buffer strip

Carefully peel back the foil on the colorless cathodic (-) ExcelGel SDS buffer strip. Place the buffer strip with the smooth, narrow face downward. Align the buffer strip with the edge of the slot at position 1 and place it in the gel (Fig 53). If the buffer strip breaks, piece it together on the gel.

Vinyl gloves tend to stick less to the buffer strips than other types of plastic gloves. If sticking persists, dampen the gloves with distilled water or a 5% SDS solution.

6. Position the anodic buffer strip

Carefully peel back the foil on the yellow-colored (+) anodic strip and place it in the appropriate slot of the positioner:

For 11 × 25 cm ExcelGel SDS gels, place the anodic strip in slot 3, in the center of the positioner.

For 18 × 25 cm ExcelGel SDS gels, place the anodic strip in slot 4, anodic edge (+) of the positioner.

 The buffer strips should sit snugly within the slots.

4.2.2 Applying equilibrated Immobiline DryStrip gels

Protocol

1. Drain moisture from Immobiline DryStrip gels (flatbed second-dimension only)

After equilibration, place the Immobiline DryStrip gels on filter paper moistened with deionized water. To help drain the equilibration solution, place the Immobiline DryStrip gels so they rest on an edge. They can be left in this position for up to 10 min without noticeably affecting the spot sharpness. Alternatively, the Immobiline DryStrip gels can be gently blotted with moistened filter paper to remove excess equilibration buffer.

2. Position the Immobiline DryStrip gel(s)

Once the equilibrated Immobiline DryStrip gels have drained for at least 3 min, use forceps to place them gel-side down on the ExcelGel through the slot at position 2 (Fig 54). The anodic side of the IPG DryStrip should be oriented such that it is toward the front edge of the gel.



Fig 53. Positioning the anodic buffer strip on Multiphor II unit.

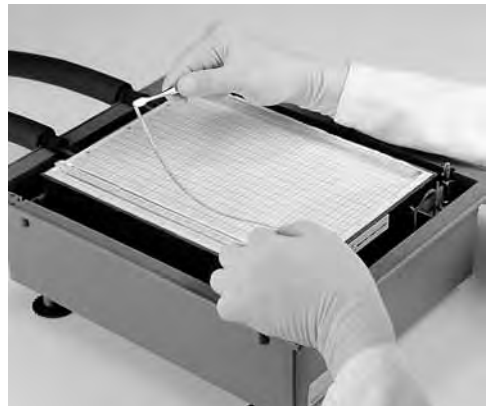

Fig 54. Positioning equilibrated Immobiline DryStrip gels on Multiphor II unit such that the anodic (acidic) side of the strip is toward the front edge of the gel.

3. Position sample application pieces

Using forceps place one IEF sample application piece at the end of each Immobiline DryStrip gel underneath the plastic "tab" formed by the overhanging gel support film at each end of the Immobiline DryStrip gel. Be sure the application pieces touch the ends of the Immobiline DryStrip gel (Fig 55).

Note: Application pieces absorb water that flows out of the Immobiline DryStrip gels during electrophoresis.

4. Ensure contact between Immobiline DryStrip gel and ExcelGel

Make sure that the Immobiline DryStrip gel is in full, direct contact with the SDS gel. To remove any bubbles, stroke the plastic backing of the Immobiline DryStrip gel gently with a spatula or forceps.

5. Optional: Apply molecular weight marker proteins

If loading marker proteins, place an extra application piece on the surface of the gel just beyond the end of the Immobiline DryStrip gel. Pipette the markers onto the extra sample application piece. Apply the markers in a volume of 15–20 μl . For less volume, cut the sample application piece proportionally. The markers should contain 200–1000 ng of each component for Coomassie staining and approximately 10–50 ng of each component for silver staining.

6. Position electrodes

Place the IEF electrode holder on the electrophoresis unit, in the upper position, and align the electrodes with the center of the buffer strips. Plug in the electrode connectors and carefully lower the electrode holder onto the buffer strips (Fig 56).

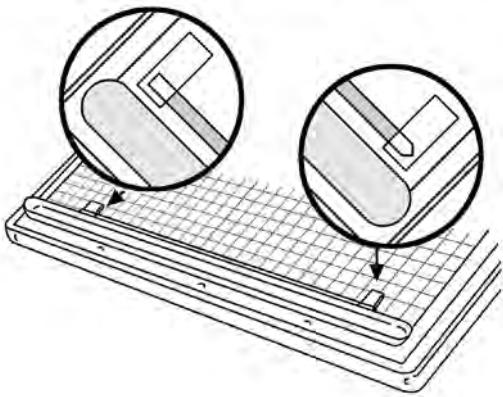

Fig 55. Positioning application pieces.



Fig 56. Positioning electrodes.

4.2.3 Electrophoresis conditions

Place the safety lid on the Multiphor II unit. Connect the power supply. Recommended electrical settings and running times are listed in Table 39.

Table 39. Electrophoresis conditions for ExcelGel gels.

	Step	Voltage (V)	Current (mA)	Power (W)	Duration (h:min)
ExcelGel SDS Homogeneous 12.5	1	120	20	30	0:40
		Open the lid and carefully remove the electrodes*			
	2	600	50	30	1:10 [†]
ExcelGel Gradient XL 12–14	1	200	20	20	0:40
		Open the lid and carefully remove the electrodes*			
	2	800	40	40	2:40 [†]

* Remove the Immobiline DryStrip gel and the application pieces. Then move the cathodic buffer strip forward to cover the area of the removed Immobiline DryStrip gel. Adjust the position of the cathodic electrode.

[†] Stop electrophoresis 5 min after the bromophenol blue front has reached the anodic buffer strip. Remove and discard the buffer strips.

4.2.4 Troubleshooting



Table 40 lists possible problems that could be encountered during second-dimension SDS-PAGE using the Multiphor II Electrophoresis System and how to solve them.

Table 40. Troubleshooting second-dimension SDS-PAGE: Multiphor II Electrophoresis System.

Symptom	Possible cause	Remedy
No current at start of run	The electrode cable is not plugged in.	Ensure that all cables are properly connected.
Dye front curves up (smiles) at one edge	Cathodic buffer strip not in contact with the gel at one edge.	Ensure that the cathodic buffer strip is centered and covers the entire width of the second-dimension gel.
Dye front curves up (smiles) at both edges	Inadequate cooling.	Ensure that the thermostatic circulator is connected to the Multiphor II unit and functioning correctly.
Dye front is irregular	Some dye front irregularity results from the use of IPG Buffer and does not affect results. Buffer strips or ExcelGel gels are old.	Ensure that the expiration dates on the buffer strips and ExcelGel gels have not elapsed.
	Bubbles under the buffer strip.	Ensure that the buffer strips are placed firmly on the gel with no air bubbles trapped beneath them.
	Bubbles under the Immobililine DryStrip gel.	Ensure that the Immobililine DryStrip gel is placed firmly on the gel with no air bubbles trapped underneath. Stroke the plastic backing of the Immobililine DryStrip gel gently with a pair of forceps to remove trapped bubbles.
Buffer strip slides out from under the electrode	Incorrect electrode placement.	Ensure that the electrodes are aligned over the center of the buffer strips before lowering the electrode holder.

5. Visualizing and evaluating results

5.0 Visualizing results—labeling and staining

Most detection methods used for SDS gels can be applied to second-dimension gels.

The following features are desirable:

- High sensitivity
- Wide linear range for quantitation
- Compatibility with mass spectrometry
- Low toxicity and environmentally friendly

However, because none of the existing techniques can meet all these requirements, a 2-D electrophoresis laboratory may need to have more than one of the following methods in its repertoire:

Autoradiography and fluorography are the most sensitive detection methods (down to 200 fg of protein). To employ these techniques, the sample must contain protein radiolabeled *in vivo* using either ^{35}S , ^{14}C , ^3H or, in the case of phosphoproteins, ^{32}P or ^{33}P . For autoradiographic detection, the gel is simply dried and exposed to X-ray film or—for quicker results and superior dynamic range of quantitation—to a storage phosphor screen. Fluorography is a technique that provides extra sensitivity by impregnating the gel in a scintillant such as PPO (2,4-diphenyloxazole) prior to drying.

Silver staining is a sensitive non-radioactive method (below 1 ng). Silver staining is a complex, multi-step process utilizing numerous reagents for which quality is critical. It is therefore often advantageous to purchase these reagents in the form of a dedicated kit, in which the reagents are quality ensured specifically for the silver-staining application. PlusOne Silver Staining Kit, Protein combines high sensitivity with ease of use.

By omitting glutaraldehyde from the sensitizer and formaldehyde from the silver nitrate solution, the method becomes compatible with mass spectrometry analysis (81), although at the expense of sensitivity.

When staining DALT precast gels with PlusOne Silver Staining Kit, Protein, a modified staining protocol should be used. For details of the modified protocol, see appendix II—Optimized silver staining of DALT precast gels using PlusOne Silver Staining Kit, Protein.

Coomassie staining, although 50- to 100-fold less sensitive than silver staining, is a relatively simple method and more quantitative than silver staining. Coomassie blue is preferable when relative amounts of protein are to be determined by densitometry. Colloidal staining methods are recommended, because they show the highest sensitivity, down to 100 ng/protein spot (82,83). See also appendix III.

Negative Zinc-Imidazole staining has a detection limit of approximately 15 ng protein/spot (85) and is compatible with mass spectrometry, but is a poor quantitation technique.

Fluorescent labeling (5) and fluorescent staining (86) provide significant advantages over Coomassie blue or silver staining. Fluorescent detection offers increased sensitivity, simple, robust staining protocols, and quantitative reproducibility over a broad dynamic range. The method is also compatible with mass spectrometry.

Deep Purple™ Total Protein Stain

Deep Purple Total Protein Stain from GE Healthcare is a fluorescent stain that provides:

- High sensitivity
- Clear, easily discernible, and accurately quantitated protein spots and bands
- High signal-to-noise ratios so low-intensity spots and bands are detected
- Compatibility with most fluorescent scanners and CCD cameras, UV transilluminators, and some light boxes
- Ease of disposal and environmental friendliness (naturally occurring fluorophore is free from heavy metals)
- Low viscosity and thus easy to handle with no oily residue

Deep Purple Total Protein Stain is compatible with downstream analysis such as MS and Edman sequencing and is ideal for post-staining gels used in 2-D DIGE analysis with Ettan DIGE system (see chapter 6).

Alternatives to Deep Purple Total Protein Stain include Sypro dyes (87–90), which have a sensitivity between colloidal Coomassie and modified staining using PlusOne Silver Staining Kit, Protein (84). Deep Purple Total Protein Stain provides superior 1-D and 2-D gel image data compared with Sypro Ruby dyes, and clearer backgrounds (see additional reading and reference material).

Refer to appendix IV for the protocol for use of Deep Purple Total Protein Stain.

Figure 57 shows 2-D gels stained with Sypro Ruby and Deep Purple Total Protein Stain.

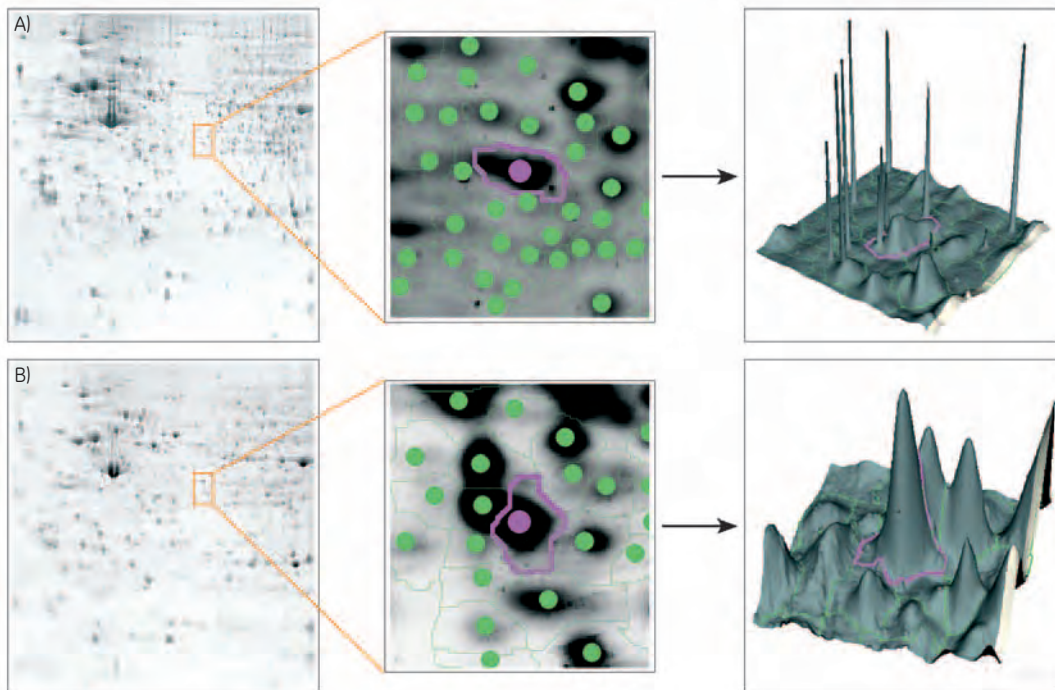



Fig 57. 2-D gels of a protein sample consisting of a mix of HBL100 breast cell line and BT474 breast cell carcinoma stained with (A) Sypro Ruby and (B) Deep Purple Total Protein Stain. For clarity, the gel images show pH 3–8 where most of the proteins are present. The expanded region of the gel stained with Sypro Ruby (gel A) and resulting 3-D plot demonstrate the drawbacks associated with “speckling”. Staining with Deep Purple Total Protein Stain (gel B) eliminates speckling and improves spot clarity, which allows more accurate spot detection and protein identification. First dimension: pH 3–10 NL 24-cm Immobiline DryStrip strip run on Ettan IPGphor 3 IEF System; second dimension: 12.5% SDS electrophoresis gel run on Ettan DALTwelve electrophoresis system. Scanned using Typhoon 9410 Variable Mode Imager. Full experimental details can be found in application note 18-1177-44.

 The plastic backing on precast gels can pose a problem of high background when fluorescent staining and labeling techniques are used.

5.0.1 Automating processing and preserving the gel

Processor Plus automates multistep staining processes for increased convenience and reproducibility. Automated protocols have been developed to use PlusOne Silver Staining Kit, Protein to silver stain proteins in SDS gels. This convenient adaptation gives reproducible results and sensitivity below 1 ng per spot for most proteins. With a modification for subsequent mass spectrometry, detection down to approximately 5 ng per spot can be achieved (84). For further information regarding methodology, please refer to the Processor Plus Protocol Guide (see additional reading and reference material).

Staining Tray Set provides a convenient means of staining up to four large-format gels at a time—film-backed, as well as unbacked. The set includes two stainless steel trays and a perforated stainless steel tray, which seats within the staining trays, and a transparent plastic cover. The perforated insert supports and restrains gels for transfer between staining trays while allowing staining solution to drain rapidly.

The film-supported DALT and ExcelGel precast gels are optimally stored in sheet protectors after soaking them in 10% v/v glycerol for 30 min. Unbacked gels are shrunk back to their original sizes by soaking them in 30% (v/v) methanol or ethanol/4% glycerol until they match their original sizes. For autoradiography the gels are dried onto strong filter paper with a vacuum dryer.

5.1 Blotting

Second-dimension gels can be blotted onto a nitrocellulose or polyvinylidene difluoride (PVDF) membrane for immunochemical detection of specific proteins or for chemical microsequencing.

GE Healthcare offers a range of blotting membranes and equipment for such purposes. Hybond™-ECL™ is an unsupported, 100% pure nitrocellulose membrane that has been validated for use with ECL Western Blotting System and for all radioactive, non-radioactive, and chromogenic protein blotting applications. It has excellent sensitivity, resolution, and low background. Hybond-P is a PVDF membrane optimized for use in protein transfers. It has higher mechanical strength than unsupported nitrocellulose and a protein binding capacity of 125 µg/cm². Hybond-P is chemically stable, allowing the use of a range of solvents for rapid de-staining.



The plastic backing on DALT and ExcelGel precast gels is removed with the Film Remover prior to electrotransfer (see ordering information).

5.2 Evaluating results

In theory, the analysis of up to 15 000 proteins should be possible in one gel; in practice, however, 5000 detected protein spots means a very good separation. Evaluating high-resolution 2-D gels by a manual comparison of two gels is not always possible. In large studies with patterns containing several thousand spots, it may be almost impossible to detect the appearance of a few new spots or the disappearance of single spots. Image collection hardware and image evaluation software are necessary to detect these differences as well as to obtain maximum information from the gel patterns.

ImageMaster™ 2D Platinum and DeCyder™ 2-D Differential Analysis software, together with ImageScanner™ and/or Typhoon multicolor fluorescence and phosphor image scanner, comprise a system that allows the user to capture, store, evaluate, and present information contained in 2-D gels:

- ImageScanner II desktop instrument captures optical information in the visible wavelength range over a range from 0 to more than 3.4 O.D. in reflection or transmission mode. It scans 20 × 20 cm in 40 s at 300 dpi.
- Typhoon 9400 Variable Mode Imager has red-, green-, and blue-excitation wavelengths and a wide choice of emission filters that enable imaging of a variety of fluorophores.

Typhoon series imagers can be used for high-performance four-color automated fluorescence detection making them ideal for use with the three-dye system employed in 2-D DIGE analysis with Ettan DIGE system. In addition, Typhoon 9400 series imagers perform storage phosphor imaging and chemiluminescence imaging. Comprehensive information on fluorescence imaging can be found in the GE Healthcare handbook: Fluorescence imaging, principles, and methods (see additional reading and reference material).

- ImageMaster 2D Platinum is a high-throughput 2-D imaging software for almost parameter-free spot detection. No manual spot editing is required, resulting in maximum reproducibility of evaluation results. Matching is based on spot features rather than simply spot positions. A wide selection of statistical tools enables the user to extract the relevant information in a minimum of time, with maximum confidence.
- DeCyder 2-D Differential Analysis Software has been specifically developed as a key element of the Ettan DIGE system and is described further in chapter 6.

In addition to these products, Personal Densitometer™ SI is also available. Personal Densitometer is a highly sensitive, laser-based transmission densitometer with a linear range of 0.1–3.5 OD, that can quantitate colorimetrically stained gels.

5.3 Standardizing results

2-D electrophoresis is often used comparatively, and thus requires a reproducible method for determining relative spot positions. Because precast Immobiline DryStrip gels are highly reproducible, the pI of a particular protein can be estimated from its focusing position along a linear pH gradient Immobiline DryStrip gel. Detailed information on Immobiline DryStrip pH gradients are found in the publication Immobiline DryStrip visualization of pH gradients (see additional reading and reference material).

The second dimension can be calibrated using molecular weight marker proteins loaded to the side of the second-dimension gel. Often, there are abundant proteins in the sample for which the pI and molecular weight are known. These proteins can serve as internal standards.



The pI of a protein is dependent on its chemical environment and can thus vary depending on the experimental conditions used. The use of native pI markers is not recommended because they will run differently in a native environment compared with a denaturing environment (e.g. urea).

5.4 Further analysis of protein spots

The procedure of picking and digesting spots can be performed manually or semi-automatically by manual transfer of gels and microplates between the instruments as described below, or fully automatically in the integrated Ettan Spot Handling Workstation.

Ettan Spot Handling Workstation comprises a stand-alone, controlled-atmosphere cabinet containing a spot picker/spotter, digester, incubator, dryer, microplate hotel that also stores gel trays and MS targets, and robot for transferring samples between the modules.

A computer with proprietary software controls the whole process. As an option, the processing in Ettan Spot Handling Workstation can be integrated into Sierra™ Laboratory Workflow System (LWS), a communication platform for the entire 2D-MS workflow. This software compiles and handles information, from receipt of samples, through gel electrophoresis and processing in the workstation to information analysis and reporting. Communication and information transfer from Ettan Spot Handling Workstation to Sierra LWS is completely automated.

5.4.1 Picking protein spots

Ettan Spot Picker is a robotic system that automatically picks selected protein spots from stained or destained gels using a pick list created from the image analysis software, and transfers them into microplates.

DALT precast gels or lab-cast gels are stained with Coomassie, silver, or fluorescent dyes and two visible reference markers are attached to each gel. The gels are scanned using ImageScanner or Typhoon and analyzed using ImageMaster 2D Platinum or DeCyder 2-D Differential Analysis Software. The positions of selected protein spots are exported as a pick list to Ettan Spot Picker. The gels are placed into the instrument under liquid and the camera detects the reference markers. Control software converts spot pixel co-ordinates into picking co-ordinates, and the Ettan Spot Picker selects and transfers gel plugs into 96-well microplates.

5.4.2 Digesting proteins and spotting onto MALDI-ToF MS slides

The gel plugs are digested in Ettan Digester, the supernatant peptides are mixed with matrix-assisted laser desorption ionization time of flight mass spectrometry (MALDI-ToF MS) matrix material, and spotted onto MALDI-ToF MS slides using Ettan Spotter.

5.4.3 MALDI-ToF mass spectrometry

Time-of-flight mass spectrometry is a technique for analyzing molecular weights based on the motion of ionized samples in an electrical field. In Ettan MALDI-ToF Pro mass spectrometer, a matrix-bound sample is bombarded with a pulsed laser beam to generate ions for subsequent detection. Ettan MALDI-ToF Pro provides fast and precise identification of proteins in high-throughput peptide mass fingerprinting (PMF).

The novel quadratic field reflectron (Z^2 reflectron) technology in Ettan MALDI-ToF Pro offers single run, post-source decay (PSD) data acquisition in approximately 1 min. Automated database searching of PSD data allows rapid and precise protein identification from single tryptic peptides.

In cases where PMF cannot provide unambiguous protein identification, reliable information can be obtained by using the instrument in conjunction with CAF MALDI Sequencing Kit. Chemically assisted fragmentation (CAF) used in conjunction with MALDI MS is a method for improving fragmentation of tryptic peptides by PSD. The technique introduces a negative charge at the amino terminus of the peptide. Following fragmentation, only y ions (containing C termini) are acquired in the spectra, while the neutralized b ions (containing N termini) are not observed. The spectra containing y ions are easy to interpret and amino acid sequences can be deduced by calculating the mass differences between the fragmented ions.

The software for automated PSD analysis has automated PSD data acquisition of selected peaks and automated PSD spectrum processing and identification. This enables rapid and sensitive peptide sequencing and protein identification.

Chemically assisted fragmentation MALDI simplifies the amino acid sequencing of peptides and identification of phosphorylation sites.

6. 2-D Fluorescence Difference Gel Electrophoresis (2-D DIGE)

6.0 Overview

2-D Fluorescence Difference Gel Electrophoresis (2-D DIGE) is a method that labels protein samples prior to 2-D electrophoresis, enabling accurate analysis of differences in protein abundance between samples (86). It is possible to separate up to three different samples within the same 2-D gel (Fig 58). The technology is based on the specific properties of spectrally resolvable dyes, CyDye DIGE Fluor dyes. Two sets of dyes are available—Cy™2, Cy3, and Cy5 minimal dyes, and Cy3 and Cy5 saturation dyes—that have been designed to be both mass- and charge-matched. As a consequence, identical proteins labeled with each of the CyDye DIGE Fluor dyes will migrate to the same position on a 2-D gel. This ability to separate more than one sample on a single gel permits the inclusion of up to two samples and an internal standard (internal reference) in every gel. The internal standard is prepared by mixing together equal amounts of each sample in the experiment and including this mixture on each gel.

CyDye DIGE Fluors are:

- Size- and charge-matched. The same labeled protein from different samples will migrate to the same position, regardless of the dye used.
- pH insensitive. No change in signal over the wide pH range used during first-dimension separation (IEF) and equivalent migration in SDS gels.
- Spectrally resolvable. The distinct signal from each fluor contributes to the accuracy.
- Highly sensitive and bright.
- Photostable. There is minimal loss of signal during labeling, separation, and scanning.

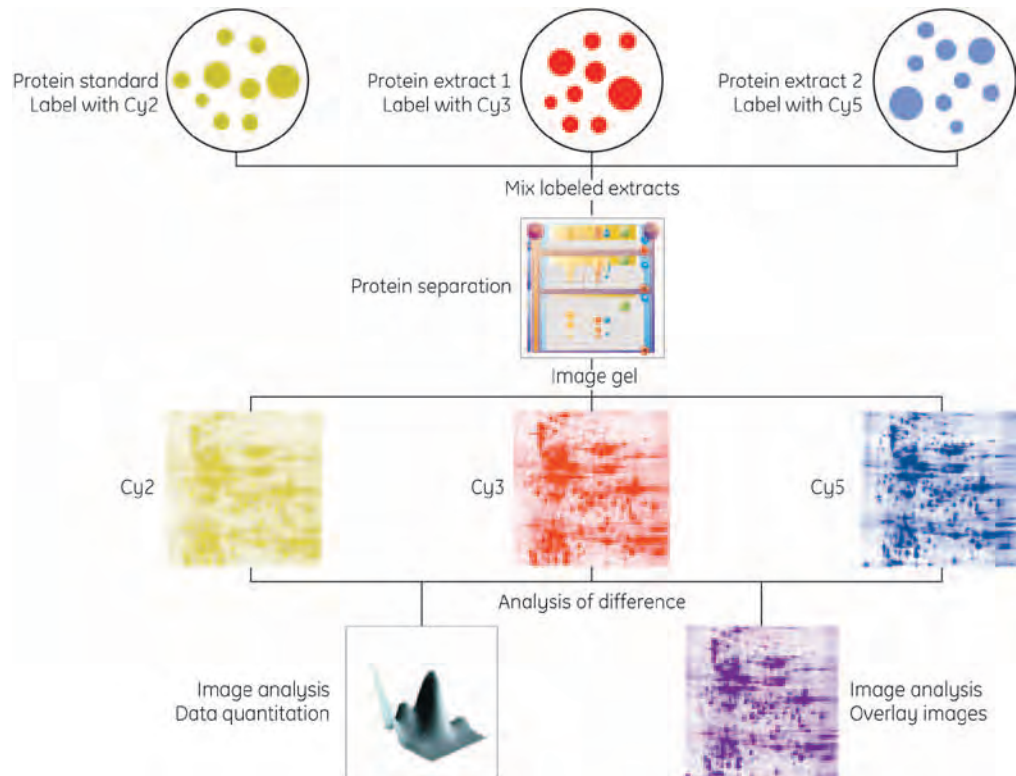

Fig 58. Multiplexing using the CyDye DIGE Fluor minimal dye option with Ettan DIGE system.

CyDye DIGE Fluors are available as minimal and saturation labeling dyes. The minimal dyes are intended for general 2-D application use where sufficient amounts of sample are available. The saturation dyes, included in the scarce sample and preparative gel labeling kits, are designed to be used for applications where only small amounts of sample are available, for example in Laser Capture Microdissection.

Ettan DIGE system capitalizes on the ability to multiplex by combining CyDye DIGE Fluor dyes with DeCyder 2-D Differential Analysis Software. DeCyder 2-D software has been designed specifically for Ettan DIGE applications. It utilizes a proprietary co-detection algorithm that permits automatic detection, background subtraction, quantitation, normalization, and inter-gel matching of the fluorescent images. The use of an internal standard gives an increased confidence that the results reflect true biological effects and are not due to system variation.

The system comprises CyDye DIGE Fluor dyes for protein labeling; a choice of Ettan IPGphor 3 Isoelectric Focusing System or Multiphor II Electrophoresis System for first-dimension separation; Ettan DALTsix, DALTwelve, or SE 600 Ruby vertical electrophoresis systems for second-dimension separation; Typhoon Variable Mode Imager for advanced imaging; and DeCyder 2-D Differential Analysis Software for quantitation and statistical analysis of protein differences over a linear dynamic range of up to four orders of magnitude. Figure 59 summarizes the steps in the analysis.

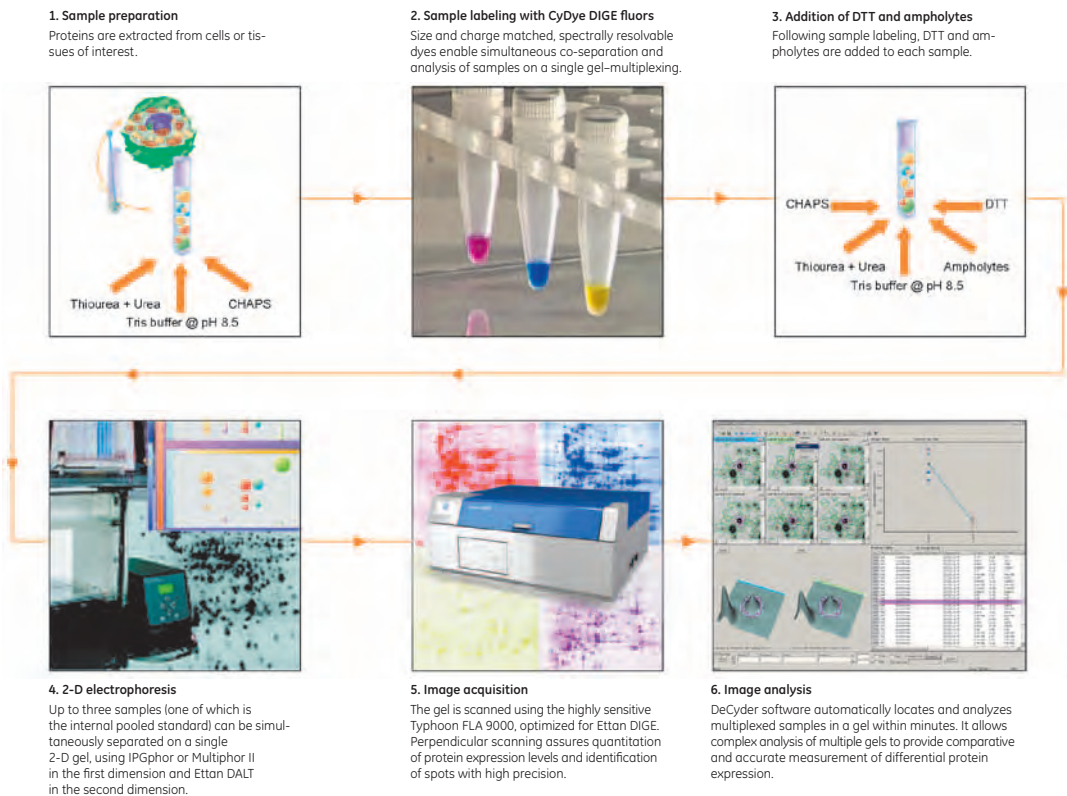
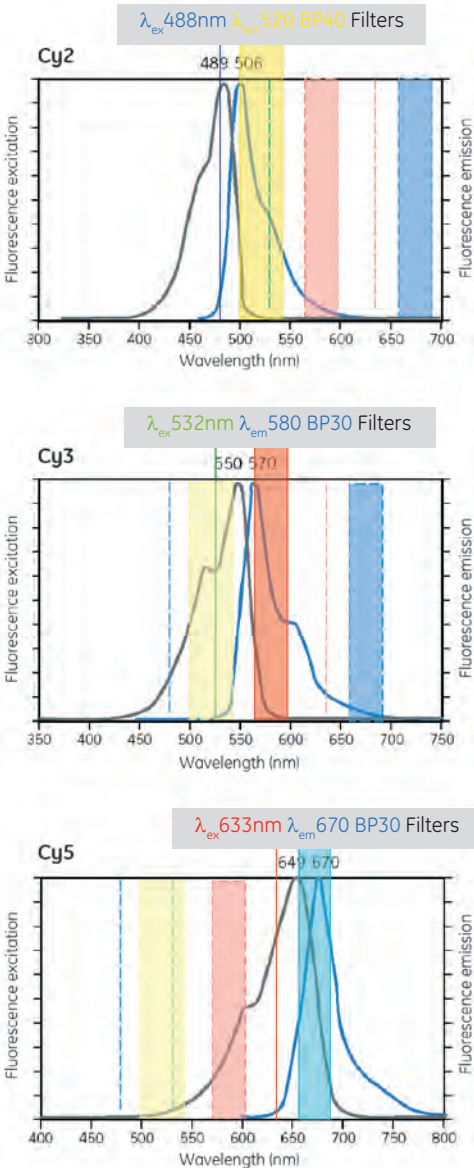

Fig 59. Ettan DIGE system for protein analysis. Protein samples are extracted (1) and labeled with CyDye DIGE Fluor minimal dyes in the absence of DTT and ampholytes (2). These are added following the labeling reaction (3). The fluors enable up to two samples plus an internal standard to be resolved on the same 2-D gel (4). Gel images are obtained from the Typhoon Variable Mode Imager, which has been optimized for use with CyDye DIGE Fluor minimal dyes (5). The images are automatically analyzed within DeCyder 2-D Differential Analysis Software (6).

6.1 CyDye DIGE Fluor dyes

6.1.1 CyDye DIGE Fluor minimal dyes

CyDye DIGE Fluor minimal dyes consist of three bright, spectrally resolvable fluors (Cy2, Cy3, and Cy5) that are matched for mass and charge. The fluors offer great sensitivity, detecting as little as 125 pg of transferrin and giving a linear response to protein concentration of up to four orders of magnitude. In comparison, silver stain detects 1-60 ng of protein with less than a hundred-fold dynamic range (90, 91). Narrow excitation and emission bands mean that the CyDye Fluor minimal dyes are spectrally distinct, which makes them ideal for multi-color detection (Fig 60). Most importantly, the fluors are mass- and charge-matched so that the same protein labeled with any of the CyDye DIGE Fluor minimal dyes will migrate to the same position within a 2-D gel (92-94). The novel properties of the CyDye DIGE Fluor minimal dyes make them ideal for multiplexing different protein samples within the same 2-D gel. This permits inclusion of an internal standard within each gel, which limits experimental variation and ensures accurate intra- and inter-gel matching.



Black curve, excitation; blue curve, emission for each of the dyes. The numbers at the top of each curve indicate the maxima.
 // Cy2 excitation wavelength; // Cy3 excitation wavelength;
 // Cy5 excitation (excitation wavelength = $\lambda_{em} \pm 0.1$ nm);
 ■ Cy2 emission filter; ■ Cy3 emission filter; ■ Cy5 emission filter.
 Filters: the values for each of the excitation and emission filters for each dye are chosen to minimize cross-talk, BP40: bandpass of $40 = \lambda_{em} \pm 20$ nm; BP30: bandpass of $30 = \lambda_{em} \pm 15$ nm.

Fig 60. Excitation and emission spectra of CyDye DIGE Fluor minimal dyes Cy2, Cy3, and Cy5 showing the excitation and emission filters.

6.1.2 Minimal labeling of protein with CyDye DIGE Fluor minimal dyes

CyDye DIGE Fluor minimal dyes contain an N-hydroxysuccinimidyl ester reactive group. This enables labeling of lysine residues within proteins, forming a covalent bond with the epsilon amino group of lysine residues to yield an amide linkage (Fig 61). The recommended concentration of fluor present in a protein labeling reaction ensures that the fluor is limiting. This leads to the labeling of approximately 1–2% of lysine residues. As a result, CyDye DIGE Fluor minimal dyes will label only a small proportion of each protein in a sample, hence the expression “minimal labeling.”

The lysine amino acid in proteins carries an intrinsic positive charge which, when a CyDye DIGE Fluor minimal dye is coupled to the lysine, replaces the lysine's single positive charge with its own, ensuring that the pI of the protein does not change.

When coupled to the protein, CyDye DIGE Fluor minimal dyes add approximately M_r 500 to the protein's mass. However, proteins should not be picked using the CyDye-labeled gel image as a positional reference due to slight migration differences between the unlabeled and labeled proteins. These differences are due to the addition of a single CyDye molecule to the labeled protein, which decreases the mobility of the protein with respect to unlabeled protein. This effect is more marked for lower-molecular-weight proteins.

To ensure that the majority of unlabeled protein is picked, and therefore that sufficient protein is available for identification by mass spectrometry, any gel for picking (usually a preparative gel) can be post-stained with a suitable stain such as Deep Purple (see section 5.0 and appendix IV). The resulting gel is matched to the analytical set of DIGE gels within the DeCyder 2-D Differential Analysis Software.

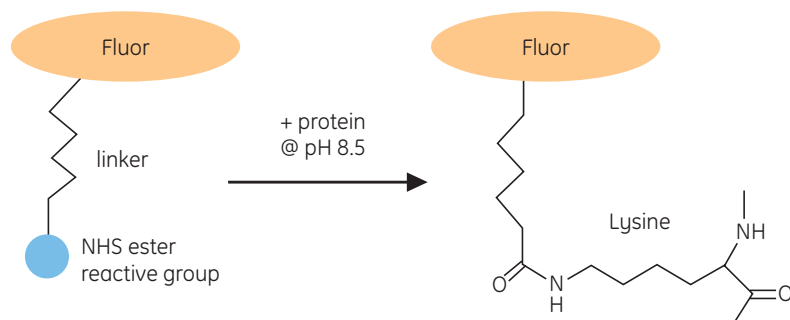

Fig 61. Schematic of the labeling reaction. CyDye DIGE Fluor containing NHS-ester active group covalently binds to lysine residue of protein via an amide linkage.

Minimal labeling of proteins does not affect the mass spectrometry data used to identify proteins because only 1–2% of lysine residues are labeled, such that 98% of protein is unlabeled.

6.2 CyDye DIGE Fluor labeling kits with saturation dyes for labeling scarce samples and preparative gels

Two labeling kits for scarce samples are available; one contains the Cy3 and Cy5 saturation dyes and the other contains an additional vial of Cy3 dye to label a preparative gel. Each kit contains sufficient dye for at least 12 labeling reactions and allows labeling of as little as 5 μg of protein per labeling reaction, compared with 50 μg with the minimal dyes. The additional vial of Cy3 dye contained in the CyDye DIGE Fluor Labeling Kit for Scarce Samples and Preparative Gel Labeling allows for labeling up to 500 μg of protein. The saturation dyes Cy3 and Cy5 retain the advantages described in section 6.1 for the minimal dyes.

The maleimide reactive group of the saturation dyes covalently bonds to the thiol group of cysteine residues of proteins via a thioether linkage. To achieve maximal labeling of cysteine residues, the protocol uses a high fluor to protein labeling ratio. This type of labeling method labels all available cysteines on each protein under the conditions used, resulting in the majority of cysteine groups in a protein from a sample being labeled. For this reason, the method has been called “saturation labeling.” See Figure 62 for an overview of the workflow and Figure 63 for a diagram of the labeling process.

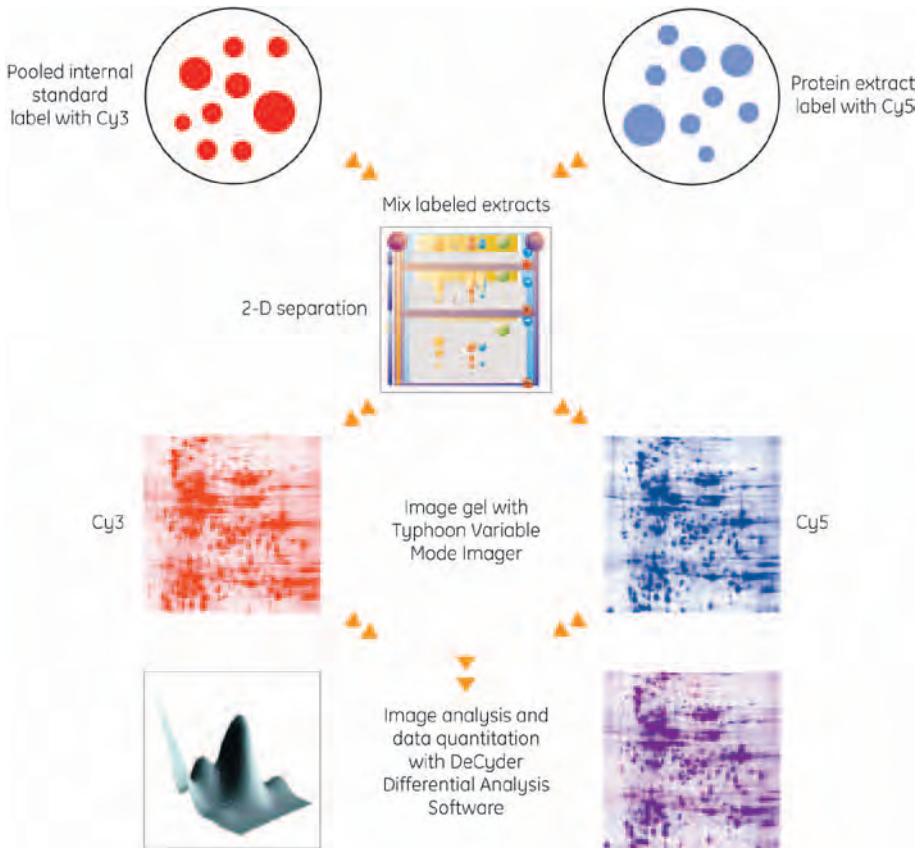

Fig 62. Outline of the Ettan DIGE system workflow for saturation labeling.

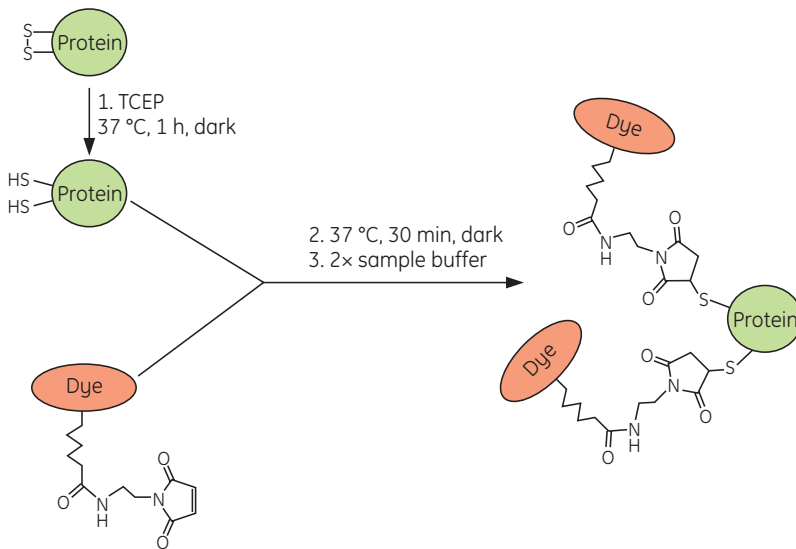

Fig 63. Schematic of labeling reaction between CyDye DIGE Fluor saturation dye and the cysteine residues of a protein.

6.3 Ettan DIGE system workflow

The main steps in the Ettan DIGE system workflow are outlined in Figure 64.

There are several key differences between standard 2-D electrophoresis and Ettan DIGE system experiments. Failure to incorporate these changes into an Ettan DIGE system experiment will impact upon data quality. See Table 41 for these differences.

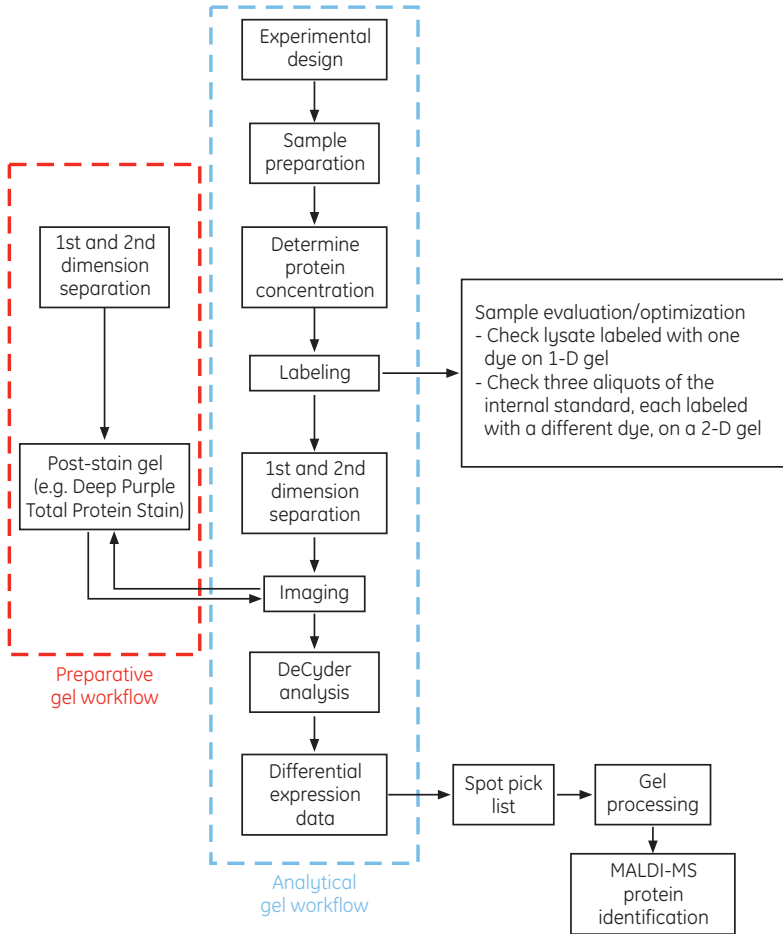

Fig 64. Ettan DIGE system workflow.

6.3.1 Experimental design for Ettan DIGE system applications

The differences in methodology between 2-D DIGE and traditional 2-D electrophoresis are outlined in Table 41.

Table 41. Differences in methodology between 2-D DIGE and traditional 2-D electrophoresis.

Step	2-D DIGE	Traditional 2-D electrophoresis
Sample preparation	Exclude carrier ampholyte and reductant until after labeling.	Carrier ampholyte and reductant included.
	Concentrate protein to 1–10 mg/ml.	Concentration of sample is optional.
Labeling	Addition of CyDye required.	No CyDye required.
	Labeling reaction terminated with addition of lysine.	No lysine addition required.
2× sample buffer (added to sample after labeling)	The sample buffer is made with 2× concentration of reductant and carrier ampholyte. (An equal volume of this buffer is added to the labeled proteins.) See the protocol in section 6.3.4.	Not required.
Electrophoresis	Use low-fluorescence glass plates.	Use standard glass plates.

Traditional 2-D electrophoresis suffers from two main types of variation:

System variation may arise due to differences in electrophoretic conditions between different gels, user-to-user variation, or poor performance of the image analysis software. This variation can be controlled by the inclusion of an internal standard within each gel and has also been minimized by development of the co-detection algorithm within DeCyder 2-D Differential Analysis Software.

Inherent biological variations are differences that arise between different individuals, cell cultures, etc. These cannot be removed from the analysis but can be accurately measured, and therefore differentiated from the system variation. Inherent biological variation must be considered if genuine, induced biological changes (biologically significant changes that arise as a consequence of the test conditions) are to be identified. It is strongly advised that biological replicates (such as multiple cultures) be incorporated into the experimental design. The more biological replicates included in the experiment, the more likely that inherent biological variation is taken into account, enabling a reliable measure of significant induced biological change. Since the system variation with Ettan DIGE system is low due to the internal standard and analysis method, biological variation will far exceed the system variation, and gel replicates are therefore not necessary.

Experimental setup

To maximize the benefits of Ettan DIGE system, an internal standard should be incorporated within each gel. The ideal internal standard comprises pooled aliquots from all the biological samples within the experiment. The internal standard is labeled with one CyDye DIGE Fluor minimal dye (e.g. Cy2) and is run on every gel together with experimental samples labeled with Cy3 or Cy5 CyDye DIGE Fluor minimal dyes (Table 42). This ensures that every spot on every gel is represented within the common internal standard. Each protein spot in a sample can therefore be compared with its representative within the internal standard to generate a ratio of relative expression (Fig 65).

Experimental design for using the two saturation dyes from the CyDye DIGE Fluor Labeling Kit for Scarce Samples and Preparative Gel Labeling is simple: one dye is selected to label the internal standard (e.g. Cy3) and the other to label the individual samples in the experiment.

Gel 1

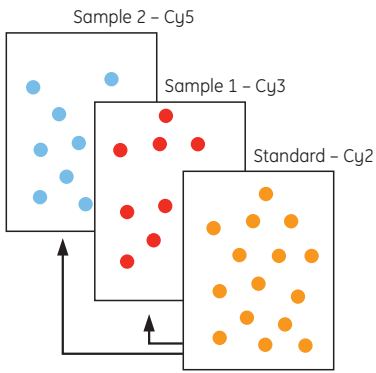

Protein N (sample 1) : Protein N (standard gel 1)
Protein N (sample 2) : Protein N (standard gel 1)

Gel 2

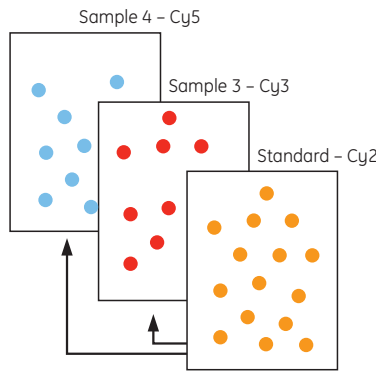

Protein N (sample 3) : Protein N (standard gel 2)
Protein N (sample 4) : Protein N (standard gel 2)

Fig 65. Quantitation of protein abundance using co-detection algorithms. From each gel, three scan images are generated, Cy2 for the internal standard, and Cy3 or Cy5 for test samples. The protein abundance of each spot in each sample is expressed as a normalized ratio relative to spots from the in-gel internal standard.

The same internal standard is run on all gels within the experimental series. This creates an intrinsic link between internal standard and samples in each gel, matching the internal standards between gels. Quantitative comparisons of samples between gels are made based on the relative change of sample to its in-gel internal standard. This removes inter-gel variation, a common problem associated with traditional 2-D, and separates gel-to-gel variation from biological variation (Fig 66), enabling accurate, statistical quantitation of induced biological change between samples. Ettan DIGE system is currently the only protein difference analysis technique to utilize this approach (95).

Gel 1

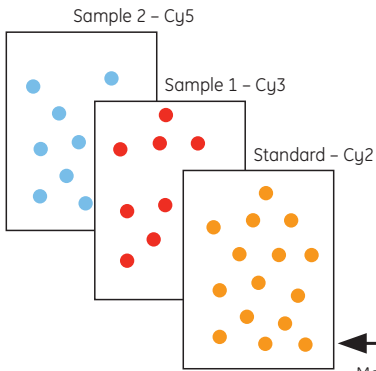

Gel 2

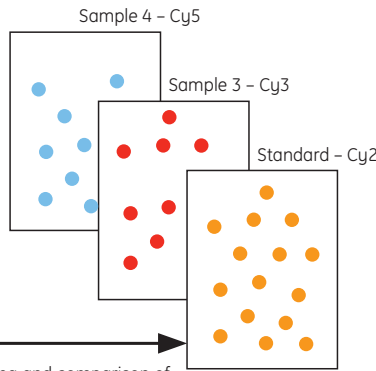

Matching and comparison of samples using the relative measure of sample to standard

Protein N in (sample 1) : (sample 2) : (sample 3) : (sample 4)

Fig 66. Matching and comparison of samples across gels. The internal standard sample, present on every gel, is used to aid matching of spot patterns across all gels. The relative ratios of individual sample spots to their internal standards are used to accurately compare protein abundance between samples on different gels.

The advantages of linking every sample in-gel to a common standard are:

- Accurate quantitation and accurate spot statistics between gels
- Increased confidence in matching between gels
- Flexibility of statistical analysis depending on the relationship between samples
- Separation of system variation from biological variation

Table 42 shows an example of a recommended experimental setup that was designed to derive statistical data on differences between control and three treatment regimens A, B, and C. For the control and each treatment regimen, four biological replicates were included. The internal standard (a pool of all samples: four control and 12 treated) was labeled with CyDye DIGE Fluor Cy2 minimal dye and run on every gel.

Table 42. Setup for an Ettan DIGE system experiment.

Gel number	Cy2	Cy3	Cy5
1	Pooled standard	Control 1	Sample A3
2	Pooled standard	Sample A1	Sample B3
3	Pooled standard	Sample B1	Sample C3
4	Pooled standard	Sample C1	Control 3
5	Pooled standard	Control 2	Sample B4
6	Pooled standard	Sample A2	Sample C4
7	Pooled standard	Sample B2	Control 4
8	Pooled standard	Sample C2	Sample A4

Each gel contains CyDye DIGE Fluor Cy2 minimal dye-labeled standard, which is a pool of aliquots taken from each sample. Four biological replicates (1–4) have been included for control and treated (A, B, or C) samples. The samples have been arranged between gels to ensure an even distribution between those labeled with CyDye DIGE Fluor Cy3 minimal dye and those labeled with CyDye DIGE Fluor Cy5 minimal dye. This setup avoids repeatedly linking the same two treatment types on multiple gels. For further information relating to experimental design, please refer to the Ettan DIGE user manual.

6.3.2 Sample preparation for Ettan DIGE system applications

CyDye DIGE Fluor minimal dyes, used for protein labeling in Ettan DIGE system applications, form a peptide linkage between the fluor and lysine residues within the protein. Components such as primary amines (e.g. ampholytes) will compete with the proteins for fluor binding. Thiols (e.g. DTT) also cause a reduction in labeling efficiency. The result will be fewer fluor-labeled proteins, which may affect the data after scanning and spot detection. To achieve optimal labeling, such components should be omitted from both the lysis and sample buffers and are only added to the sample after labeling.

The labeling reaction with CyDye DIGE Fluor minimal dyes is most efficient at pH 8.5. Below pH 8.0, reactivity of the label is reduced; above pH 9.0, increased non-specific binding to thiol groups is promoted and the NHS ester may become inactivated due to hydrolysis. Lysis and sample solutions should be buffered using NaOH to pH 8.5.

CyDye DIGE Fluor saturation dyes, included in the labeling kits for scarce samples and preparative gels, covalently bind to the thiol group of cysteine residues via a thioether linkage. The labeling reaction with CyDye DIGE Fluor saturation dyes is most efficient at pH 8.0.

For further information on compatible reagents for labeling, please refer to appendix E.2 of the Ettan DIGE user manual.

Protocol for preparing protein from cell cultures and then labeling with CyDye DIGE Fluor minimal dyes

A. Washing cells

If using a cell culture, wash cells to remove any growth media or reagents that might affect the CyDye DIGE Fluor minimal dye labeling process. Check that the cell wash buffer does not contain any primary amines or thiols that may interfere with the downstream labeling process.

DIGE cell washing buffer contains 10 mM Tris pH 8.0, 5 mM magnesium acetate.

DIGE cell lysis buffer contains 30 mM Tris, 2 M thiourea, 7 M urea, 4% CHAPS (w/v) at pH 8.5.

B. Lysing cells in lysis buffer

1. Resuspend the washed cell pellet in 1 ml of DIGE cell lysis buffer at pH 8.5 and leave on ice for 10 min (approximately 4×10^{10} E. coli cells will yield 5–10 mg protein).
2. Lyse cells (see section 1.1) on ice until solution becomes less cloudy.
3. Centrifuge to pellet cell debris.

4. Transfer supernatant into a tube and if necessary adjust to pH 8.5.
5. Determine protein concentration. For best results the sample concentration should be 1–10 mg/ml.

For further information relating to sample preparation, please refer to the Ettan DIGE user manual.

If working with a sample in an unknown buffer, the sample should be precipitated and resuspended in an Ettan DIGE system-compatible buffer. 2-D Clean-Up Kit can be used for this purpose (see section 1.4.1).

6.3.3 Sample labeling with minimal dyes for Ettan DIGE system applications

With CyDye DIGE Fluor minimal dyes, it is important that primary amines (e.g. ampholytes) and thiols (e.g. DTT) are excluded from the sample until after labeling with the dyes has been completed.

For best results the sample concentration should be 1–10 mg/ml (5 mg/ml is optimal). For efficient labeling, the pH of the labeling reaction should be between 8.0 and 9.0 (pH 8.5 is optimal).

A. Preparation of CyDye DIGE Fluor minimal dyes for protein labeling

The dimethylformamide (DMF) used to reconstitute the fluors should be high-quality anhydrous ($\leq 0.005\% \text{ H}_2\text{O}$, $\geq 99.8\%$ pure). It must not become contaminated with water, which will start to degrade the DMF to amine compounds. The DMF stock solution should be replaced at least every 3 months.



Use of molecular sieves will help keep DMF in an anhydrous condition.

Condensation should be prevented from forming within the fluor vials. Once removed from the freezer, the fluor tubes should be left for 5 min to equilibrate to room temperature prior to opening.

Although CyDye DIGE Fluor minimal dyes and labeled proteins are very photostable, the fluors and labeled proteins should be kept covered or in the dark.

1. Reconstitute CyDye DIGE Fluor minimal dyes

Once the fluors have equilibrated to room temperature, dispense the specified volume of DMF into the fluor vial to achieve a concentration of 1 nmol/ μl (see specification sheet supplied with the fluor), e.g. add 25 μl DMF to 25 nmol of fluor. Mix vigorously and centrifuge to collect fluor at the bottom of the vial. The concentrated stock solution is stable for two months at $-20\text{ }^\circ\text{C}$ or until the expiry date if sooner.

2. Dilute CyDye DIGE Fluor minimal dyes to a working stock concentration

Dilute the concentrated stock solutions to a working fluor concentration of 400 pmol/ μl using DMF, e.g. add 2 μl of concentrated stock fluor to 3 μl of DMF.

The working fluor solution is stable for one week at $-20\text{ }^\circ\text{C}$ or until the expiry date if sooner.

B. Labeling protein sample with CyDye DIGE Fluor minimal dyes.

A pooled internal standard should be created from all of the samples. This will need to be sufficient for inclusion on every gel.

It is recommended that the ratio of protein to fluor is maintained at 50 μg protein to 400 pmol fluor. However, it may be necessary to determine the optimum ratio for individual samples.

1. Label proteins

Add 1 μl of working fluor solution (400 pmol/ μl) to a volume of sample containing 50 μg of protein. Mix thoroughly by vortexing. Centrifuge to collect labeling mixture at the bottom of the tube. Incubate on ice for 30 min in the dark.

2. Quench the labeling reaction

Add 1 μl of 10 mM lysine to stop the labeling reaction. Mix well and leave on ice for 10 min in the dark.

3. Store sample

The labeled sample can either be processed immediately or stored for up to three months at $-70\text{ }^\circ\text{C}$ in the dark.

To confirm efficient labeling, any new protein samples should be labeled with CyDye DIGE Fluor Cy5 minimal dye and run on a 1-D SDS-PAGE gel to compare the efficiency of labeling against a control lysate already known to label successfully. A lysate of known concentration in an Ettan DIGE system-compatible lysis buffer would be a suitable alternative control.

6.3.4 Two-dimensional separation of protein samples

Separation of labeled proteins is carried out using traditional 2-D polyacrylamide gel electrophoresis (see chapters 2–4).

Protocol

A. Combining protein samples for multiplexing

Protein samples labeled with different CyDye DIGE Fluor minimal dyes are combined according to the experimental design (see section 6.3). For best results, one or two labeled protein samples (usually Cy3 or Cy5) are combined with a labeled internal standard (usually Cy2), which is a pool of aliquots of all biological samples in the experiment.

B. Diluting labeled protein sample in sample buffer

The sample mixture is diluted further in sample buffer prior to separating the individual proteins on a 2-D gel.

Ettan DIGE system-compatible 2× sample buffer contains 7 M urea, 2 M thiourea, 2% CHAPS (w/v), 2% IPG buffer or Pharmalyte (v/v) for IEF, 2% DTT (w/v).

Add 1 volume of 2× sample buffer to sample. Mix and leave on ice for at least 10 min.

C. Rehydrating Immobiline DryStrip gel

Refer to sections 2.4–2.7 for a discussion of rehydration and sample application methods.

Ettan DIGE system-compatible rehydration buffer contains 7 M urea, 2 M thiourea, 4% CHAPS (w/v), 1% IPG buffer or Pharmalyte (v/v) for IEF, 2% (w/v) DTT.

D. Separating proteins in the first dimension

Ettan IPGphor 3 Isoelectric Focusing System and Multiphor II Electrophoresis System are both suitable for Ettan DIGE system applications. Detailed instructions for use of the systems are given in chapters 2 and 4, respectively. Ettan DIGE applications are described in detail in the Ettan DIGE user manual.

E. Separating proteins in the second dimension

Low-fluorescence glass plates must be used for gels used in Ettan DIGE system. Standard glass or plastic-backed plates can result in the generation of a high background signal.

DIGE Gel is a 12.5% precast, low-fluorescent polyacrylamide gel cast in a low-fluorescent glass cassette specially developed for 2-D DIGE analysis. DIGE Gel should be used with the DIGE Buffer Kit, which consists of concentrated running buffers and Sealing Solution for attaching Immobiline DryStrip Gels (IPG strips) to the top of the polyacrylamide gel. The capacity of the buffer system is similar to the commonly used Laemmli (Tris-Glycine) buffer system, and the separation performance of DIGE Gel is comparable to 12.5% Laemmli gels.

DALT gels are large enough to accommodate the longest Immobiline DryStrip gels (24 cm) and can be run in batches of up to 12 gels at a time. DALT gels can also be poured using the DALT gel caster. DALT gels can also be run using the DIGE buffer kit. Detailed protocols for gel casting can be found in the Ettan DIGE user manual, Ettan DALTwelve user manual, and Ettan DALSix user manual.

The procedures for equilibrating strips, positioning them, and electrophoresis are identical to those for standard 2-D analysis. Refer to sections 3.1 and 3.3 for details.



If the gels are to be scanned immediately, store the gels in SDS electrophoresis running buffer at room temperature in a light-tight container. Scan the gels as soon as possible as the protein spots in the gel will diffuse with time. If the gels cannot be scanned on the day of running, they should be stored in the dark at +4 °C and kept moist. Remember to let the gels warm to room temperature before scanning because temperature affects the fluorescent signal.



Do not fix the gels prior to scanning as this will affect quantitation of the labeled protein spots.

6.3.5 Summary of key differences between minimal labeling and saturation labeling

Table 43 lists the key differences between minimal labeling and saturation labeling.

Table 43. Comparison of minimal labeling and saturation labeling experiments.

	Saturation labeling	Minimal labeling
Sample preparation	Cell lysis buffer is at pH 8.0.	Cell lysis buffer is at pH 8.5.
Dyes	Maleimide dyes. Label cysteine residues. Two dyes available. CyDye DIGE Fluor saturation dyes are reconstituted at 2 mM (analytical gels) or 20 mM (preparative gels). Once reconstituted, the dyes are stable for up to 2 months at -15 °C to -30 °C. Once reconstituted, dyes do not need to be diluted further.	NHS ester dyes. Label lysine residues. Three dyes available. Once reconstituted, the concentrated stock (1 mM) of CyDye DIGE Fluor minimal dyes is stable for up to 2 months at -15 °C to -30 °C. The working concentration of the dyes is 0.4 mM and is stable for 1 week.
Reducing step	Proteins must be reduced using TCEP prior to labeling.	No reduction step required.
Protein labeling	Labeling reaction performed at 37 °C. Labeling reaction quenched using 2x sample buffer. Labeling is optimized by titrating TCEP and dye (Cy3 and Cy5) then analyzing on a 1-D gel. Labeled proteins are stable for 1 month at -70 °C.	Labeling reaction performed at 4 °C. Labeling reaction quenched with 10 mM lysine. Labeling is optimized by comparing labeled samples on a 1-D gel. Labeled proteins have stability equivalent to unlabeled protein at -70 °C.
Protein separation and analysis	No iodoacetamide equilibration step prior to 2-D electrophoresis. A Cy3 labeled sample is used to prepare a preparative gel for spot picking. No staining is required.	Iodoacetamide equilibration step required. An unlabeled sample is used to prepare a preparative gel for spot picking. The gel must be stained using a fluorescent post-stain to allow matching to analytical gels for picking.

6.3.6 Imaging

Typhoon is a highly sensitive variable-mode imager that has been adapted to meet the specific needs of 2-D DIGE. Typhoon Variable Mode Imager optimally detects Cy2, Cy3, and Cy5 signals with exceptional signal to noise ratio due to consistent point-light illumination that eliminates the need for image stitching, confocal optics that exclude artifacts, and narrow band-pass filters that maximize signal to noise ratio (Fig 60).

A linear protein concentration response over five orders of magnitude is possible with Ettan DIGE system (96) compared with silver, which has a dynamic range of less than two orders of magnitude (97). In addition, silver-stained proteins saturate more readily, which produces data that cannot be accurately quantitated. The wide dynamic range provided by CyDye 2-D DIGE Fluor minimal dyes, in combination with the Typhoon Variable Mode Imager, enables production of data that is quantitative and reproducible, and that offers a sensitivity down to 125 pg protein, compared with approximately 5 ng for silver staining (98).

Specific gel-alignment guides enable the correct positioning of both DALT and SE 600 Ruby gels on the scanner to simplify gel handling and to reduce hands-on time. Two large-format DALT gels or four SE 600 Ruby gels can be imaged simultaneously, and the file outputs are separated automatically in a format that is compatible with DeCyder 2-D Differential Analysis Software. The gels can be easily scanned between low-fluorescence glass plates, which prevents drying and shrinkage, and also allows for further running and scanning.

For additional information relating to the use of the Typhoon Variable Mode Imager for the Ettan DIGE system, refer to the Ettan DIGE user manual.

6.3.7 Image analysis with DeCyder 2-D Differential Analysis Software

DeCyder 2-D Differential Analysis Software, developed to exploit the advantages of CyDye DIGE Fluor dyes, consists of a fully automated image analysis software suite that enables the detection, quantitation, matching, and analysis of gels used with Ettan DIGE system.

The co-detection algorithm in DeCyder 2-D software co-detects overlaid image pairs and produces identical spot boundaries for each pair. This enables direct spot volume ratio measurements and therefore produces an accurate comparison of every protein with its representative in-gel internal standard. The software automatically performs detection, background subtraction, quantitation, and normalization, which takes into account any differences in the dyes, i.e. molar extinction co-efficients, quantum yields, etc.

These steps can be broken into the following processes, which form part of the built-in functionality of DeCyder 2-D software, and are performed automatically with minimum user intervention:

- Spot detection
- Background subtraction
- In-gel normalization
- Gel artifact removal
- Gel-to-gel matching
- Statistical analysis

DeCyder 2-D software utilizes the inclusion of an internal standard within each gel by performing gel-to-gel matching on the standard samples only. The presence of the same standard sample on every gel enables accurate normalization of the individual samples, decreasing gel-to-gel and software analysis variation. Differences in expression of less than 10%, with over 95% confidence, can be achieved within minutes. In conjunction with CyDye DIGE Fluor dyes, DeCyder 2-D software allows gel analysis using different experimental designs with various degrees of complexity. A simple control-treated experiment, through to a multi-factorial experiment addressing factors such as dose and time, can be performed in a single analysis.

The DeCyder 2-D software suite consists of several modules:

- Batch Processor
For automated detection, quantitation matching, and comparison of multiple gels used with Ettan DIGE system.
- Differential in-gel analysis (DIA)
For co-detection, background subtraction, normalization, and quantitation of spots in an image pair.
- Biological variation analysis (BVA)
For matching multiple gels for comparison and statistical analysis of protein-abundance changes.
- XML Toolbox
For exporting spot data from DIA or BVA modules for further analysis.
For further information relating to DeCyder 2-D Differential Analysis Software, please refer to the Ettan DIGE user manual.
- Extended Data Analysis (EDA)
Multivariate analysis of data from several BVA workspaces.

6.3.8 Further analysis of protein spots

Ettan DIGE system is fully compatible with mass spectrometry analysis and has been fully integrated into the Ettan proteomics platform. DeCyder 2-D software will generate a pick-list of spots of interest that can be exported directly into Ettan Spot Picker or Ettan Spot Handling Workstation.

Protein spots are automatically picked from the glass-backed gel. For backing of gels to glass, see appendix V.

Although spots can be picked directly from post-stained analytical gels, where possible, preparative-scale gels provide more material for analysis by mass spectrometry. A preparative gel, post-stained, can be matched to previous analytical gels by DeCyder 2-D Differential Analysis Software.

See also section 5.4.

6.4 Troubleshooting 2-D DIGE

For troubleshooting 2-D DIGE results, please refer to the Ettan DIGE user manual.

7. Troubleshooting



Table 44 lists problems that may be encountered in 2-D electrophoresis results, describes the possible causes, and suggests ways to prevent problems in future experiments.

For troubleshooting problems encountered during the various steps of the 2-D process, refer to the following:

- Table 20, page 70. Troubleshooting first-dimension IEF: Ettan IPGphor 3 Isoelectric Focusing System.
- Table 21, page 71. Troubleshooting first-dimension IEF: Employing the Manifold.
- Table 34, page 90. Troubleshooting vertical second-dimension SDS-PAGE.
- Table 36, page 95. Troubleshooting Immobiline DryStrip gel rehydration in Reswelling Tray.
- Table 38, page 103. Troubleshooting first-dimension IEF: Multiphor II Electrophoresis System and Immobiline DryStrip Kit.
- Table 40, page 107. Troubleshooting second-dimension SDS: Multiphor II Electrophoresis System.





For troubleshooting 2-D DIGE results, please refer to the Ettan DIGE user manual.

Table 44. Troubleshooting 2-D results.

Symptom	Possible cause	Remedy
No distinct spots are visible	Sample is insufficient. Insufficient sample entered the Immobiline DryStrip gel due to poor sample solubilization.	Increase the amount of sample applied. Increase the concentration of the solubilizing components in the sample solution (see section 1.6).
	Sample contains impurities that prevent focusing.	Increase the focusing time or modify the sample preparation method (see chapter 1).
	The pH gradient is incorrectly oriented.	The “+” end of the Immobiline DryStrip is the acidic end and should point toward the anode (+).
	(Flatbed gel format) Immobiline DryStrip gel is placed wrong side down on second-dimension gel.	Ensure that the Immobiline DryStrip gel is placed gel-side down (plastic backing upward) on the SDS second-dimension gel.
	Detection method was not sensitive enough.	Use another detection method (e.g. silver staining instead of Coomassie blue staining).
	Failure of detection reagents. Prepare fresh staining solutions.	Check expiry dates on staining solutions.
Individual proteins appear as multiple spots or are missing, unclear, or in the wrong position	Protein carbamylation.	Do not heat any solutions containing urea above 30 °C, as cyanate, a urea degradation product, will carbamylate proteins, changing their pI.
	Protein oxidation.	Use DeStreak Rehydration Solution. During equilibration, add DTT in first step to reduce the disulfide. Add iodoacetamide in the second step to alkylate the thiol groups to prevent proteins from reoxidizing.

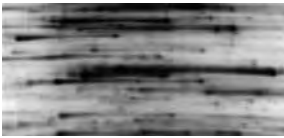
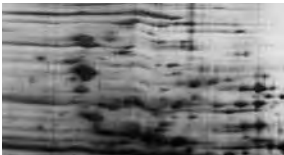

continues on following page

Table 44. Troubleshooting 2-D results (continued).

Symptom	Possible cause	Remedy
Distortion of 2-D pattern 	(Vertical gel format) The top surface of the second-dimension gel is not flat.	Immediately after pouring the gel, overlay the surface with water-saturated 1-butanol.
	(Vertical gel format) Uneven polymerization of gel due to incomplete polymerization, too rapid polymerization, or leakage during gel casting.	Degas the gel solution. Polymerization can be accelerated by increasing by 50% the amount of ammonium persulfate and TEMED used. Polymerization can be slowed by decreasing by 33% the amount of ammonium persulfate and TEMED used.
		Ensure that there is no leakage during gel casting.
Horizontal streaking or incompletely focused spots (anodic sample application, in which the problem is visible at the anodic end of the IPG strip) 	Sample applied at too acidic pH.	Increase the concentration of IPG buffer in sample and Immobiline DryStrip. Add slightly more alkaline IPG buffer to the sample. Apply the sample at the cathode. Note: Repeated precipitation resolubilization cycles produce or increase horizontal streaking. See section 1.6 for general guidelines for sample solubilization.
Horizontal streaking or incompletely focused spots (rehydration loading) 	Sample is poorly soluble in rehydration solution.	Increase the concentration of the solubilizing components in the rehydration solution (see section 2.6). Increase concentration of IPG Buffer.
	Underfocusing. Focusing time was not long enough to achieve steady-state focusing.	Prolong focusing time.
Horizontal streaking or incompletely focused spots (all sample application methods) 	Interfering substances. Non-protein impurities in the sample can interfere with IEF, causing horizontal streaking.	Modify sample preparation to limit these contaminants (see section 1.4). Use 2-D Clean-Up Kit (section 1.4.1). The effect of ionic impurities can be reduced by modifying the IEF protocol. Limit the voltage to 100-150 V for 2 h, then resume a normal voltage step program. This allows the ions in the sample to move to the ends of the Immobiline DryStrip gel.

continues on following page

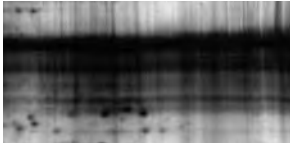
Table 44. Troubleshooting 2-D results (continued).

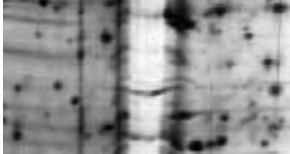
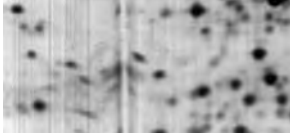
Symptom	Possible cause	Remedy
	Ionic detergent in sample.	If the ionic detergent SDS is used in sample preparation, the final concentration must not exceed 0.25% after dilution into the rehydration solution. Additionally, the concentration of the nonionic detergent present must be at least eight times higher than the concentration of any ionic detergent to ensure complete removal of SDS from the protein.
Horizontal stripes across gel 	Impurities in agarose overlay or equilibration solution.	Prepare fresh agarose overlay and equilibration solution
Prominent vertical streak at the point of sample application (when loading Immobiline DryStrip gels and sample cups) 	(Flatbed gel format) Sample aggregation or precipitation.	Dilute the sample and apply as a larger volume. Program a low initial voltage and increase voltage gradually.
Vertical gap in 2-D pattern 	Impurities in sample.	Modify sample preparation. (See section 1.4).
	Impurities in rehydration solution components.	Use only high-quality reagents. Deionize urea solutions.
	Bubble between Immobiline DryStrip gel and top surface of second-dimension gel.	Ensure that no bubbles are trapped between the Immobiline DryStrip gel and the top surface of the second-dimension gel.
	(Flatbed gel format) Urea crystals on the surface of the Immobiline DryStrip gel.	Allow residual equilibration solution to drain from the Immobiline DryStrip gel before placing the strip on the second-dimension gel.
	(Flatbed gel format) Bubbles under the Immobiline DryStrip gel.	Ensure that the Immobiline DryStrip gel is placed firmly on the gel with no air bubbles trapped underneath. Stroke the plastic backing of the Immobiline DryStrip gel gently with a pair of forceps to remove trapped bubbles.

continues on following page

Table 44. Troubleshooting 2-D results (continued).

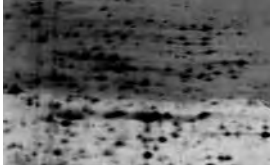
Symptom	Possible cause	Remedy
Poor representation of higher-molecular-weight proteins	Proteolysis of sample.	Prepare sample in a manner that limits proteolysis and/or use protease inhibitors (see section 1.2).
	Insufficient equilibration.	Prolong equilibration time.
	Poor transfer of protein from Immobiline DryStrip gel to second-dimension gel.	Employ a low current sample entry phase in the second-dimension electrophoresis run.
	Poor entry of sample protein during rehydration.	Use recommended volume of rehydration solution (Table 18).
Point streaking	(Silver staining) Dirty plates used to cast gel or particulate material on the surface of the gel. DTT and other thiol-reducing agents exacerbate this effect.	Properly wash glass plates. Scavenge any excess or residual thiol-reducing agent with iodoacetamide before loading the Immobiline DryStrip gel onto the second-dimension gel.
		
Background smear toward bottom of gel	(Silver or Coomassie blue staining) Staining of carrier ampholytes.	Use IPG Buffer as carrier ampholyte mixture. Reduce concentration if necessary. Prolong fixing time.
Background smear toward top of gel	(Silver staining) Nucleic acids in sample.	Add DNase and RNase to hydrolyze nucleic acids. Note: The proteins DNase and RNase may appear on the 2-D map.
High background in top region of gel	Protein contaminant in SDS electrophoresis buffer or dirty electrophoresis unit.	Make fresh SDS electrophoresis buffer. Clean electrophoresis unit.
		

Appendix I

Solutions



Some of the chemicals used in the procedures—acrylamide, N,N'-methylenebisacrylamide, ammonium persulfate, TEMED, DTT, iodoacetamide, and DeStreak Reagent—are very hazardous. Acrylamide monomer, for example, is a neurotoxin and suspected carcinogen. Read the manufacturer's safety data sheet (MSDS) detailing the properties and precautions for all chemicals in your laboratory. These safety data sheets should be reviewed prior to starting the procedures described in this handbook. General handling procedures for hazardous chemicals include using double latex gloves for all protocols. Hazardous materials should be weighed in a fume hood while wearing a disposable dust mask. Follow all local rules and regulations for handling and disposal of materials.

A. Sample preparation solution (with urea) for 2-D electrophoresis

[8 M urea, 4% CHAPS, 2% Pharmalyte or IPG buffer (carrier ampholytes), 40 mM DTT, 25 ml]

	Final concentration	Amount
Urea (FW 60.06)	8 M*	12 g
CHAPS†	4% (w/v)	1.0 g
Pharmalyte‡ or IPG Buffer§	2% (v/v)	500 µl
DTT (FW 154.2)	40 mM	154 mg
Double-distilled water	—	to 25 ml (16 ml required)

* If necessary, the concentration of urea can be increased to 9 or 9.8 M.

† Other neutral or zwitterionic detergents may be used at concentrations up to 2% (w/v). Examples include Triton X-100, NP-40, octyl glucoside, and the alkylamidiosulfobetaine detergents ASB-14 and ASB-16 (Calbiochem).

‡ Carrier ampholytes (Pharmalyte or IPG buffer) and DTT should be excluded from the sample extraction solution if the samples are to be labeled using 2-D DIGE. See Ettan DIGE User Manual for details.

§ Use IPG Buffer in the pH range corresponding to the pH range of the IEF separation to be performed, or Pharmalyte in a pH range approximating the pH range of the IEF separation to be performed.

Store in 2.5-ml aliquots at -20 °C.

Note: Protease inhibitors may be added if necessary.

B. Sample preparation solution (with urea and thiourea) for 2-D electrophoresis

[7 M urea, 2 M thiourea, 4% CHAPS, 2% Pharmalyte or IPG Buffer (carrier ampholytes), 40 mM DTT, 25 ml]

	Final concentration	Amount
Urea (FW 60.06)	7 M	10.5 g
Thiourea (FW 76.12)	2 M	3.8 g
CHAPS*	4% (w/v)	1.0 g
Pharmalyte† or IPG Buffer‡	2% (v/v)	500 µl
DTT (FW 154.2)	40 mM	154 mg
Double-distilled water	—	to 25 ml (13.5 ml required)

* Other neutral or zwitterionic detergents may be used at concentrations up to 2% (w/v). Examples include Triton X-100, NP-40, octyl glucoside, and the alkylamidiosulfobetaine detergents ASB-14 and ASB-16 (Calbiochem).

† Carrier ampholytes (Pharmalyte or IPG buffer) should be excluded from the sample extraction solution if the samples are to be labeled using 2-D DIGE.

‡ Use IPG Buffer in the pH range corresponding to the pH range of the IEF separation to be performed, or Pharmalyte in a pH range approximating the pH range of the IEF separation to be performed.

Store in 2.5-ml aliquots at -20 °C.

C. Urea rehydration stock solution

(8 M urea, 2% CHAPS, 0.5/2% Pharmalyte or IPG Buffer, 0.002% bromophenol blue, 25 ml)*

	Final concentration	Amount
Urea (FW 60.06)	8 M [†]	12 g
CHAPS [‡]	2% (w/v)	0.5 g
Pharmalyte or IPG Buffer [§] (same range as the IPG strip)	0.5% (v/v) or 2% (v/v) [†]	125 µl or 500 µl
1% Bromophenol blue stock solution	0.002%	50 µl
Double-distilled water	—	to 25 ml (16 ml required)

* DTT is added just prior to use: 7 mg DTT per 2.5-ml aliquot of rehydration stock solution. For rehydration loading, sample is also added to the aliquot of rehydration solution just prior to use.

[†] If necessary, the concentration of urea can be increased to 9 M or 9.8 M.

[‡] Other neutral or zwitterionic detergents may be used at concentrations up to 2% (w/v). Examples include Triton X-100, NP-40, octyl glucoside, and the alkylamidiosulfobetaine detergents ASB-14 and ASB-16 (Calbiochem).

[§] As an alternative to IPG Buffer, use Pharmalyte 3–10 for Immobiline DryStrip 3–10 or 3–10 NL, Pharmalyte 5–8 for Immobiline DryStrip 4–7.

[†] A Pharmalyte/IPG Buffer concentration of 0.5% (125 µl) is recommended with Ettan IPGphor 3 Isoelectric Focusing System and an IPG Buffer/Pharmalyte concentration of 2% (500 µl) is recommended with the Multiphor II and Immobiline DryStrip Kit system.

Store in 2.5-ml aliquots at -20 °C.

D. Thiourea rehydration stock solution

(7 M urea, 2 M thiourea, 2% CHAPS, 0.5/2% Pharmalyte or IPG Buffer, 0.002% bromophenol blue, 25 ml)

	Final concentration	Amount
Urea (FW 60.06)	7 M	10.5 g
Thiourea (FW 76.12)	2 M	3.8 g
CHAPS [†]	2% (w/v)	0.5 g
Pharmalyte or IPG Buffer	0.5% (v/v) or 2% (v/v) [‡]	125 µl or 500 µl
1% Bromophenol blue stock solution	0.002%	50 µl
Double-distilled water	—	to 25 ml (13.5 ml required)

* DTT is added just prior to use: Add 7 mg DTT per 2.5-ml aliquot of rehydration stock solution.

[†] Other neutral or zwitterionic detergents may be used at concentrations up to 2% (w/v). Examples include Triton X-100, NP-40, octyl glucoside, and the alkylamidiosulfobetaine detergents ASB-14 and ASB-16 (Calbiochem).

[‡] A Pharmalyte/IPG Buffer concentration of 0.5% (125 µl) is recommended with Ettan IPGphor 3 Isoelectric Focusing System and an IPG Buffer/Pharmalyte concentration of 2% (500 µl) is recommended with the Multiphor II and Immobiline DryStrip Kit system.

Store in 2.5-ml aliquots at -20 °C.

E. SDS equilibration buffer solution

(6 M urea, 75 mM Tris-HCl pH 8.8, 29.3% glycerol, 2% SDS, 0.002% bromophenol blue, 200 ml)*

	Final concentration	Amount
Urea (FW 60.06)	6 M	72.1 g
Tris-HCl, pH 8.8 (see solution H)	75 mM	10.0 ml
Glycerol (87% w/w)	29.3% (v/v)	69 ml (84.2 g)
SDS (FW 288.38)	2% (w/v)	4.0 g
1% Bromophenol blue stock solution	0.002% (w/v)	400 µl
Double-distilled water	—	to 200 ml

* This is a stock solution. Just prior to use, add DTT or iodoacetamide (for first or second equilibration, respectively) as described in the protocol in section 3.1.2.

Store in 20- or 50-ml aliquots at -20 °C.

F. 10× Laemmli SDS electrophoresis buffer

(250 mM Tris base, 1.92 M glycine, 1% SDS, 10 l)*

	Final concentration	Amount
Tris base (FW 121.1)	250 mM	303 g
Glycine (FW 75.07)	1.92 M	1441 g
SDS (FW 288.38)	1% (w/v)	100 g
Double-distilled water	—	to 10 l

* The pH of this solution should not be adjusted.

Store at room temperature.

See also Recipe M for 1× Laemmli SDS electrophoresis buffer.

G. 30% T, 2.6% C monomer stock solution

(30% acrylamide, 0.8% N,N'-methylenebisacrylamide, 1 l)

	Final concentration	Amount
Acrylamide (FW 71.08)	30%	300 g
N,N'-methylenebisacrylamide (FW 154.17)	0.8%	8 g
Double-distilled water	—	to 1 l

Filter solution through a 0.45- μ m filter. Store at 4 °C in the dark.

H. 4× resolving gel buffer solution

(1.5 M Tris base, pH 8.8, 1 l)

	Final concentration	Amount
Tris base (FW 121.1)	1.5 M	181.7 g
Double-distilled water	—	750 ml
HCl _{aq}	—	adjust to pH 8.8
Double-distilled water	—	to 1 l

Filter solution through a 0.45- μ m filter. Store at 4 °C.

I. Bromophenol blue stock solution

	Final concentration	Amount
Bromophenol blue	1%	100 mg
Tris-base	50 mM	60 mg
Double-distilled water	—	to 10 ml

J. 10% SDS solution

(10% SDS, 50 ml)

	Final concentration	Amount
SDS (FW 288.38)	10% (w/v)	5.0 g
Double-distilled water	—	to 50 ml

Filter solution through a 0.45- μ m filter. Store at room temperature.

K. 10% ammonium persulfate solution

(10% ammonium persulfate, 10 ml and 1 ml)

	Final concentration	Amount for 10 ml	Amount for 1 ml
Ammonium persulfate (FW 228.20)	10% (w/v)	1.0 g	0.1 g
Double-distilled water	—	to 10 ml	to 1 ml

Fresh ammonium persulfate “crackles” when water is added. If it does not, replace it with fresh stock. Prepare just prior to use.

L. Gel storage solution

(375 mM Tris-HCl, 0.1% SDS, 1 l)

	Final concentration	Amount
4× Resolving gel buffer (see solution H above)	1×	250 ml
10% SDS (see solution J above)	0.1%	10 ml
Double-distilled water	—	to 1 l

Store at 4 °C.

M. 1× Laemmli SDS electrophoresis buffer

(25 mM Tris base, 192 mM glycine, 0.1% SDS, 10 l)*

	Final concentration	Amount
Tris base (FW 121.1)	25 mM	30.3 g
Glycine (FW 75.07)	192 mM	144.0 g
SDS (FW 288.38)	0.1% (w/v)	10.0 g
Double-distilled water	—	to 10 l

* The pH of this solution should not be adjusted.

This solution can be prepared by diluting one volume of 10× Laemmli SDS buffer (solution F) with nine volumes of double-distilled water.

Store at room temperature.

N. Agarose sealing solution

(25 mM Tris base, 192 mM glycine, 0.1% SDS, 0.5% agarose, 0.002% bromophenol blue, 100 ml)

	Final concentration	Amount
Laemmli SDS electrophoresis buffer (see solution M)		100 ml
Agarose (NA or M)	0.5%	0.5 g
1% Bromophenol blue stock solution	0.002% (w/v)	200 µl

Add all ingredients into a 500-ml Erlenmeyer flask. Swirl to disperse. Heat in a microwave oven on low or on a heating stirrer until the agarose is completely dissolved. Do not allow the solution to boil over. Dispense 1.5-ml aliquots into screw-cap tubes and store at room temperature.

Appendix II

Optimized silver staining of large-format DALT gels and DALT 12.5 precast gels using PlusOne Silver Staining Kit, Protein

Prepare staining reagents (250 ml per gel) according to the PlusOne Silver Staining Kit, Protein instructions with the following exceptions:

1. Prepare twice the volume of fixing solution as indicated in the kit instructions (i.e. 500 ml per gel rather than 250 ml).
2. Prepare the developing solution with twice the volume of formaldehyde solution as indicated in the kit instructions (i.e. 100 μ l per 250 ml rather than 50 μ l per 250 ml).
3. Stain the gels according to the following protocol:

Step	Solutions	Amount	Time
Fixation	Ethanol	200 ml	2 × 60* min
	Acetic acid, glacial	50 ml	
	Make up to 500 ml with distilled water		
Sensitizing	Ethanol	75 ml	60 min
	Glutaraldehyde [†] (25% w/v)	1.25 ml	
	Sodium thiosulfate (5% w/v)	10 ml	
	Sodium acetate (17 g)	1 packet	
	Make up to 250 ml with distilled water		
Washing	Distilled water		5 × 8 min
Silver reaction	Silver nitrate solution (2.5% w/v)	25 ml	60 min
	Formaldehyde [†] (37% w/v)	0.1 ml	
	Make up to 250 ml with distilled water		
Washing	Distilled water		4 × 1 min
Developing	Sodium carbonate (6.25 g)	1 packet	5 min [‡]
	Formaldehyde (37%)	100 μ l [‡]	
	Make up to 250 ml with distilled water		
	Stir vigorously to dissolve sodium carbonate		
Stop	Na ₂ EDTA-H ₂ O (3.65 g)	1 packet	45 min
	Make up to 250 ml with distilled water		
Washing	Distilled water		2 × 30 min
Preservation [†]	Glycerol (supplied at 87%, final conc. 4%)	11.5 ml**	20 min
	Made up to 250 ml with distilled water		
	OR		
	Ethanol (10% v/v) ^{††}	25 ml	
	Made up to 250 ml with distilled water		

* The first fixation may be prolonged up to 3 days if desired.

[†] By omitting glutaraldehyde from the sensitizer and formaldehyde from the silver nitrate solution, as well as omitting the “preservative step”, the method becomes compatible with mass spectrometry analysis, although sensitivity is reduced. If glutaraldehyde and formaldehyde are to be used, add them just before staining.

[‡] The volume of the formaldehyde in the developing solution can be varied from 100 μ l up to 250 μ l, depending on the amount of protein and the number of spots since formaldehyde is consumed in the developing reaction by proteins. Add the formaldehyde directly before use.

[‡] Approximate time; this step may be visually monitored. The gels should be transferred to stop solution when the spots have reached the desired intensity and before the staining background becomes too dark.

** For gels cast on plastic supports, increase the amount of glycerol to 25 ml.

^{††} Short- and long-term storage of gels is possible in 10% ethanol rather than glycerol, if gels are not being dried down. Glycerol is necessary only if planning to dry down gels. Storage in ethanol allows the gels to be compatible with spot picking/mass spectrometry.

Appendix III

Colloidal Coomassie staining procedure

This method has been modified from Neuhoff *et al.* (83).

5% Coomassie Blue G-250 stock

(5% Coomassie Blue G-250, 10 ml)

	Amount
Coomassie Blue G-250	0.5 g
Double-distilled water	to 10 ml

Stir for a few minutes to disperse the Coomassie Blue G-250. The dye will not dissolve completely.

Colloidal Coomassie Blue G-250 dye stock solution

(10% ammonium sulfate, 1% (w/w) phosphoric acid, 0.1% Coomassie Blue G-250, 500 ml)

	Amount
Ammonium sulfate (FW 132.1)	50 g
Phosphoric acid 85% (w/w)	6 ml
5% Coomassie Blue G-250 stock	10 ml
Double-distilled water	to 500 ml

Colloidal Coomassie Blue G-250 working solution

(8% ammonium sulfate, 0.8% phosphoric acid, 0.08% Coomassie Blue G-250, 20% methanol, 500 ml)

	Amount
Colloidal Coomassie Blue G-250 dye stock solution	400 ml
Methanol	100 ml

Prepare colloidal stain immediately before staining the gel.

1. Fix gel for at least 30 min in 10% acetic acid, 40% ethanol.
2. Decant the fixer and place the gel in colloidal stain (100–300 ml per gel, depending on size).
3. Leave overnight or longer. The staining gets more and more intense for up to 7 days.
3. Rinse gel repeatedly with water to remove residual stain.
4. Soak in 5% glycerol, 20% ethanol for no more than 30 min prior to drying.



The above step is necessary only if drying down the gel.



Ethanol will tend to shrink the gel and make it easier to handle, but it will also destain the gel.

Appendix IV

Protocol for use of Deep Purple Total Protein Stain

Reagents supplied in the kit

Deep Purple Total Protein Stain in 50% (v/v) DMSO and 50% (v/v) acetonitrile

Required but not provided

SDS (e.g. PlusOne code number 17-1313-01)

Acrylamide gel and other related electrophoresis reagents

Citric acid

Boric acid

Sodium hydroxide

High purity water (double distilled, RO or equivalent)

Ethanol

Ammonium carbonate

Acetonitrile



High-purity water (RO quality or better) should be used as a diluent for Deep Purple Total Protein Stain and for preparing all gel processing solutions.



All reagents used should be of the highest quality available since any impurities can affect the background obtained on imaging. PlusOne reagents from GE Healthcare are recommended.

Critical parameters

Several critical parameters are important to the success of the Deep Purple Total Protein Stain protocol. Review these parameters prior to beginning the procedure.

- Ensure that the containers used for gels are clean and do not contain any contaminants. A wide variety of non-metallic containers can be used with this stain, including polypropylene, polystyrene, or Pyrex™ glass.
- Ensure that plates to be coated with Bind-Silane are prepared to the highest standard.
- Use gloves that are not powdered. Wash new gloves prior to handling plates, containers, or gels. Any powder transferred to the gel may show up as speckles on images.
- During preparation of plates for gel casting, employ methods that minimize generation of dust particles. The use of any type of paper towel will generate particulate matter that will be visualized as “speckles.” Plates should be cleaned using lint-free cloths, such as Crew™ Wipes.
- During the protein staining step, a volume of working stain solution equivalent to at least a 10-fold excess of the gel volume should be used. During all other steps a volume equivalent to ~20-fold excess of the gel volume should be used (Table A).
- Do not dilute the stain beyond 1:200 as this will result in reduced intensity and sensitivity.
- Do not re-use the stain solution as this may result in a significant loss of sensitivity.
- During the process, gel containers should be covered to exclude light and agitated gently on a mixer platform.
- The source of SDS used to prepare and run polyacrylamide gels can affect the background obtained on imaging. Use high-quality materials. Certain commercially available premade running buffers may not be suitable, particularly when using short fixation times.

Table A. Typical stain and gel processing solution volumes for the Deep Purple Total Protein Stain protocol.

Electrophoresis system	Gel dimensions (cm)	Stain volume (ml)	Processing solution volume (ml)
Ettan DALTsix	20 × 26 × 0.1	500	1000
Ettan DALTwelve	20 × 26 × 0.1	500	1000
miniVE	10 × 10 × 0.05	50	100
SE 260	10 × 10 × 0.05	50	100
SE 600	18 × 16 × 0.1	250	500

 For optimal performance, it is critical that the pH in the gel is raised before adding the stain solution. If not, high background or negative staining may be observed. Therefore, the proper wash solution in the appropriate volumes must be used

 Do not dilute the stain beyond 1:200 for gels and 1:400 for blots as this will result in reduced intensity and sensitivity.

 Do not reuse the stain solution as this may result in a significant loss of sensitivity.

If the whole staining process takes more than 8 hours; process gel containers should be covered to exclude light and agitated gently on a mixer platform.

Solution and reagents required:

A. Fixation/Acidification solution for gels

15% (v/v) ethanol / 1% citric acid (v/v) in water (approx. pH 2.3). Add 150 ml of 99.9% ethanol and 10 g citric acid to 850 ml water (check pH). Fixing solution can be stored at room temperature for up to six months.

Note: Ethanol 15% (v/v) in water can be replaced by methanol 30% (v/v) in water. Citric acid 1% (v/v) in water can be replaced by acetic acid 7.5% (v/v) in water. The concentration of acetic acid should not exceed 10%.

B. Working stain solution for gels and blots

100 mM sodium borate, pH 10.5 in water. Dissolve 6.2 g boric acid in 800 ml water and adjust pH to 10.5 with NaOH, then make to 1 l. This solution should be made fresh at the time of use by adding 1 part Deep Purple to 200 parts borate buffer for gels or 1 part Deep Purple to 400 parts of borate buffer for blots. Boric acid/NaOH buffer may be prepared in advance and can be stored for up to 6 months.

C. Wash solution for gels

15% (v/v) ethanol in water. Add 150 ml ethanol to 850 ml water. Washing solution may be prepared in advance and can be stored at room temperature for up to 6 months.

Note: Ethanol 15% (v/v) in water can be replaced by methanol 30% (v/v) in water. We recommend that you consistently use either methanol or ethanol throughout the procedure.

D. Storage solution for gels

Gels should be stored at 4°C protected from light in 1% citric acid. Add 10 g citric acid to 1 l water (pH 2.3). For extended storage (up to 6 months), add Deep Purple (1:200) to the storage solution.

Protocol

 Low-fluorescence glass plates should be used for plastic-backed gels, as these backed gels have problems with background.

Gel electrophoresis

Perform electrophoresis according to established techniques.

Note: If visual orientation is required on 1D gels, Rainbow™ Markers (RPN800) may be used. If a tracking dye is used in the loading buffer, such as bromophenol blue, it is recommended to run the dye front just off the bottom of the gel.

Fixation

1. Place an appropriate volume of 15% ethanol /1% citric acid (v/v, solution A) into the containers that will be used to process gels. The recommended volume of fixation solution required is ~20 fold excess of the gel volume (Table A).

Note: Alternative fixation solutions that have been used successfully with Deep Purple Total Protein Stain are:

- 7.5% acetic acid/10% ethanol
- 7.0% acetic acid/30% ethanol

2. Dismantle the electrophoresis apparatus.

For free-floating gels, remove the gel from the plates by floating the gel off with gentle agitation in the fix solution.

For backed gels, place the gel and plate directly into the fix solution.

Note: Place only one gel in each container. The stacking gel can be left attached to help with gel orientation.

3. Incubate in the fixation solution A, for a minimum of 1 hour, at room temperature with gentle agitation.

Note: Overnight fixation should be used for backed gels, large format gels and thick gels (≥ 1.5 mm) and it is also recommended for applications where maximum sensitivity is required.

Staining

1. Take the stain out of the freezer (-15 to -30 °C) and allow to stand at room temperature for 15-30 min. Prepare working stain solution B.

2. Pour off the fixation solution and replace with working stain solution B in ~20-fold excess.

Try to minimize carry-over of the acidic fixation solution. Stain for 1 hour (1.0 mm thick gels). For gels 1.5 mm thick or backed gels, increase the staining time to 1.5 hours. Extending the staining time up to 2 hours will not adversely affect results. There will be some loss in fluorescence intensity if the staining time is greater than 3 hours.

Note: The staining solution degrades over time and should not be stored. If the total staining procedure is extended to more than eight hours, containers can be wrapped in foil or covered with black plastic. Alternatively, containers and lids of a solid colored plastic may be used.

3. Pour off the stain solution and wash the gels by gentle rocking in wash solution C for 30 minutes. This step should be increased to 45 min for 1.5 mm gels or if you experience high background fluorescence.
4. Remove gels from wash solution and acidify by placing them in solution A and rock gently for 30 min. This step may be repeated or extended up to overnight to reduce background staining. If this step is prolonged to over night, gels should be protected from light. Prior to imaging, gels should be rinsed 5 minutes in wash solution C. The gel can be imaged at this stage.

Note: If the gels swell during the staining process, soak the gels in solution A for 30 min prior to analysis.

After imaging, the gels can be stored at 4°C protected from light in gel 1% citric acid (solution D). For longterm storage (more than 6 months), add Deep Purple (1:200 dilution) to the storage solution. If stored, gels should be rinsed (2 x 15 min) in 15% ethanol (solution C) prior to imaging. Acidifying in 15% ethanol/1% citric acid (solution A) for 15 minutes may be used to reduce background.

Visualization

A. Flat-bed laser-based fluorescence imaging systems

1. Ensure that the scanning bed of the laser is clean and free from smears and particles. Follow recommended procedures provided with the instrument.

Note: On the Typhoon scanner it has been shown that fluorescent contamination on the platen can be eliminated by wiping the surface with 10% (v/v) H₂O₂ (hydrogen peroxide) followed by a rinse with double-distilled water (see the user manual for full details).

2. Set up the scanner as recommended in the relevant system operational manual. For example, the following settings are recommended for use with a Typhoon scanner:

Excitation: Green laser (532 nm)

Emission: 560LP or 610BP filter.

Pre-scan using 1000 micron resolution and then scan using a 100 micron resolution.

Note: If the pre-scan shows saturated bands/spots, reduce the PMT voltage rating and pre-scan again. If the pre-scan shows too low signal increase the PMT voltage rating and pre-scan again. Deep Purple Total Protein Stain can also be imaged on a Typhoon scanner using the blue laser (457 nm or 488 nm). If using an alternate fluorescent scanner, for the best optimal images, scan using as similar settings as possible to those recommended.

3. Process the image according to experimental requirements and the instructions for the relevant software program.

B. Imaging with UV light sources

1. Place the gel onto the UV transilluminator (302 or 365 nm wavelength emission required) and follow the operating and safety instructions as relevant for the excitation instrument and imaging system. Images can be captured using appropriate camera systems and filters (film, video, CCD).

Note: For long periods of illumination it is advisable to place the gel on a glass plate, raised on spacers above the transilluminator, in order to reduce heat damage to the stained proteins. Cooling the gel prior to visualization can also help reduce degradation.

2. If required, pick any bands/spots.

Note: If manually picking bands/spots, it is advisable to place gels on a glass plate in order to reduce possible damage to the instrument surface. Prolonged, continuous exposure to a strong UV light source will degrade the Deep Purple Total Protein Stain signal, with a half-life in the region of 15 to 30 min.

Refer to the Deep Purple Total Protein Stain product instructions for additional information on re-staining of gels, alternative staining trays, alternative imaging instruments, use of Deep Purple Total Protein Stain with Ettan DIGE, and cleaning of imaging instruments. For cleaning and preparation of Bind-Silane coated plates, refer to appendix V.

The instructions accompanying Deep Purple Total Protein Stain also include a troubleshooting guide.

Appendix V

Treating glass plates with Bind-Silane

Spot picking with Ettan Spot Picker or Spot Handling Workstation requires that gels are precast on backing (e.g. Ettan DALT II Precast Gel 12.5) or immobilized on backing during casting. Two different types of backing may be used: GelBond PAGfilm or a glass plate, treated with Bind-Silane solution.



To scan a gel with fluorescently labeled proteins, it is important that GelBond not be used for the gel backing. GelBond is a plastic material and fluoresces intensely at the wavelengths used for scanning.

Protocol to treat glass plates with Bind-Silane



The glass plates must be properly cleaned. Before re-use, soak the plates overnight in a 5% Decon™ 90 solution. Do not leave plates standing in a Decon solution for a longer time as this will eventually cause etching due to the alkali nature of Decon.

1. Thoroughly wash each plate to be treated. Take care to remove any gel fragments attached to the plate from previous gels. The careful cleaning of the glass plates before casting is important, to ensure a uniform coating with the Bind-Silane and to avoid keratin contamination.
2. Thoroughly rinse the plates with double-distilled water to remove Decon.
3. Dry the plates using a lint-free tissue or leave them to air dry.
4. Prepare the Bind-Silane working solution:

Ethanol	8 ml
Glacial acetic acid	200 µl
Bind-Silane	10 µl
Double-distilled water	1.8 ml
5. Pipette 2–4 ml (depending on plate size) of the Bind-Silane working solution onto each plate and distribute equally over the plate with a lint-free tissue such as Crew Wipes.
Cover the plate to prevent dust contamination and leave to air dry on the bench for 1–1.5 h.
6. Polish the plate with a lint-free tissue such as Crew Wipes, moistened with a small amount of double-distilled water or ethanol.

The gels will stay attached to the glass during electrophoresis, staining procedures, scanning, and storage.

Appendix VI

Using Ready-Sol

PlusOne ReadySol IEF, 40%T and 3%C (see ordering information) is a premade stock solution of acrylamide and bisacrylamide. Note that the %C will not change on dilution as it is a ratio. The table below provides the recipe for making 100 ml of each percentage gel.

	5%	7.5%	10%	12.5%	15%
Monomer stock solution (ReadySol 40%T, 3% C) (ml)	12.5	18.75	25.0	31.25	37.5
4× Resolving gel buffer (ml)*	25.0	25.0	25.0	25.0	25.0
10% SDS (ml)	1.0	1.0	1.0	1.0	1.0
Double-distilled water (ml)	61.0	54.75	48.5	42.25	36.0
10% Ammonium persulfate† (ml)	0.5	0.5	0.5	0.5	0.5
TEMED†	33 µl	33 µl	33 µl	33 µl	33 µl

* 4× Resolving gel buffer is 1.5 M Tris base, pH 8.8. To make, mix 181.7 g Tris base with 750 ml double-distilled water, adjust the pH to 8.8 with HCl, and make up to final volume of 1 l with double-distilled water. See also solution H in appendix I.

† Add ammonium persulfate and TEMED just before casting the gel.

References

1. O'Farrell, P. H. High resolution two-dimensional electrophoresis of proteins. *J. Biol. Chem.* **250**, 4007–4021 (1975).
2. Bjellqvist, B. *et al.* Isoelectric focusing in immobilized pH gradients: principle, methodology and some applications. *J. Biochem. Biophys. Methods* **6**, 317–339 (1982).
3. Görg, A. *et al.* The current state of two-dimensional electrophoresis with immobilized pH gradients. *Electrophoresis* **9**, 531–546 (1988).
4. Görg, A. *et al.* The current state of two-dimensional electrophoresis with immobilized pH gradients. *Electrophoresis* **21**, 1037–1053 (2000).
5. Ünlü, M. *et al.* Difference gel electrophoresis: a single gel method for detecting changes in protein extracts. *Electrophoresis* **18**, 2071–2077 (1997).
6. Wilkins, M. R. *et al.* From proteins to proteomes: large scale protein identification by two-dimensional electrophoresis and amino acid analysis. *Biotechnology* **14**, 61–65 (1996).
7. Pennington, S. R. *et al.* Proteome analysis: from protein characterization to biological function. *Trends Cell Bio* **7**, 168–173 (1997).
8. Görg, A. *et al.* Two-dimensional polyacrylamide gel electrophoresis with immobilized pH gradients in the first dimension (IPG-Dalt): the state of the art and the controversy of vertical vs horizontal systems. *Electrophoresis* **16**, 1079–1086 (1995).
9. Lenstra, J. A. and Bloemendal, H. Topography of the total protein population from cultured cells upon fractionation by chemical extractions. *Eur. J. Biochem.* **135**, 413–423 (1983).
10. Molloy, M. P. *et al.* Extraction of membrane proteins by differential solubilization for separation using two-dimensional gel electrophoresis. *Electrophoresis* **19**, 837–844 (1998).
11. Ramsby, M. L. *et al.* Differential detergent fractionation of isolated hepatocytes: biochemical, immunochemical and two-dimensional gel electrophoresis characterization of cytoskeletal and noncytoskeletal compartments. *Electrophoresis* **15**, 265–277 (1994).
12. Taylor, R. S. *et al.* Proteomics of rat liver Golgi complex: minor proteins are identified through sequential fractionation. *Electrophoresis* **21**, 3441–3459 (2000).
13. Deutscher, M. P., ed. Guide to protein purification. *Methods Enzymol.* **182**, 1–894 (1990).
14. Dunn, M. J. and Corbett, J. M. 2-dimensional polyacrylamide gel electrophoresis. *Methods Enzymol.* **271**, 177–203 (1996).
15. Rabilloud, T. Solubilization of proteins for electrophoretic analysis. *Electrophoresis* **17**, 813–829 (1996).
16. Rabilloud, T. *et al.* Improvement of the solubilization of proteins in two-dimensional electrophoresis with immobilized pH gradients. *Electrophoresis* **18**, 307–316 (1997).
17. Bollag, D. M. *et al.* Protein extraction, in *Protein Methods*, Wiley-Liss, New York (1991).
18. Scopes, R. K. Making an Extract, in *Protein purification: Principles and practice*, 2nd Ed., Springer Verlag, New York (1987).
19. Dignam, J. D. Preparation of extracts from higher eukaryotes. *Methods Enzymol.* **182**, 194–203 (1990).
20. Toda, T. *et al.* Detection of thymopietin-responsive proteins in nude mouse spleen cells by two-dimensional polyacrylamide gel electrophoresis and image processing. *Electrophoresis* **15**, 984–987 (1994).
21. Sanchez, J.-C. *et al.* Inside SWISS-2D PAGE database. *Electrophoresis* **16**, 1131–1151 (1995).
22. Portig, I. *et al.* Identification of stress proteins in endothelial cells. *Electrophoresis* **17**, 803–808 (1996).
23. Cull, M. and McHenry, C. S. Preparation of extracts from prokaryotes. *Methods Enzymol.* **182**, 147–153 (1990).
24. Jazwinski, S. M. Preparation of extracts from yeast. *Methods Enzymol.* **182**, 154–174 (1990).
25. Kawaguchi, S.-I. and Kuramitsu, S. Separation of heat-stable proteins from *Thermus thermophilus* HB8 by two-dimensional electrophoresis. *Electrophoresis* **16**, 1060–1066 (1995).
26. Teixeira-Gomes, A. P. *et al.* Mapping and identification of *Brucella melitensis* proteins by two-dimensional electrophoresis and microsequencing. *Electrophoresis* **18**, 156–162 (1997).
27. Ames, G. F.-L. and Nikaido, K. Two-dimensional gel electrophoresis of membrane proteins. *Biochemistry* **15**, 616–623 (1976).
28. Görg, A. *et al.* Two-dimensional electrophoresis with immobilized pH gradients of leaf proteins from barley (*Hordeum vulgare*): method, reproducibility and genetic aspects. *Electrophoresis* **9**, 681–692 (1988).
29. Posch, A. *et al.* Genetic variability of carrot seed proteins analyzed by one- and two-dimensional electrophoresis with immobilized pH gradients. *Electrophoresis* **16**, 1312–1316 (1995).
30. Geigenheimer, P. Preparation of extracts from plants. *Methods Enzymol.* **182**, 174–193 (1990).

31. Theillet, C. *et al.* Influence of the excision shock on the protein metabolism of *Vicia faba* L. meristematic root cells. *Planta* **155**, 478–485 (1982).
32. Wolpert, T. J. and Dunkle, L. D. Alterations in gene expression in sorghum induced by the host-specific toxin from *Periconia circinata*. *Proc. Natl. Acad. Sci. USA* **80**, 6576–6580 (1983).
33. Blomberg, A. *et al.* Interlaboratory reproducibility of yeast protein patterns analyzed by immobilized pH gradient two-dimensional gel electrophoresis. *Electrophoresis* **16**, 1935–1945 (1995).
34. Damerval, C. *et al.* Technical improvements in two-dimensional electrophoresis increase the level of genetic variation detected in wheat-seedling proteins. *Electrophoresis* **7**, 52–54 (1986).
35. Wu, F.-S. and Wang, M.-Y. Extraction of proteins for sodium dodecyl sulfate-polyacrylamide gel electrophoresis from protease-rich plant tissues. *Anal. Biochem.* **139**, 100–103 (1984).
36. Harrison, P. A. and Black, C. C. Two-dimensional electrophoretic mapping of proteins of bundle sheath and mesophyll cells of the C4 grass *Digitaria sanguinalis*. *Plant Physiol.* **70**, 1359–1366 (1982).
37. Granzier, H. L. M. and Wang, K. Gel electrophoresis of giant proteins: solubilization and silver-staining of titin and nebulin from single muscle fiber segments. *Electrophoresis* **14**, 56–64 (1993).
38. Colas des Francs, C. *et al.* Analysis of leaf proteins by two-dimensional gel electrophoresis. *Plant Physiol.* **78**, 178–182 (1985).
39. Barret, A. J. and Salversen, G. *Proteinase Inhibitors*, Elsevier Press, Amsterdam (1986).
40. North, M. J. Prevention of unwanted proteolysis, in *Proteolytic Enzymes: A Practical Approach* (Beynon, R. J. and Bond, J. S., eds.), IRL Press, Oxford, pp 105–124 (1989).
41. Salvesen, G. and Nagase, H. Inhibition of proteolytic enzymes, in *Proteolytic Enzymes: A Practical Approach* (Beynon, R. J. and Bond, J. S., eds.), IRL Press, Oxford, pp 83–104 (1989).
42. Hurkman, W. J. and Tanaka, C. K. Solubilization of plant membrane proteins for analysis by two-dimensional gel electrophoresis. *Plant Physiol.* **81**, 802–806 (1986).
43. Granier, F. Extraction of plant proteins for two-dimensional electrophoresis. *Electrophoresis* **9**, 712–718 (1988).
44. Englard, S. and Seifter, S. Precipitation techniques. *Methods Enzymol.* **182**, 285–300 (1990).
45. Cremer, F. and Van de Walle, C. Method for extraction of proteins from green plant tissues for two-dimensional polyacrylamide gel electrophoresis. *Anal. Biochem.* **147**, 22–26 (1985).
46. Guy, G. R. *et al.* Analysis of cellular phosphoproteins by two-dimensional gel electrophoresis: applications for cell signaling in normal and cancer cells. *Electrophoresis* **15**, 417–440 (1994).
47. Meyer, Y. *et al.* Preparation by two-dimensional electrophoresis of proteins for antibody production: antibodies against proteins whose synthesis is reduced by auxin in tobacco mesophyll protoplasts. *Electrophoresis* **9**, 704–712 (1988).
48. Halloway, P. and Arundel, P. High-resolution two-dimensional electrophoresis of plant proteins. *Anal. Biochem.* **172**, 8–15 (1988).
49. Flengsrud, R. and Kobro, G. A method for two-dimensional electrophoresis of proteins from green plant tissues. *Anal. Biochem.* **177**, 33–36 (1989).
50. Matsui, N. M. *et al.* Immobilized pH gradient two-dimensional gel electrophoresis and mass spectrometric identification of cytokine-regulated proteins in ME-180 cervical carcinoma cells. *Electrophoresis* **18**, 409–417 (1997).
51. Tsugita, A. *et al.* Two-dimensional electrophoresis of plant proteins and standardization of gel patterns. *Electrophoresis* **17**, 855–865 (1996).
52. Görg, A. *et al.* Very alkaline immobilized pH gradients for two-dimensional electrophoresis of ribosomal and nuclear proteins. *Electrophoresis* **18**, 328–337 (1997).
53. Usuda, H. and Shimogawara, K. Phosphate deficiency in maize. VI. Changes in the two-dimensional electrophoretic patterns of soluble proteins from second leaf blades associated with induced senescence. *Plant Cell Physiol.* **36**, 1149–1155 (1995).
54. Stasyk, T. *et al.* Optimizing sample preparation for 2-D electrophoresis. *Life Science News* **9**, 8–11 (2001).
55. Musante, L. *et al.* Resolution of fibronectin and other uncharacterized proteins by two-dimensional polyacrylamide electrophoresis with thiourea. *J. Chromat.* **705**, 351–356 (1997).
56. Pasquali, C. *et al.* Preparative two-dimensional gel electrophoresis of membrane proteins. *Electrophoresis* **18**, 2573–2581 (1997).
57. Rabilloud, T. Use of thiourea to increase the solubility of membrane proteins in two-dimensional electrophoresis. *Electrophoresis* **19**, 758–760 (1998).
58. Perdew, G. H. *et al.* The use of a zwitterionic detergent in two-dimensional gel electrophoresis of trout liver microsomes. *Anal. Biochem.* **135**, 453–455 (1983).
59. Rabilloud, T. *et al.* Analysis of membrane proteins by two-dimensional electrophoresis: comparison of the proteins extracted from normal or *Plasmodium falciparum*-infected erythrocyte ghosts. *Electrophoresis* **20**, 3603–3610 (1999).

60. Santoni, V. *et al.* Membrane proteins and proteomics: un amour impossible? *Electrophoresis* **21**, 1054–1070 (2000).
61. Wilson, D. L. *et al.* Some improvements in two-dimensional gel electrophoresis of proteins. *Anal. Biochem.* **83**, 33–44 (1977).
62. Olsson, I. *et al.* Organic disulfides as a means to generate streak-free two-dimensional maps with narrow range basic immobilized pH gradient strips as first dimension. *Proteomics* **2**, 1630–1632 (2002).
63. Herbert, B. R. *et al.* Improved protein solubility in two-dimensional electrophoresis using tributyl phosphine as reducing agent. *Electrophoresis* **19**, 845–851 (1998).
64. Wildgruber, W. *et al.* Web-based two-dimensional database of *Saccharomyces cerevisiae* proteins using immobilized pH gradients from pH 6 to pH 12 and matrix-assisted laser desorption/ionization-time of flight mass spectrometry. *Proteomics* **2**, 727–732 (2002).
65. Bradford, M. M. A rapid and sensitive method for the quantitation of microgram quantities of protein utilizing the principle of protein-dye binding. *Anal. Biochem.* **72**, 248–254 (1976).
66. Lowry, O. H. *et al.* Protein measurement with the folin phenol reagent. *J. Biol. Chem.* **193**, 265–275 (1951).
67. Smith, P. K. *et al.* Measurement of protein using bicinchoninic acid. *Anal. Biochem.* **150**, 76–85 (1985).
68. Goshev, I. and Nedkov, P. Extending the range of application of the biuret reaction: quantitative determination of insoluble proteins. *Anal. Biochem.* **95**, 340–343 (1979).
69. Bjellqvist, B. *et al.* Micropreparative two-dimensional electrophoresis allowing the separation of samples containing milligram amounts of proteins. *Electrophoresis* **14**, 1375–1378 (1993).
70. Sanchez, J.-C. *et al.* Improved and simplified in-gel sample application using reswelling of dry immobilized pH gradients. *Electrophoresis* **18**, 324–327 (1997).
71. Rabilloud, T. *et al.* Sample application by in-gel rehydration improves the resolution of two-dimensional electrophoresis with immobilized pH gradients in the first dimension. *Electrophoresis* **15**, 1552–1558 (1994).
72. Westermeier, R. *Electrophoresis in Practice*, 3rd Ed., Wiley-VCH Verlag GmbH, Weinheim (2001).
73. Westermeier, R. and Naven, T. *Proteomics in Practice, A Laboratory Manual of Proteome Analysis*, Wiley-VCH Verlag GmbH, Weinheim (2002).
74. Sabounchi-Schütt, F. *et al.* An Immobiline DryStrip application method enabling high-capacity two-dimensional gel electrophoresis. *Electrophoresis* **21**, 3649–3656 (2000).
75. Bjellqvist, B. *et al.* A nonlinear wide-range immobilized pH gradient for two-dimensional electrophoresis and its definition in a relevant pH scale. *Electrophoresis* **14**, 1357–1365 (1993).
76. Görg, A. *et al.* 2-D electrophoresis with immobilized pH gradients using IPGphor isoelectric focusing system. *Life Science News* **1**, 4–6 (1998).
77. Ibel, K. *et al.* Protein-decorated micelle structure of sodium-dodecyl-sulfate protein complexes as determined by neutron scattering. *Eur. J. Biochem.* **190**, 311–318 (1990).
78. Laemmli, U. K. Cleavage of structural proteins during the assembly of the head of bacteriophage T4. *Nature* **227**, 680–685 (1970).
79. Schägger, H. and von Jagow, G. Tricine-sodium dodecyl sulfate-polyacrylamide gel electrophoresis for the separation of proteins in the range from 1 to 100 kDa. *Anal. Biochem.* **166**, 368–379 (1987).
80. Görg, A. *et al.* Elimination of point streaking on silver stained two-dimensional gels by addition of iodoacetamide to the equilibration buffer. *Electrophoresis* **8**, 122–124 (1987).
81. Shevchenko, A. *et al.* Mass spectrometric sequencing of proteins from silver stained polyacrylamide gels. *Anal. Chem.* **68**, 850–858 (1996).
82. Neuhoff, V. *et al.* Clear background and highly sensitive protein staining with Coomassie Blue dyes in polyacrylamide gels: a systematic analysis. *Electrophoresis* **6**, 427–448 (1985).
83. Neuhoff, V. *et al.* Improved staining of proteins in polyacrylamide gels including isoelectric focusing gels with clear background at nanogram sensitivity using Coomassie Brilliant Blue G-250 and R-250. *Electrophoresis* **9**, 255–262 (1988).
84. Yan, J. X. *et al.* A modified silver staining protocol for visualization of proteins compatible with matrix-assisted laser desorption/ionization and electrospray ionization-mass spectrometry. *Electrophoresis* **21**, 3666–3672 (2000).
85. Fernandez-Patron, C. *et al.* Understanding the mechanism of the zinc-ion stains of biomacromolecules in electrophoresis gels: generalization of the reverse-staining technique. *Electrophoresis* **19**, 2398–2406 (1998).
86. Mackintosh, J.A. *et al.* A fluorescent natural product for ultra sensitive detection of proteins in one-dimensional and two-dimensional gel electrophoresis. *Proteomics* **3**, 2273–2288 (2003).
87. Steinberg, T. H. *et al.* Applications of SYPRO Orange and SYPRO Red protein gel stains. *Anal. Biochem.* **239**, 238–245 (1996).

88. Steinberg, T. H. *et al.* Fluorescence detection of proteins in sodium dodecylsulphate-polyacrylamide gels using environmental benign, nonfixative saline solution. *Electrophoresis* **21**, 497–508 (2000).
89. Patton, W. Detecting proteins in polyacrylamide gels and on electroblot membranes, in *Proteomics: from protein sequence to function* (Pennington, S. R. and Dunn, M. J., eds.), Bios Scientific Publishers Ltd., pp 65–86 (2001).
90. Yan, J. X. *et al.* Postelectrophoretic staining of proteins separated by two-dimensional gel electrophoresis using SYPRO dyes. *Electrophoresis* **21**, 3657–3665 (2000).
91. Lopez, M. F. *et al.* A comparison of silver stain and SYPRO Ruby Protein Gel Stain with respect to protein detection in two-dimensional gels and identification by peptide mass profiling. *Electrophoresis* **21**, 3673–3683 (2000).
92. Tonge, R. *et al.* Validation and development of fluorescence two-dimensional differential gel electrophoresis proteomics technology. *Proteomics* **1**, 377–396 (2001).
93. Ruepp, S. U. *et al.* Genomics and proteomics analysis of acetaminophen toxicity in mouse liver. *Toxicol. Sci.* **65**, 135–150 (2002).
94. Zhou, G. *et al.* 2D differential in-gel electrophoresis for the identification of esophageal scans cell cancer-specific protein markers. *Mol. Cell Proteomics* **1**, 117–123 (2002).
95. Alban, A. *et al.* A novel experimental design for comparative two-dimensional gel analysis: two-dimensional difference gel electrophoresis incorporating an internal standard. *Proteomics* **3**, 36–44 (2003).
96. Yan, J. *et al.* Fluorescence 2-D difference gel electrophoresis and mass spectrometry based proteomic analysis of *Escherichia coli*. *Proteomics* **2**, 1682–1698 (2002).
97. Syrový, I. and Hodny, Z. Staining and quantification of proteins separated by polyacrylamide gel electrophoresis. *J. Chromat.* **569**, 175–196 (1991).
98. Gharbi, S. *et al.* Evaluation of two-dimensional differential gel electrophoresis for proteomic expression analysis of a model breast cancer cell system. *Mol. Cell. Proteomics* **1**, 91–98 (2002).

Additional reading and reference material

Item (literature type in parentheses)	Code No.
2-D electrophoresis: a comparison of carrier ampholyte and immobilized pH gradients (scientific poster)	80-6419-53
Automated staining of polyacrylamide gels with Hoefer Processor Plus (technical manual)	80-6343-34
Blot processing with the Processor Plus (handbook)	80-6447-27
Comparison of Deep Purple Total Protein Stain and Sypro Ruby in 1-D and 2-D gel electrophoresis (application note)	18-1177-44
CyDye DIGE Fluors and Labeling Kits (data file)	18-1164-84
DeCyder 2-D Differential Analysis Software v 7.0 (data file)	28-4015-43
DIGE Gel and DIGE Buffer Kit (data file)	28-9480-26
Detection and mass spectrometry identification of protein changes in low-abundance tissue using CyDye DIGE Fluor saturation dyes (data file)	18-1177-51
Electrophoresis in Practice Westermeier, R., Wiley-VCH Verlag GmbH, Weinheim (2001)	18-1124-59
DALTsix Large Vertical Electrophoresis System for second dimension 2-D electrophoresis (data file)	80-6490-02
Fluorescence Imaging: principles and methods (handbook)	63-0035-28
ImageMaster 2-D Platinum (data file)	18-1177-20
Immobiline DryStrip Gels (data file)	18-1177-60
Immobiline DryStrip visualization of pH gradients (technical brochure)	18-1140-60
Immobiline DryStrip (instructions)	28-9537-55
Improved detection and identification of low-abundance human bronchoalveolar lavage fluid (BALF) proteins using 2-D electrophoresis and Ettan MALDI-ToF mass spectrometry (application note)	18-1151-35
Improved spot resolution and detection of proteins in 2-D electrophoresis using 24 cm Immobiline DryStrip gels (application note)	18-1150-23
Multiple mini-format 2-D electrophoresis using Hoefer™ SE 600 Standard Vertical Electrophoresis Unit (application note)	80-6445-94
Multiple mini-format 2-D electrophoresis. Multiphor II Flatbed (application note)	80-6443-47
PlusOne sample preparation kits and reagents (brochure)	80-6487-74
Protein analysis - using the power of 2-D electrophoresis (brochure)	18-1124-82
Protein electrophoresis (technical manual)	80-6013-88
Proteomics in Practice, A Laboratory Manual of Proteome Analysis, Westermeier, R. and Naven, T., Wiley-VCH Verlag GmbH, Weinheim (2002)	18-1164-45
Typhoon Variable Mode Imager (data file)	63-0048-48
User manuals	
Ettan DIGE	18-1164-40
DeCyder 2D™ 7.0 User Manual	28-9414-47
Ettan DALTsix	80-6492-49
Ettan Ettan Gel 12.5 and Ettan DALT Buffer Kit	71-5019-56
Ettan IPGphor 3	11-0034-58
miniVE	80-6420-86
Multiphor II Electrophoresis System	18-1103-43
SE 260	80-6291-95
SE 600 Ruby	80-6353-79

Many of these items can be downloaded from the Literature section on www.gehealthcare.com

Ordering information

Product	Quantity	Code No.
Sample preparation kits and reagents		
Sample Grinding Kit	50 samples	80-6483-37
Protease Inhibitor Mix	1 ml	80-6501-23
illustra triplePrep Kit	50 preps	28-9425-44
Nuclease Mix	0.5 ml	80-6501-42
Albumin and IgG Removal Kit	10 samples	RPN6300
2-D Clean-Up Kit	50 samples	80-6484-51
2-D Quant Kit	500 assays	80-6483-56
2-D Protein Extraction Buffer Trial Kit	6 x 10 ml	28-9435-22
Mini Dialysis Kit, 1 kDa cut-off, up to 250 µl	50 samples	80-6483-75
Mini Dialysis Kit, 1 kDa cut-off, up to 2 ml	50 samples	80-6483-94
Mini Dialysis Kit, 8 kDa cut-off, up to 250 µl	50 samples	80-6484-13
Mini Dialysis Kit, 8 kDa cut-off, up to 2 ml	50 samples	80-6484-32
Vivaspin 6 MWCO 50 000	25 pack	28-9323-18
Spectrophotometer		
Ultrospec 3100 pro UV/Visible Spectrophotometer		Inquire
First-dimension products and accessories		
Ettan IPGphor 3 Isoelectric Focusing System		
Ettan IPGphor 3 Isoelectric Focusing Unit	1	11-0033-64
Ettan IPGphor Manifold, Complete		80-6498-38
IPGbox kit	1	28-9334-92
Sample cups	120/pk	80-6498-95
Paper electrode	240/pk	80-6499-14
Paper bridge pads	120/pk	80-6499-33
Multiphor II Electrophoresis System and accessories		
Multiphor II Electrophoresis Unit		18-1018-06
MultiTemp III Thermostatic Circulator, 115 V		18-1102-77
MultiTemp III Thermostatic Circulator, 230 V		18-1102-78
EPS 3501 XL Power Supply		18-1130-05
Immobiline DryStrip Kit and other accessories		
Immobiline DryStrip Kit (for use with Multiphor II only)		18-1004-30
Immobiline DryStrip Cover Fluid	1 l	17-1335-01
Sample cups	60/pk	18-1004-35
IEF electrode strips	100/pk	18-1004-40
See also under Second-dimension products and accessories		
Strip Holders for use with Immobiline DryStrip and Ettan IPGphor 3 Isoelectric Focusing System		
7 cm	1/pk	80-6416-87
	6/pk	80-6416-11
11 cm	1/pk	80-6417-06
	6/pk	80-6416-30
13 cm	1/pk	80-6417-25
	6/pk	80-6416-49
18 cm	1/pk	80-6417-44
	6/pk	80-6416-68
24 cm	1/pk	80-6470-07
	6/pk	80-6469-88
Immobiline DryStrip Cover Fluid	1 l	17-1335-01
Cleaning Solution, Strip Holder	950 ml	80-6452-78

Product	Quantity	Code No.
Immobiline DryStrip gels (all 12/pk)		
7 cm	pH 3-5.6 NL	17-6003-53
	pH 3-10	17-6001-11
	pH 3-10 NL	17-6001-12
	pH 3-11 NL	17-6003-73
	pH 5.3-6.5	17-6003-58
	pH 6.2-7.5	17-6003-63
	pH 4-7	17-6001-10
	pH 6-11	17-6001-94
	pH 7-11 NL	17-6003-68
11 cm	pH 3-5.6 NL	17-6003-54
	pH 3-10	18-1016-61
	pH 3-11 NL	17-6003-74
	pH 4-7	18-1016-60
	pH 5.3-6.5	17-6003-59
	pH 6-11	17-6001-95
	pH 6.2-7.5	17-6003-64
pH 7-11 NL	17-6003-69	
13 cm	pH 3-5.6 NL	17-6003-55
	pH 3-10	17-6001-14
	pH 3-10 NL	17-6001-15
	pH 3-11 NL	17-6003-75
	pH 4-7	17-6001-13
	pH 5.3-6.5	17-6003-60
	pH 6-11	17-6001-96
	pH 6.2-7.5	17-6003-65
pH 7-11 NL	17-6003-70	
18 cm	pH 3-5.6 NL	17-6003-56
	pH 3-10	17-1234-01
	pH 3-10 NL	17-1235-01
	pH 3-11 NL	17-6003-76
	pH 4-7	17-1233-01
	pH 6-11	17-6001-97
	pH 6-9	17-6001-88
	pH 6.2-7.5	17-6003-66
	pH 7-11 NL	17-6003-71
24 cm	pH 3-5.6 NL	17-6003-57
	pH 3-10	17-6002-44
	pH 3-10 NL	17-6002-45
	pH 3-11 NL	17-6003-77
	pH 3.5-4.5	17-6002-38
	pH 4-7	17-6002-46
	pH 6-9	17-6002-47
	pH 3-7 NL	17-6002-43
	pH 6.2-7.5	17-6003-67
pH 7-11 NL	17-6003-72	
Equilibration Tube Set for up to 24 cm IPG strips	12/pk	80-6467-79

Product	Quantity	Code No.
DeStreak rehydration reagents		
DeStreak Rehydration Solution	5 × 3 ml	17-6003-19
DeStreak Reagent	1 ml	17-6003-18
IPG Buffer, 1 ml		
pH 3.5–5.0		17-6002-02
pH 5.5–6.7		17-6002-06
pH 4–7		17-6000-86
pH 6–11		17-6001-78
pH 3–10		17-6000-87
pH 3–10 NL		17-6000-88
pH 7–11 NL		17-6004-39
pH 3–11 NL		17-6004-40
Pharmalyte, 25 ml		
pH 3–10		17-0456-01
pH 5–8		17-0453-01
pH 8–10.5		17-0455-01
Second-dimension products and accessories		
Mini-Vertical units and accessories		
miniVE complete, includes 3 rectangular glass plates, 3 notched plates, 2 gel modules, lid, lower buffer chamber, 2 each 1.0-mm thick 10 well combs and 1.0-mm thick spacer sets (glass plate size: 10 × 10.5 cm)		80-6418-77
Spacer, 1.0 mm	2/pk	80-6150-11
Spacer, 1.5 mm	2/pk	80-6150-30
SE 250 Mini-Vertical Unit, complete, for 2 slab gels (gel format 10 × 8 cm)		80-6147-45
SE 260 Mini II Vertical Unit, complete, for 2 slab gels (gel format 10 × 10.5 cm)		80-6149-35
SE 235 Mighty Small 4-Gel Caster, complete		80-6146-12
SE 245 Mighty Small Dual Gel Caster		80-6146-50
Wonder Wedge plate separation tool		80-6127-88
SE 600 Ruby Vertical Electrophoresis System and accessories		
SE 600 Ruby Dual Cooled Vertical Gel Unit for up to four gels (glass plate size: 18 × 16 cm)		80-6479-57
Spacer, 1.0 mm, 1 cm wide	2/pk	80-6179-94
Spacer, 1.0 mm, 2 cm wide	2/pk	80-6180-70
Spacer, 1.5 mm, 1 cm wide	2/pk	80-6180-13
Spacer, 1.5 mm, 2 cm wide	2/pk	80-6180-89
SE 615 Multiple Gel Caster for 2 to 10 gels (glass plate size: 18 × 16 cm)		80-6182-79
Glass plates, 18 × 8 cm	2/pk	80-6186-59
Glass plates, 18 × 8 cm low fluorescence	2/pk	80-6475-77
Divider glass plate, 18 × 8 cm, notched		80-6186-78
Glass plates, 18 × 16 cm	2/pk	80-6178-99
Glass plates, 18 × 16 cm low fluorescence	2/pk	80-6442-14
Divider glass plate, 18 × 16 cm, notched		80-6179-18
Clamp assembly, 8 cm	2/pk	80-6187-35
Clamp assembly, 16 cm	2/pk	80-6173-29

Product	Quantity	Code No.
Ettan DALT Large Vertical Systems and accessories		
Ettan DALTwelve Separation Unit and Power Supply/Control Unit, 115 VAC		80-6466-46
Ettan DALTwelve Separation Unit and Power Supply/Control Unit, 230 VAC		80-6466-27
Ettan DALTsix Separation Unit and Power Supply/Control Unit, 115 VAC		80-6485-08
Ettan DALTsix Separation Unit and Power Supply/Control Unit, 230 VAC		80-6485-27
Ettan DALTwelve Gel Caster, complete, includes 5 filler and 16 separator sheets (order cassettes separately)		80-6467-22
Ettan DALTsix Gel Caster, complete, includes 6 filler and 7 separator sheets (order cassettes separately)		80-6485-46
Ettan DALT Cassette Removal Tool	2/pk	80-6474-82
Ettan DALT Buffer Seal Removal Tool	2/pk	80-6474-63
Ettan DALT Precast Gel Cassette		80-6466-65
Ettan DALT Gel Casting Cassette, 1.0 mm (hinged cassette)		80-6466-84
Ettan DALT Gel Casting Cassette, 1.5 mm (hinged cassette)		80-6488-69
Ettan DALT Blank Cassette Insert		80-6467-03
Roller (for precast gels)		80-1106-79
Wonder Wedge plate separation tool (for lab-cast gels)		80-6127-88
Ettan DALT Separator Sheets 0.5 mm	16/pk	80-6467-41
Ettan DALT Filler Sheets 1.0 mm	6/pk	80-6467-60
Ettan DALT Cassette Rack	2/pk	80-6467-98
Ettan DALT Glass Plate Set, including spacers (standard glass plates for spot picking)	1 set of 2 pcs	80-6475-39
Ettan DALT Low Fluorescence Glass Plate Set, including spacers	1 set of 2 pcs	80-6475-58
Equilibration Tube Set	12	80-6467-79
Staining Tray Set		80-6468-17
Ettan DALTsix Gradient Maker		80-6487-36
DALT Gradient Maker with peristaltic pump, 115 V		80-6067-65
DALT Gradient Maker with peristaltic pump, 230 V		80-6067-84
DIGE gels and buffer kit		
DIGE gel	3	28-9374-51
DIGE Buffer Kit		28-9374-52
	2 × 125 ml anode buffer	
	4 × 125 ml cathode buffer	
	12 tubes agarose sealing solution	
Ettan DALT precast gels and buffer kit		
DALT Gel 12.5	6/pk	17-6002-36
DALT Buffer Kit		17-6002-50
Gradient makers		
SG15 Gradient Maker, 15 ml total volume		80-6197-61
SG 30 Gradient Maker, 30 ml total volume		80-6197-80
SG 50 Gradient Maker, 50 ml total volume		80-6197-99
SG 100 Gradient Maker, 100 ml total volume		80-6196-09
SG 500 Gradient Maker, 500 ml total volume		80-6198-18
Multiphor II Electrophoresis System		
Multiphor II Electrophoresis Unit		18-1018-06
Multiphor II Buffer Strip Positioner		80-6442-90
IEF sample application pieces	200/pk	80-1129-46

Product	Quantity	Code No.
Power supplies		
EPS 3501 XL Power Supply, 3500 V, 400 mA, 200 W		18-1130-05
EPS 2A200 Power Supply, 200 V, 2000 mA, 200 W		80-6406-99
EPS 301 Power Supply, 300 V, 400 mA, 80 W		18-1130-01
EPS 601 Power Supply, 600 V, 400 mA, 100 W		18-1130-02
EPS 1001 Power Supply, 1000 V, 400 mA, 100 W		18-1130-03
Thermostatic circulator		
MultiTemp III Thermostatic Circulator, 115 V		18-1102-77
MultiTemp III Thermostatic Circulator, 230 V		18-1102-78
ExcelGel SDS gels		
ExcelGel SDS 2-D Homogeneous 12.5	6/pk	17-6002-21
ExcelGel SDS Gradient XL 12-14	3/pk	17-1236-01
ExcelGel SDS Buffer Strips, anode and cathode	6 each/pk	17-1342-01
PlusOne chemicals and reagents		
Acrylamide PAGE (acrylic acid < 0.05%)	250 g	17-1302-01
Acrylamide PAGE (acrylic acid < 0.05%)	1 kg	17-1302-02
Acrylamide IEF (acrylic acid < 0.002%)	250 g	17-1300-01
Acrylamide IEF (acrylic acid < 0.002%)	1 kg	17-1300-02
Acrylamide IEF, 40% solution	1 l	17-1301-01
Acrylamide PAGE, 40% solution	1 l	17-1303-01
N,N'-methylenebisacrylamide	25 g	17-1304-01
N,N'-methylenebisacrylamide	100 g	17-1304-02
N,N'-methylenebisacrylamide, 2% solution	1 l	17-1306-01
ReadySol IEF, 40% T and 3% C	1 l	17-1310-01
Agarose NA	10 g	17-0554-01
Glycine	500 g	17-1323-01
Ammonium persulfate	25 g	17-1311-01
TEMED	25 ml	17-1312-01
Glycerol, 87%	1 l	17-1325-01
SDS	100 g	17-1313-01
Thiourea	100 g	RPN6301
Iodoacetamide	25 g	RPN6302
Tris	500 g	17-1321-01
Urea	500 g	17-1319-01
CHAPS	1 g	17-1314-01
Triton X-100	500 ml	17-1315-01
Dithiothreitol (DTT)	1 g	17-1318-01
Bromophenol Blue	10 g	17-1329-01
Bind-Silane	25 ml	17-1330-01
Immobiline DryStrip Cover Fluid	1 l	17-1335-01
Amberlite IRN-150L	500 g	17-1326-01
Enzymes		
Nuclease Mix	0.5 ml	80-6501-42
Deoxyribonuclease I (DNase I)	20 mg	27-0516-01
Ribonuclease I (RNase A and RNase B)	1 g	27-0330-02
Ribonuclease I "A" (RNase A)	100 mg	27-0323-01

Product	Quantity	Code No.
Molecular weight markers		
Peptide Marker Kit (M _r range 2512–16 949)		80-1129-83
LMW-SDS Marker Kit (M _r range 14 400–97 000)		17-0446-01
HMW-SDS Marker Kit (M _r range 53 000–220 000)		17-0615-01
Full-Range Rainbow Molecular Weight Markers		RPN800
pI calibration kit		
Carbamylyte Calibration Kit		17-0582-01
Automated gel and blot processing		
Processor Plus Base Unit (includes Base Unit, Reagent Tubing, and Protocol Key)		80-6444-04
Accessories to make functional for staining and/or blotting:		
Staining Tray Pack, 19 × 29 cm (complete with gel staining tray base, tray, and lid)		80-6444-80
Staining Tray Pack, 29 × 35 cm (includes gel staining tray base, tray, and lid)		80-6445-18
Blot Processing Tray Pack (includes tray base, disposable mini and standard trays, lid, reagent bottles and rack, and vented lid for waste products)		80-6444-23
Additional accessories for Processor Plus		
Stainless Steel Staining Tray 19 × 29 cm		80-6343-91
Stainless Steel Staining Tray 29 × 35 cm		80-6345-24
Blot Processing Mini Tray	3/pk	80-6444-42
Blot Processing Standard Tray	3/pk	80-6444-61
Manual gel staining		
Stainless Steel Staining Tray Set		80-6468-17
Staining reagents		
Silver Staining Kit, Protein		17-1150-01
Coomassie tablets, PhastGel Blue R-350		17-0518-01
Deep Purple Total Protein Stain (sufficient for two large-format gels or 20 minigels)		RPN6305
Deep Purple Total Protein Stain (sufficient for 10 large-format gels or 100 minigels)		RPN6306
Gel dryers		
GD 2000 Vacuum Gel Dryer for gels up to 33 × 44 cm, 115 V		80-6428-84
GD 2000 Vacuum Gel Dryer for gels up to 33 × 44 cm, 230 V		80-6429-03
Cellophane Sheets		80-6117-81
Image analysis systems and software		
Image Scanner III		28-9076-07
Typhoon FLA 9000		28-9558-08
ImageMaster 2D Platinum		18-1176-30
ImageMaster 2D Platinum site license		18-1176-31
See also under 2-D DIGE products		

Product	Quantity	Code No.
Spot handling		
Ettan Spot Picker		18-1145-28
Ettan Digester		18-1142-68
2-D DIGE products		
CyDye DIGE Fluor Minimal Dye Labeling Kit (includes Cy2, Cy3, and Cy5) (5nmol)		25-8010-65
CyDye DIGE Fluor Cy2 minimal dye, 5 nmol		25-8010-82
CyDye DIGE Fluor Cy2 minimal dye, 10 nmol		25-8008-60
CyDye DIGE Fluor Cy2 minimal dye, 25 nmol		RPK0272
CyDye DIGE Fluor Cy3 minimal dye, 5 nmol		25-8010-83
CyDye DIGE Fluor Cy3 minimal dye, 10 nmol		25-8008-61
CyDye DIGE Fluor Cy3 minimal dye, 25 nmol		RPK0273
CyDye DIGE Fluor Cy5 minimal dye, 5 nmol		25-8010-85
CyDye DIGE Fluor Cy5 minimal dye, 10 nmol		25-8008-62
CyDye DIGE Fluor Cy5 minimal dye, 25 nmol		RPK0275
CyDye DIGE Fluor Labeling Kit for Scarce Samples (for a minimum of 12 labeling reactions)		25-8009-83
CyDye DIGE Fluor Labeling Kit for Scarce Samples plus Preparative Gel Labeling (for minimum of 12 labeling reactions and 1 prep gel)		25-8009-84
CyDye DIGE Fluor Preparative Gel Labeling Kit for Scarce Samples		28-9366-83
CyDye DIGE Kit, 2 nmol		28-9345-30
DIGE Trial pack: CyDye DIGE Kit, 2 nmol + DeCyder 1-month trial license		28-9373-73
Ettan DIGE Gel Alignment Guides for SE600		80-6496-29
Ettan DIGE Gel Alignment Guides for Ettan DALT		80-6496-10
Imaging systems		
Typhoon Variable Mode Imagers		
Typhoon FLA 9000	1	28-9558-08
Typhoon FLA 7000	1	28-9558-09
Typhoon 9400	1	63-0055-78
Typhoon 9410	1	63-0055-80
Typhoon Trio	1	63-0055-87
Typhoon Trio+	1	63-0055-89
ImageQuant™ imagers		
ImageQuant LAS 4000	1	28-9558-10
ImageQuant LAS 4010	1	28-9558-11
ImageQuant LAS 4000 mini	1	28-9558-13
Other imaging systems		
ImageScanner III	1	28-9076-07
Storm 820 and ImageQuant TL	1	28-9328-12
Storm 845 and ImageQuant TL	1	28-9326-41
Storm 865 and ImageQuant TL	1	28-9327-91

Product	Quantity	Code No.
Analysis software		
ImageQuant TL		
ImageQuant TL, single user license	1	28-9236-62
ImageQuant TL, 5-user network license	1	28-9206-39
ImageQuant TL, 10-user network license	1	28-9236-57
ImageQuant TL 7.0 and ImageQuant TL SecurITy 8.0 Software Package (with Getting Started Guide)	1	28-9380-94
ImageQuant TL 7.0 and ImageQuant TL SecurITy 8.0, single user license	1	28-9332-73
ImageMaster 2D Platinum		
ImageMaster 2D Platinum 7.0 DIGE, 1 license	1	28-9380-55
ImageMaster 2D Platinum 7.0 upgrade to DIGE, 1 license	1	28-9398-10
ImageMaster 2D Platinum 7.0, 1 license	1	28-9380-91
ImageMaster 2D Platinum 6.0 upgrade to 7.0, 1 license	1	28-9399-70
ImageMaster 2D Platinum 7.0 software package	1	28-9408-30
DeCyder 2D		
DeCyder 2D Oracle 10gR2, 5 user license	1	28-9435-88
DeCyder 2D 7.0, 1-user license	1	28-9442-75
DeCyder 2D 7.0, additional 1-user license	1	28-9442-77
DeCyder 2D 7.0, 1-user trial license	1	28-9442-79
DeCyder 2D 7.0, 1-user license (upgrade from 6.5 2D)	1	28-9442-80
DeCyder 2D 7.0, 1-user license (upgrade from 6.5 + EDA)	1	28-9442-81
DeCyder 2D 7.0, pre-installed computer 1-user license (computer with DeCyder pre-installed, Software Package, and e-license, 1 user node locked)	1	28-9435-86
DeCyder 2D 7.0 Software Package, (Installation Guide, Getting Started Guide, and DeCyder 2D DVD case with installation disc packaged in DeCyder box)	1	28-9435-83
DeCyder 2D 7.1 SPN, 1-user license	1	29-9763-18
DeCyder 2D 7.1 SPN, 1-user trial license	1	28-9763-20
DeCyder 2D 7.1 SPN, 1-user license (upgrade from 2D 7.0)	1	28-9763-21
DeCyder 2D 7.1 SPN Software Package, (Installation Guide, Getting Started Guide, and DeCyder 2D DVD case with installation disc packaged in DeCyder box)	1	28-9757-78

Recommended additional consumables

Sulfobetaines		Calbiochem
PefaBloc		Merck
DMF (N,N'-dimethylformamide) 99.8% anhydrous	22,705-6	Sigma-Aldrich
Crew Wipes	Z23681-0	Sigma-Aldrich
L-lysine	L-5626	Sigma-Aldrich
Molecular Sieves 4Å	M2635	Sigma-Aldrich
Decon 90	cln 010	010 M.J. Patterson (Scientific) Ltd.

GE, imagination at work, and GE monogram are trademarks of General Electric Company.

Cy, CyDye, DeCyder, Deep Purple, ECL, Ettan, ExcelGel, Hybond, illustra, ImageMaster, ImageQuant, ImageScanner, Immobililine, IPGphor, Multiphor, MultiTemp, Personal Densitometer, Pharmalyte, Rainbow, Scierra, and Typhoon are trademarks of GE Healthcare companies.

2-D Fluorescence Difference Gel Electrophoresis (2-D DIGE) technology is covered by US patent numbers 6,043,025, 6,127,134 and 6,426,190 and equivalent patents and patent applications in other countries and exclusively licensed from Carnegie Mellon University. CyDye: this product or portions thereof is manufactured under an exclusive license from Carnegie Mellon University under US patent numbers 5,569,587, 5,627,027 and equivalent patents in other countries. The purchase of CyDye DIGE Fluors includes a limited license to use the CyDye DIGE Fluors for internal research and development, but not for any commercial purposes. A license to use the CyDye DIGE Fluors for commercial purposes is subject to a separate license agreement with GE Healthcare.

CyDye: This product or portions thereof is manufactured under an exclusive license from Carnegie Mellon University under US patent number 5,268,486 and equivalent patents in the US and other countries. The purchase of CyDye products includes a limited license to use the CyDye products for internal research and development but not for any commercial purposes. A license to use the CyDye products for commercial purposes is subject to a separate license agreement with GE Healthcare. Commercial use shall include:

1. Sale, lease, license or other transfer of the material or any material derived or produced from it.
2. Sale, lease, license or other grant of rights to use this material or any material derived or produced from it.
3. Use of this material to perform services for a fee for third parties, including contract research and drug screening.

If you require a commercial license to use this material and do not have one, return this material unopened to GE Healthcare Bio-Sciences AB, Björkgatan 30, SE-751 84 Uppsala, Sweden and any money paid for the material will be refunded.

DeCyder: This release of DeCyder (software) is provided by GE Healthcare to the customer under a nonexclusive license and is subject to terms and conditions set out in the 2-D Differential Gel Electrophoresis Technology Access Agreement. Customer has no rights to copy or duplicate or amend the Software without the prior written approval of GE Healthcare.

Deep Purple Total Protein Stain is exclusively licensed to GE Healthcare from Fluorotechnics Pty Ltd. Deep Purple Total Protein Stain may only be used for applications in life science research. Deep Purple is covered under a granted patent in New Zealand entitled "Fluorescent Compounds", patent number 522291 and equivalent patents and patent applications in other countries.

DIGE Gel and DIGE Buffer Kit: The buffer system in this gel and buffer kit is covered by patent application WO9616724 granted in US, EP and JP.

Ettan CAF MALDI Sequencing Kits are protected by patents owned by Procter & Gamble Company and exclusively licensed to GE Healthcare Bio-Sciences AB and by joint patents issued to both companies. The purchase of Ettan CAF MALDI Sequencing Kits includes a limited license to use the technology for internal research and development, but not for any commercial purposes. No right to perform or offer commercial services or products of any kind using the Sequencing Kits is hereby granted. A license to use the technology for commercial purposes is subject to a separate license agreement with GE Healthcare Bio-Sciences AB. Please contact the Product Director, Mass Spectrometry and Sample Handling, GE Healthcare Bio-Sciences AB, Björkgatan 30, SE-75184, Uppsala, Sweden for details about how to obtain such a license.

This version of ImageMaster has been developed by the Swiss Institute of Bioinformatics in collaboration with GeneBio and GE Healthcare.

All third party trademarks are the property of their respective owners.

© 2010 General Electric Company—All rights reserved.

All goods and services are sold subject to the terms and conditions of sale of the company within GE Healthcare which supplies them. A copy of these terms and conditions is available on request. Contact your local GE Healthcare representative for the most current information.

GE Healthcare UK Limited Amersham Place
Little Chalfont
Buckinghamshire, HP7 9NA
UK

GE Healthcare Europe, GmbH
Munzinger Strasse 5
D-79111 Freiburg
Germany

GE Healthcare Bio-Sciences Corp.
800 Centennial Avenue, P.O. Box 1327
Piscataway, NJ 08855-1327
USA

GE Healthcare Bio-Sciences KK
Sanken Bldg., 3-25-1, Hyakunincho
Shinjuku-ku, Tokyo 169-0073
Japan

For local office contact information,
please visit www.gelifesciences.com/contact

www.gelifesciences.com/protein-purification

GE Healthcare Bio-Sciences AB
Björkgatan 30
751 84 Uppsala
Sweden

