

ARTIFICIAL ORGANS

- BLOOD PUMPS
- ASSIST DEVICES
- EXTRACORPOREAL
CIRCULATION
- TOTAL ARTIFICIAL HEART

Selected Bibliography

**BIOMECHANICS OF
ARTIFICIAL ORGANS AND
PROSTHESES**

Artificial Organs

Gerald E. Miller
Virginia Commonwealth University

Shunei Kyo
Editor

Ventricular Assist Devices
in Advanced-Stage
Heart Failure

Megh R. Goyal, PhD, PE, and Vijay K. Goyal, PhD

SYNTHESIS LECTURES ON BIOMEDICAL ENGINEERING #4

Apple Academic Press
TORONTO NEW JERSEY

 Springer

CRC Press
Taylor & Francis Group
6000 Broken Sound Parkway NW, Suite 300
Boca Raton, FL 33487-2782

Apple Academic Press, Inc
3333 Mistwell Crescent
Oakville, ON L6L 0A2
Canada

 MORGAN & CLAYPOOL PUBLISHERS

ISBN 978-4-431-54465-4 ISBN 978-4-431-54466-1 (eBook)
DOI 10.1007/978-4-431-54466-1
Springer Tokyo Heidelberg New York Dordrecht London

© 2014 by Apple Academic Press, Inc.
Exclusive worldwide distribution by CRC Press an imprint of Taylor & Francis Group, an Informa
business

No claim to original U.S. Government works
Version Date: 20140117

International Standard Book Number-13: 978-1-4822-3157-1 (eBook - PDF)

The heart: two double chamber pulsed pumps in series

- Left heart responsible for peripheral circulation. High hydraulic resistance, high pressure load
- Right heart responsible for pulmonary circulation. Low hydraulic resistance, low pressure load
- Atrio-ventricular node (AVN) is the pacemaker stimulating contraction of ventricular myocardium
- Sinoatrial node (SAN) stimulates atrial tissue contraction

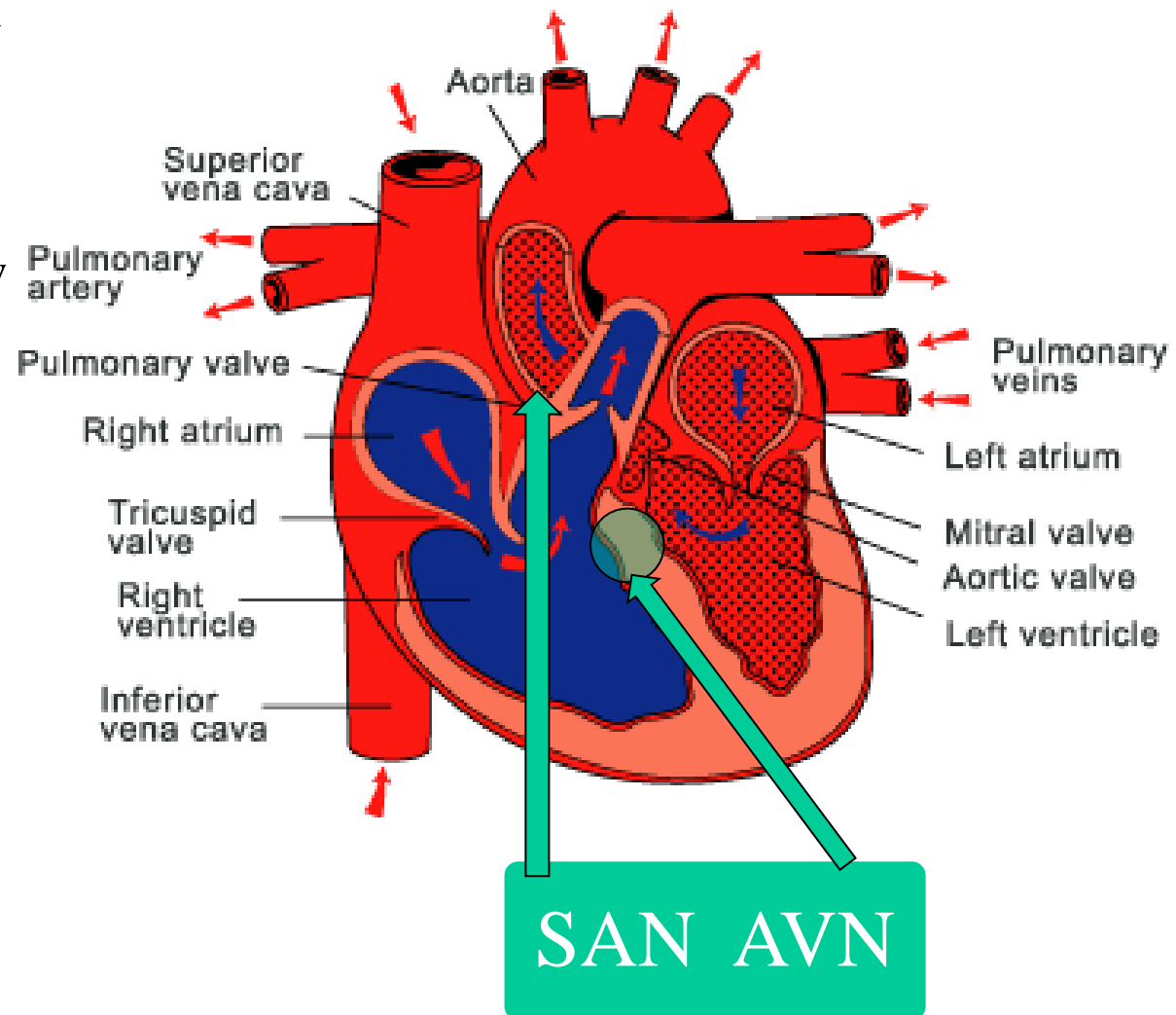

Cardiac function

Left heart

- Diastole
 1. Myocardial relaxation
 2. Opening – closing of valves
 3. Atrial contraction: blood ejected to ventricle
- Systole
 1. Isovolumetric myocardial contraction
 2. Closing-opening of valves
 3. Blood ejection to aorta
- Isovolumetric myocardial relaxation

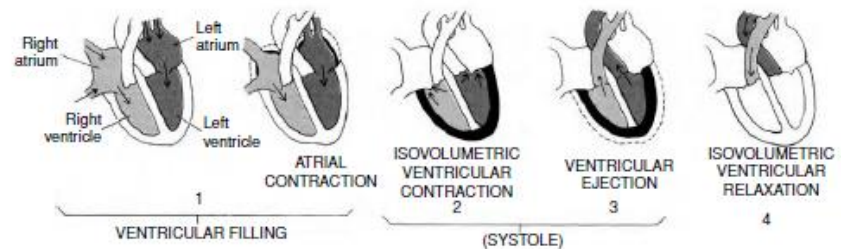
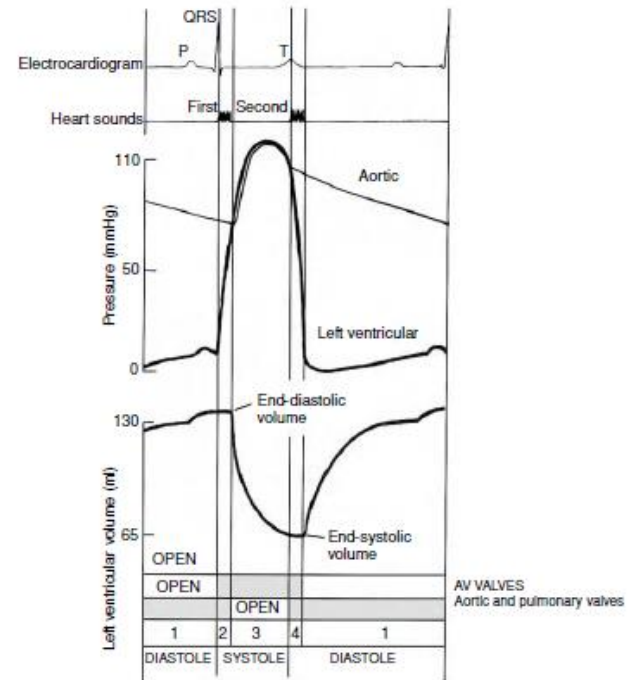

Electrical stimulation

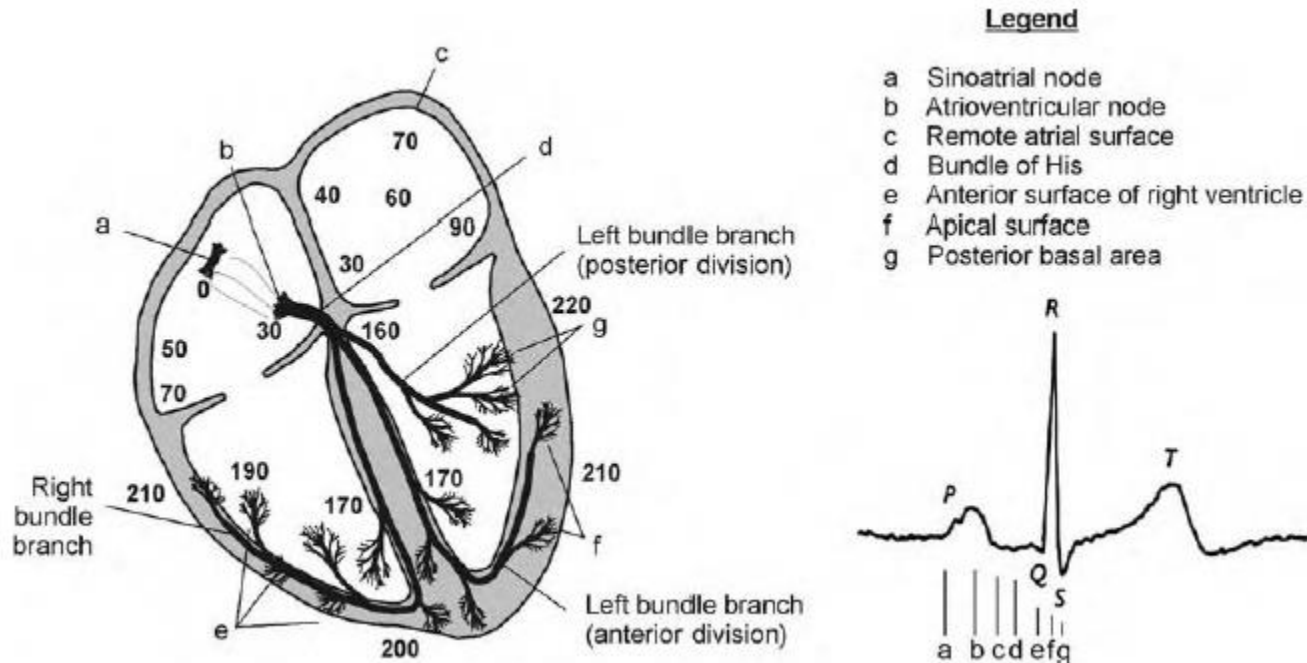

- Myocardial contraction or relaxation depends on the relevant electrical pulse
- Permanent arrhythmias problems result in pacemaker implantation (subdermal)

P-V diagram of cardiac function

- a: Ventricular filling. Work from blood to ventricle
- b: isovolumetric contraction. No work
- c: Injection. Work from ventricle to blood
- d: Isovolumetric relaxation. No work
- ESV: End systolic volume
- EDV: End diastolic volume
- SV: Stroke volume = EDV - ESV
- Injection fraction: ESV/EDV

$$W = \oint p dV$$

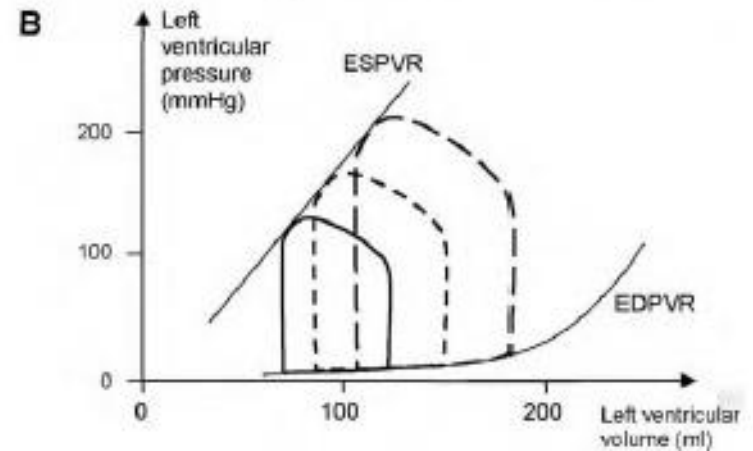
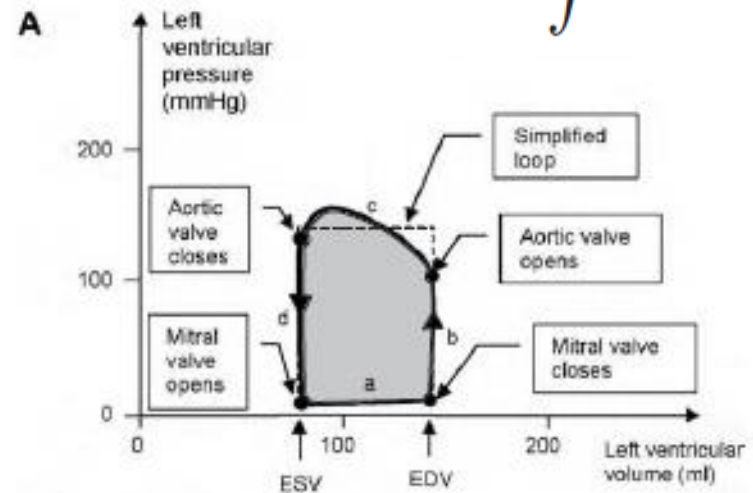

Surgical operations using artificial organ implantation

- Arrhythmias: Pacemaker
- Myocardial problems (temporary) (defibrillator)
- Open heart: Heart lung machine
- Ventricular assist devices: Right or left (RVAD, LVAD)
- Total artificial heart (TAH)

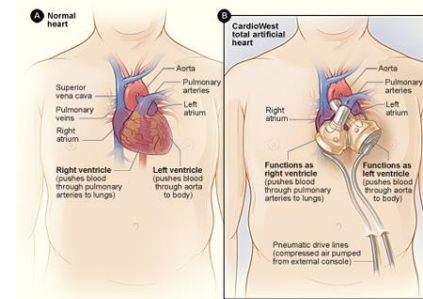
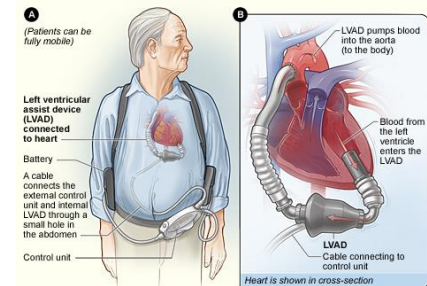
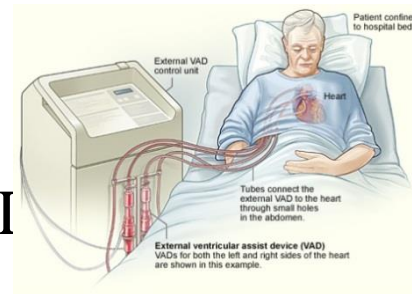
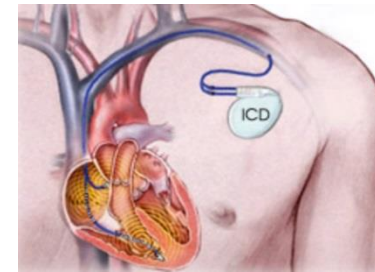
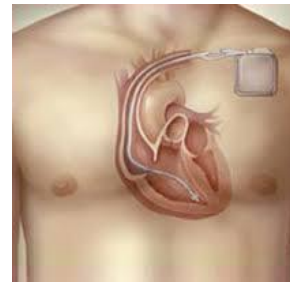

Heart lung machine in function

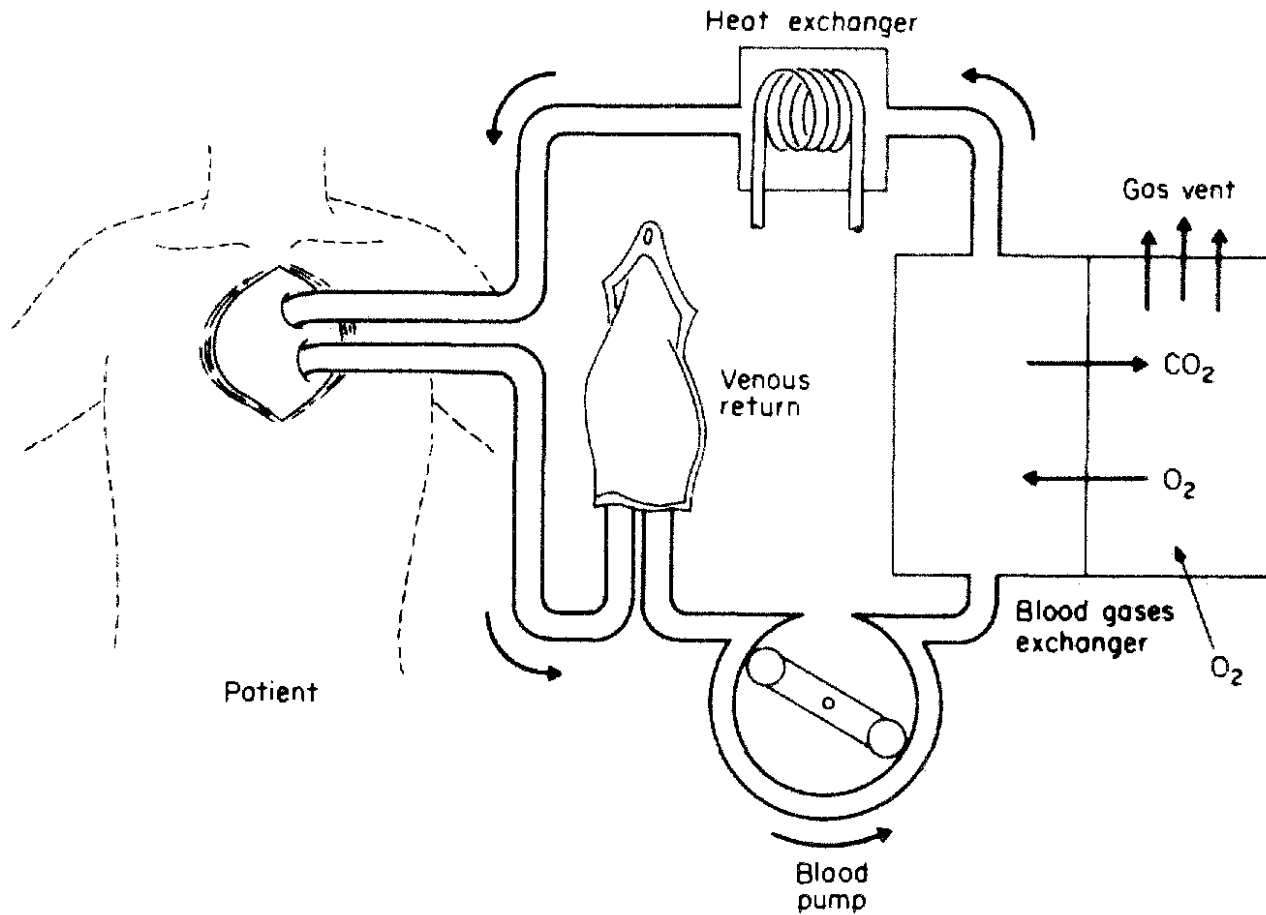
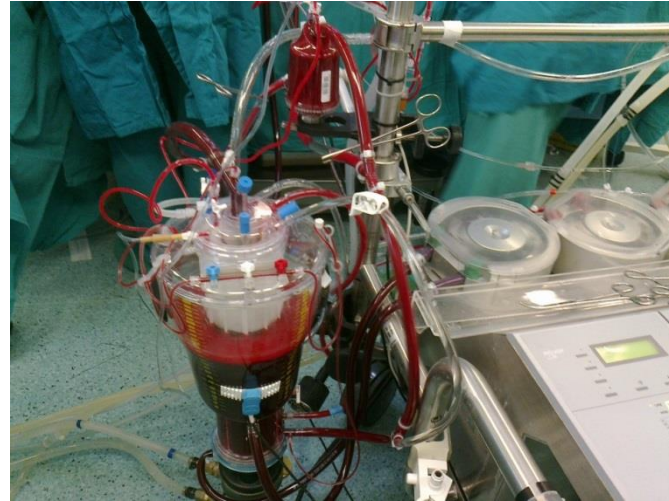

FIG. 11. Circuitry for heart-lung bypass.

Heart lung machine (Univ. Patras)



- Extracorporeal circulation: cardiac isolation from blood circulation, blood oxygenation
- Peristaltic
- Application of cryo-plegia and recovery
- Blood heparinization to avoid thrombus formation
- Air bubble entrapping systems

Hikaru Matsuda (Ed.)

Rotary Blood Pumps

New Developments
and Current Applications

With 72 Figures, Including 1 in Color



Springer

Fluid Engineering Aspect for Development of the Centrifugal Blood Pump with Magnetically Suspended Impeller

TERUAKI AKAMATSU¹, TOMONORI TSUKIYA², and TAKAYOSHI OZAKI³

Engineering Development of
Rotary Blood Pumps

Centrifugal LVAD - RVAD

Rotary centrifugal LVAD

Rotary centrifugal LVADs have two sealed chambers: a pump chamber that moves the blood; and a motor chamber which contains the mechanism that drives the pump. Power is transmitted between the chambers by magnetism.

Two tubes leaving the pump chamber carry the blood between the LVAD and the heart. Blood enters near the top center of the pump and leaves from the side.

The third tube to the motor chamber contains the wires to power the unit.

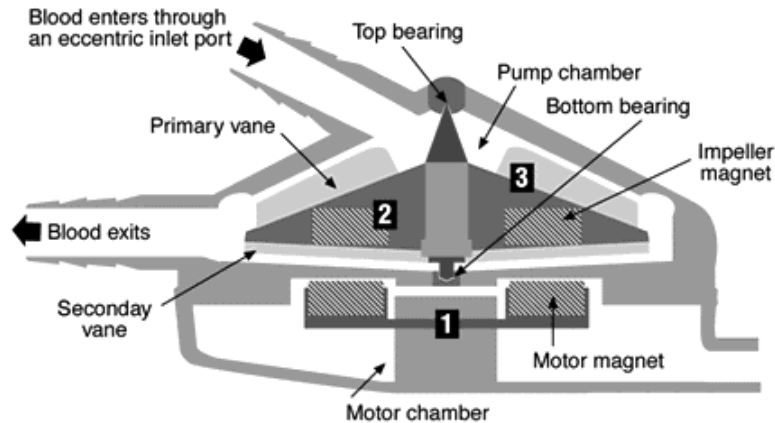

- 1** An electric motor turns a pair of magnets in the motor chamber.
- 2** The magnets turn magnets in the pump chamber.
- 3** The pump chamber magnets are attached to vanes that move the blood through the pump.

PROS Smaller than pulsatile, so more promise for use in women and children ■ Less mechanical wear than the axial flow ■ Low energy requirement ■ Easier to manufacture

CONS No long-term experience in humans ■ Larger than axial flow pumps ■ Continuous flow is significantly different from natural heart action; physiologic effects not totally understood.

Rotational-centrifugal design

Blood damage

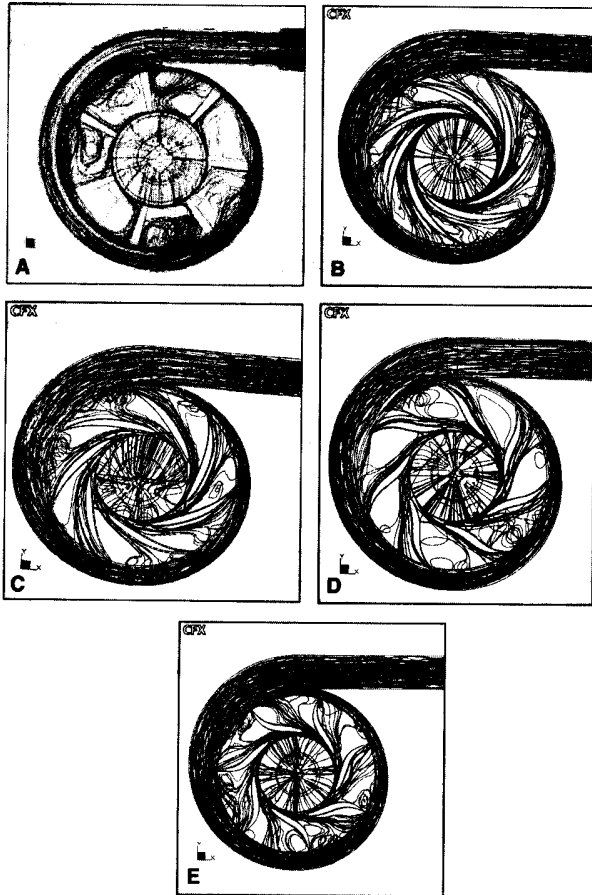

FIG. 6. Shown are traces of particles in the radial impeller (A); traces of particles of Design 1 (B); traces of particles of Design 2 (C); traces of particles of Design 3 (D); and traces of particles of Design 4 (E).

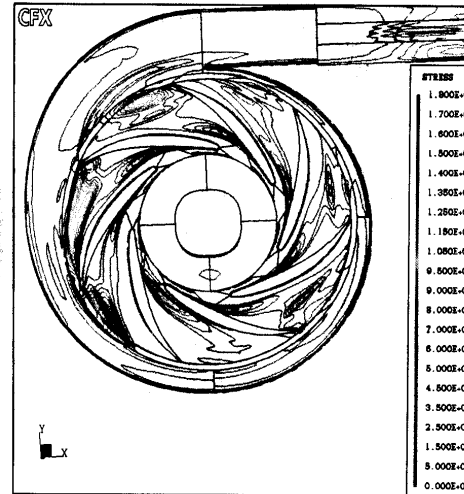

FIG. 5. Shear stress contours are shown in Design 2.

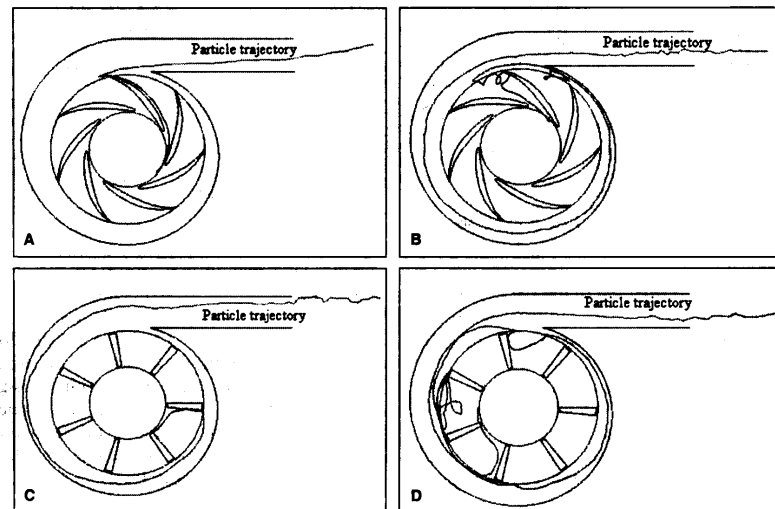

FIG. 8. Shown is trajectory of Particle 29 (Design 2) (A); trajectory of Particle 92 (Design 2) (B); trajectory of Particle 10 (radial blade) (C); and trajectory of Particle 88 (radial blade) (D).

Rotational-centrifugal design

Blood damage

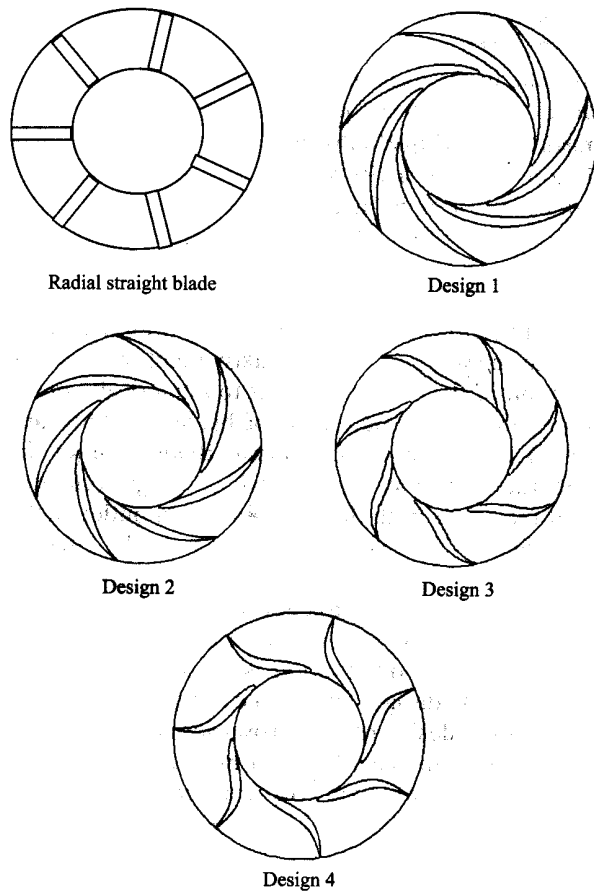

FIG. 1. Blade profiles for the impeller designs are shown.

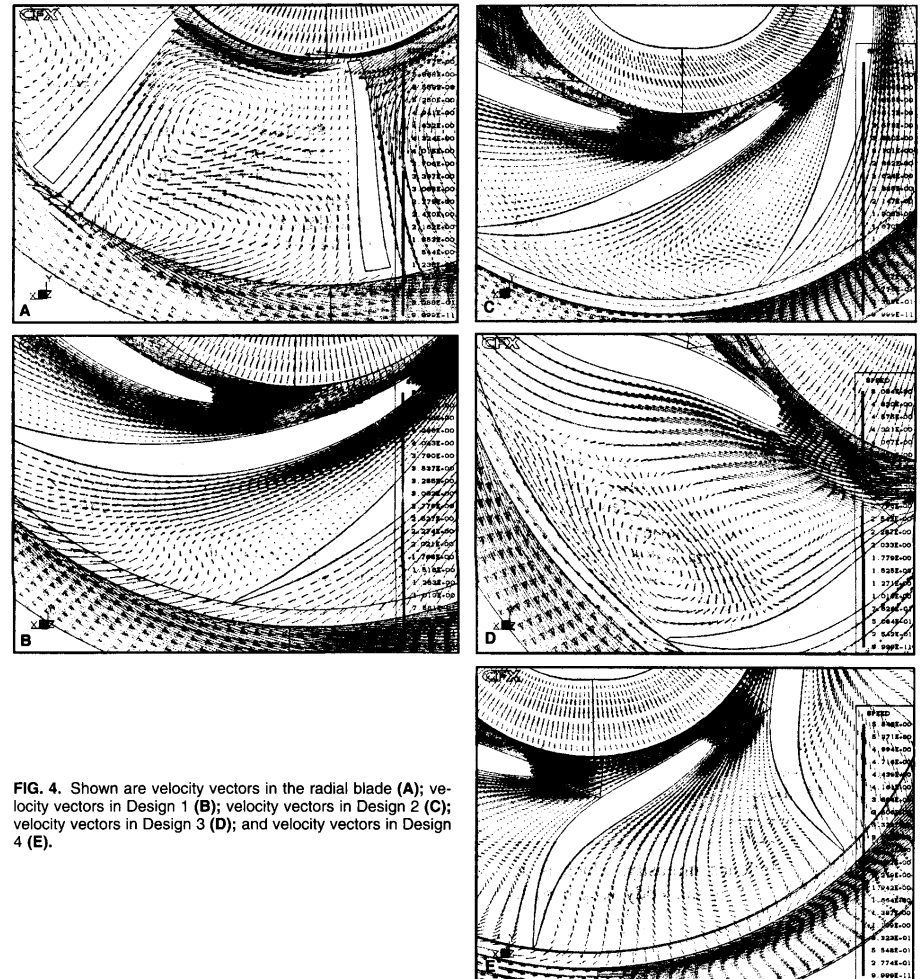

FIG. 4. Shown are velocity vectors in the radial blade (A); velocity vectors in Design 1 (B); velocity vectors in Design 2 (C); velocity vectors in Design 3 (D); and velocity vectors in Design 4 (E).

HEARTMATE

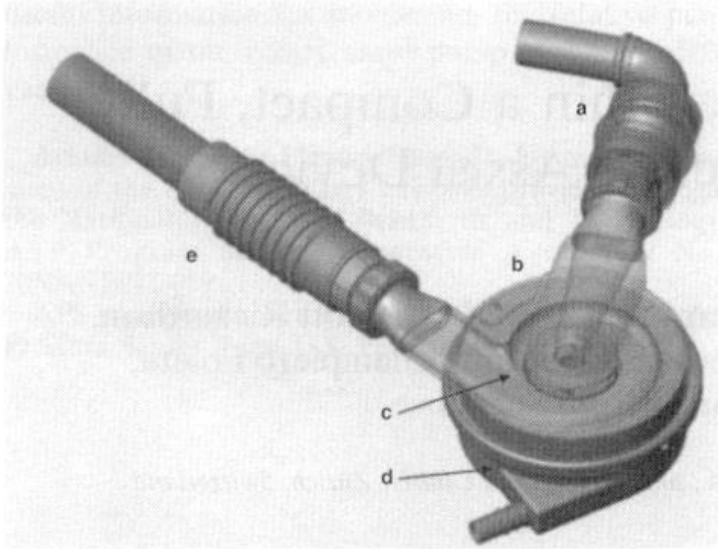

FIG. 1. Shown is the HeartMate III inflow (a), pump (b), rotor (c), motor (d), and outflow (e).

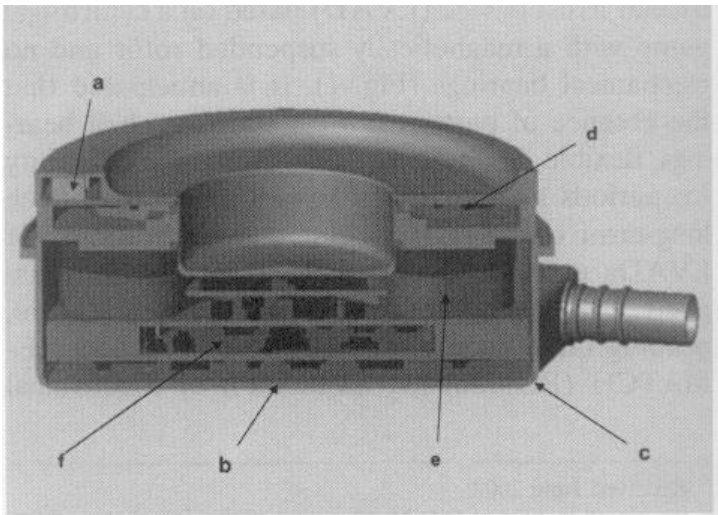
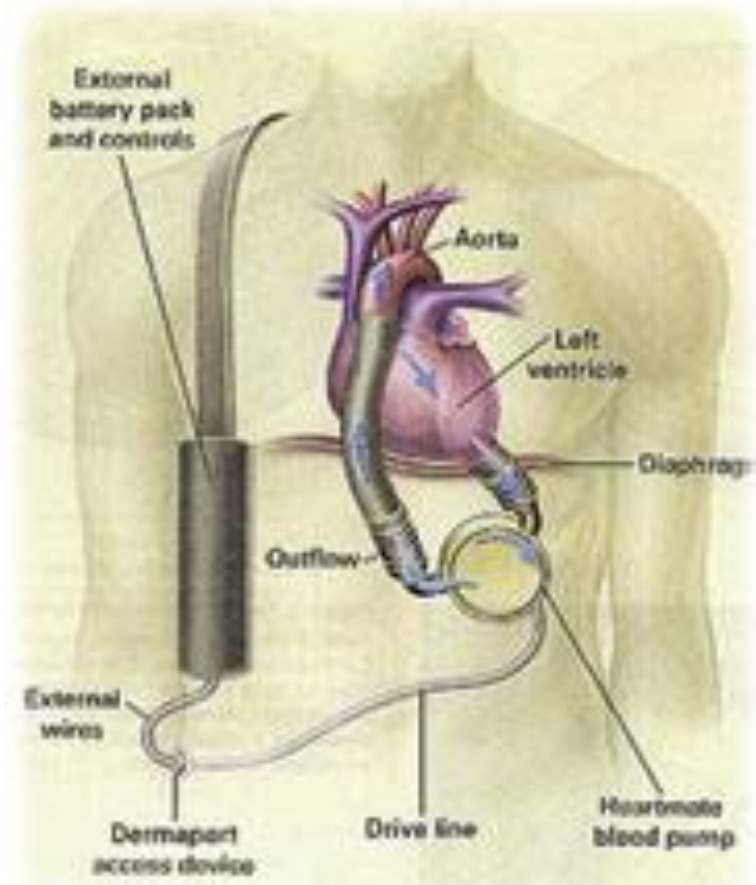

FIG. 3. Section view of the HeartMate III lower housing and motor are shown: spiral cavity outside of, and in plane with, the volute (a), base plate (b), radius around the bottom corner of the pump (c), stator iron (d), motor and levitation coils (e), implanted electronics (f).



Blood pumps

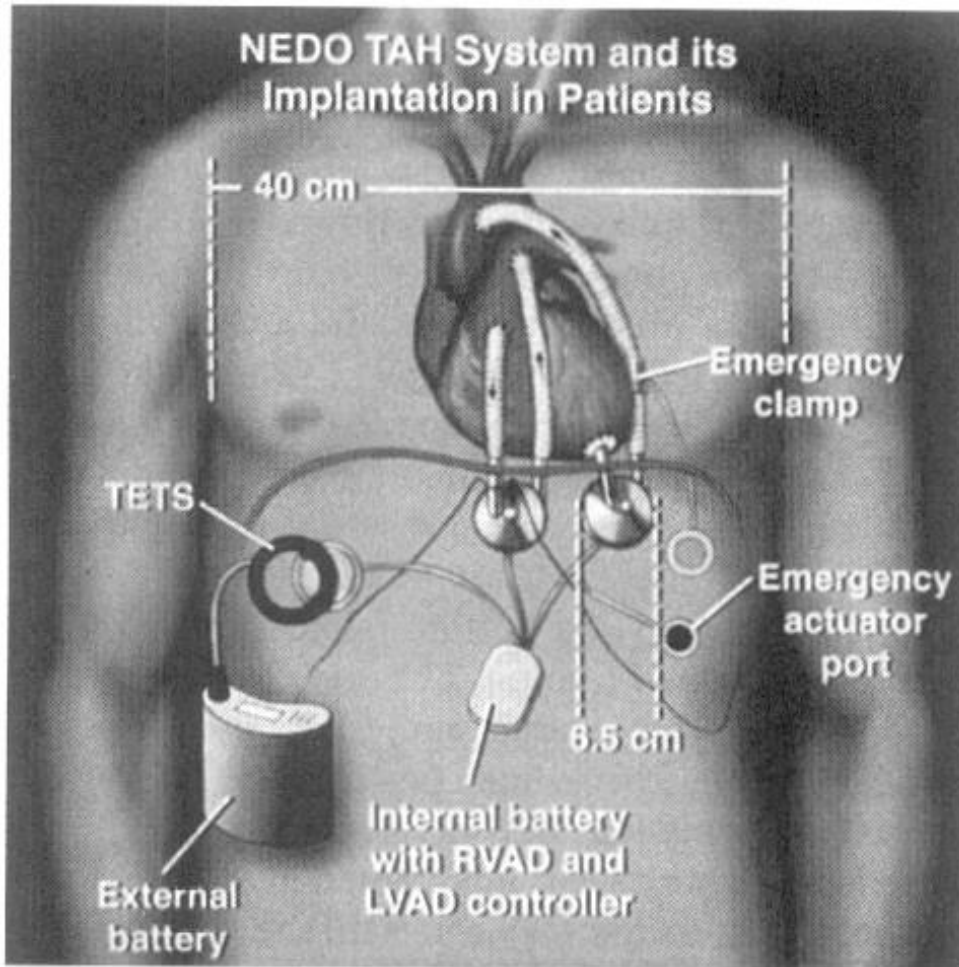

FIG. 4. Totally implantable NEDO BVAD system is shown.

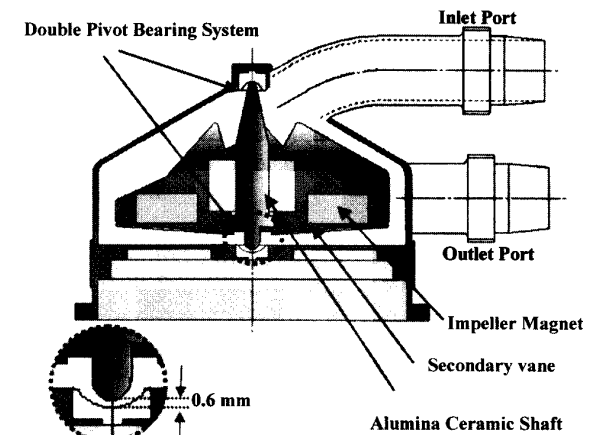
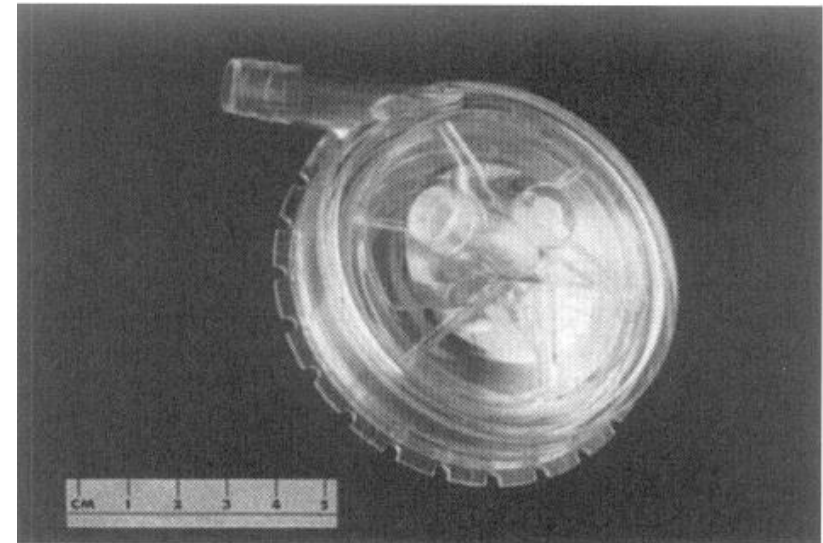

FIG. 3. Shown is a schematic diagram of the NEDO Gyro centrifugal blood pump.

Pulsed-diaphragm R-LAD

Pulsatile electromagnetic LVAD

Electric pulsatile LVADs have two sealed chambers: a pump chamber that moves the blood; and a motor chamber which contains the mechanism that drives the pump. A diaphragm with a flexible membrane keeps the two chambers apart.

Two tubes leaving the pump chamber carry the blood between the LVAD and the heart. Two porcine valves determine which tube carries blood to the LVAD and which carries blood away.

The tube to the motor chamber contains the wires to power the unit, and an air hose connected to an implanted compliance chamber that allows the diaphragm to go up and down without resistance.

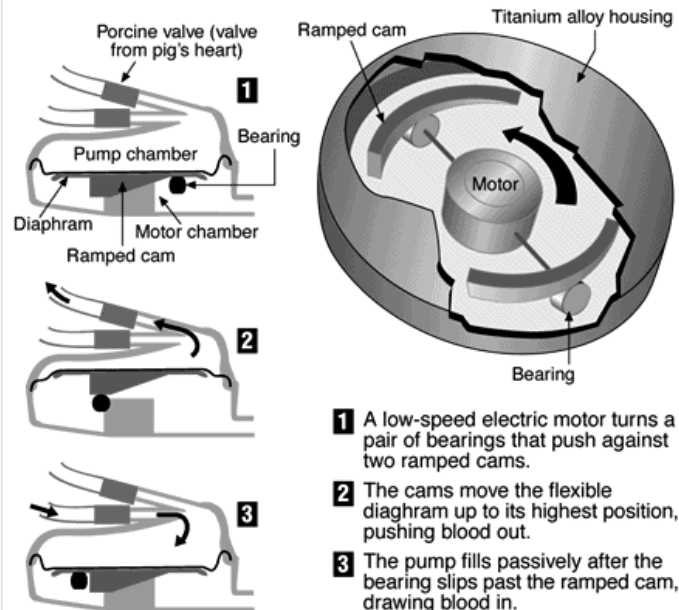

PROS Mimics the natural heart rhythm ■ Long-term experience with similar devices in humans

CONS Too large for many women and all children ■ If completely contained within the body, needs an extra chamber for air expelled in the pumping action ■ Complicated system contains many stress points where pump can fail

NOVACOR LVAS

• Stroke volume: 70 ml

- Bridge to transplantation
- Bioprosthetic valves
- **1)** Fill- to empty mode
- 2) Fixed - rate mode
- 3) synchronized mode

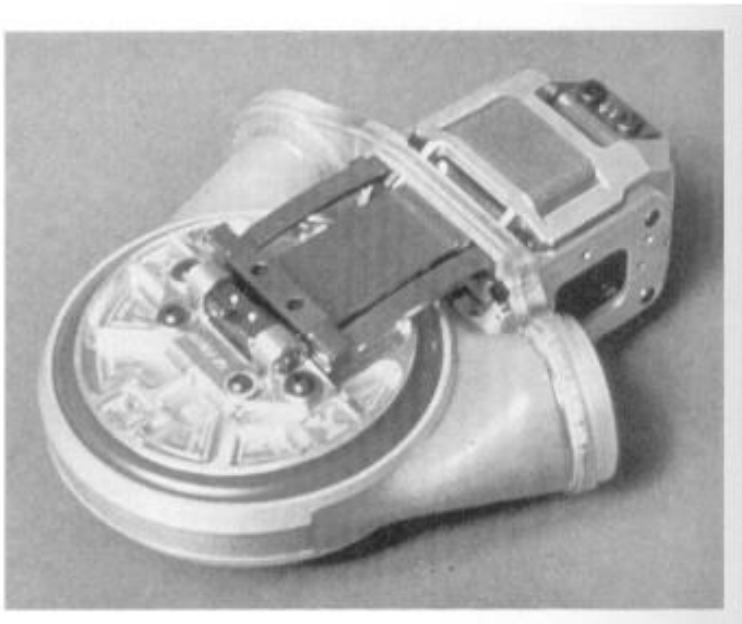

LVAD VERSUS

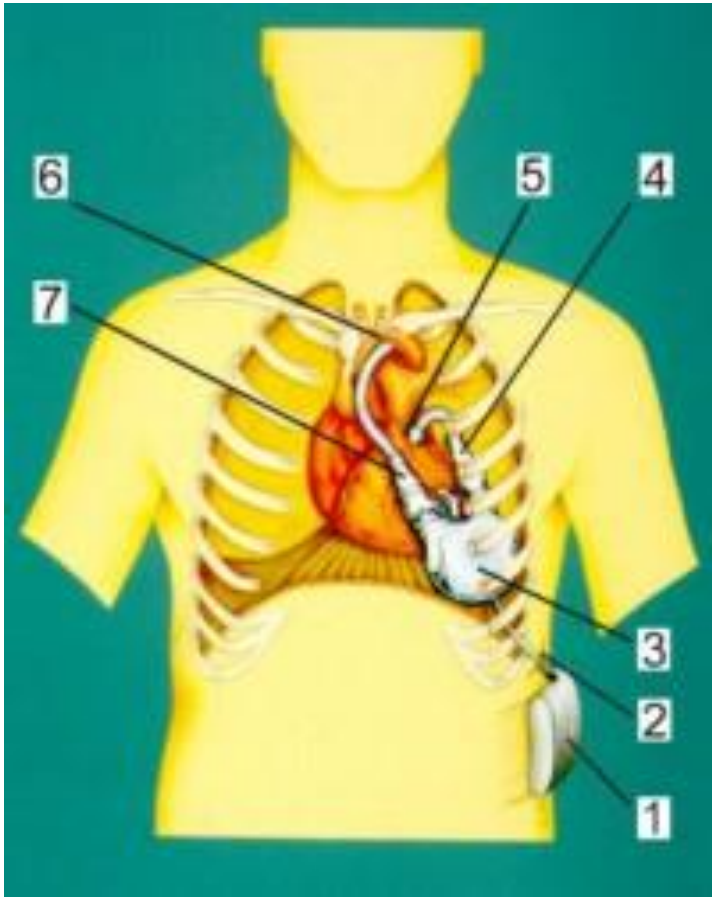

VERSUS IV - in calf



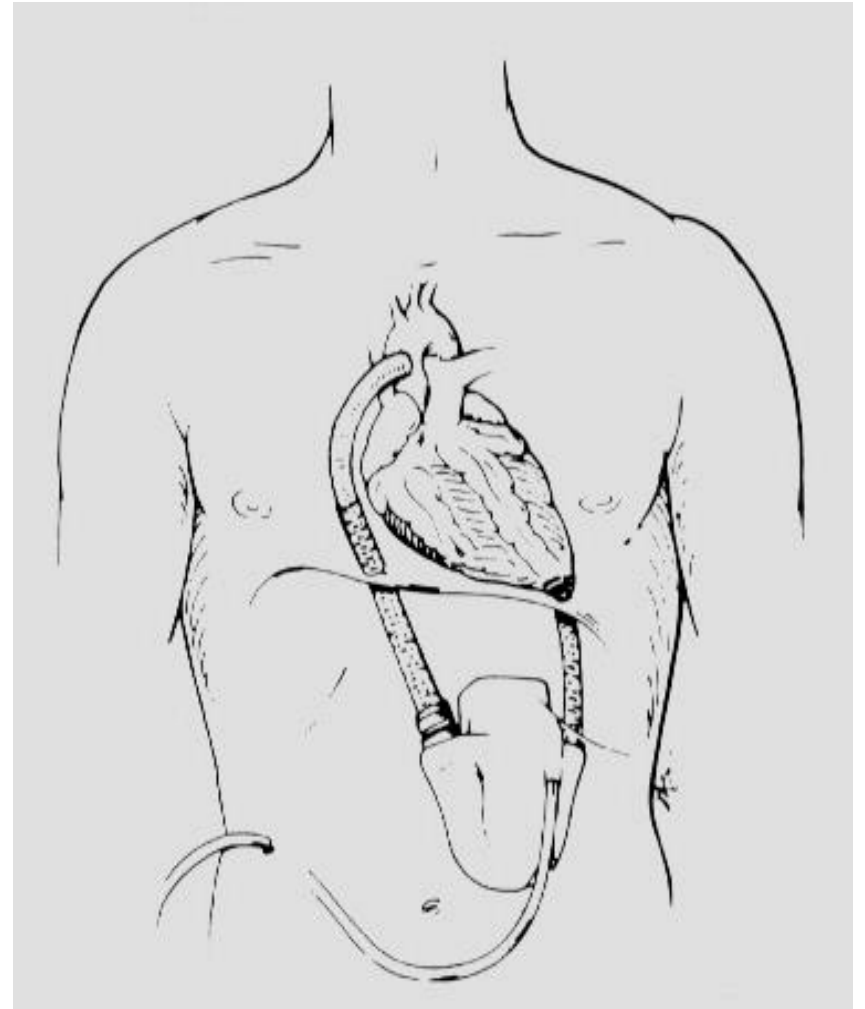
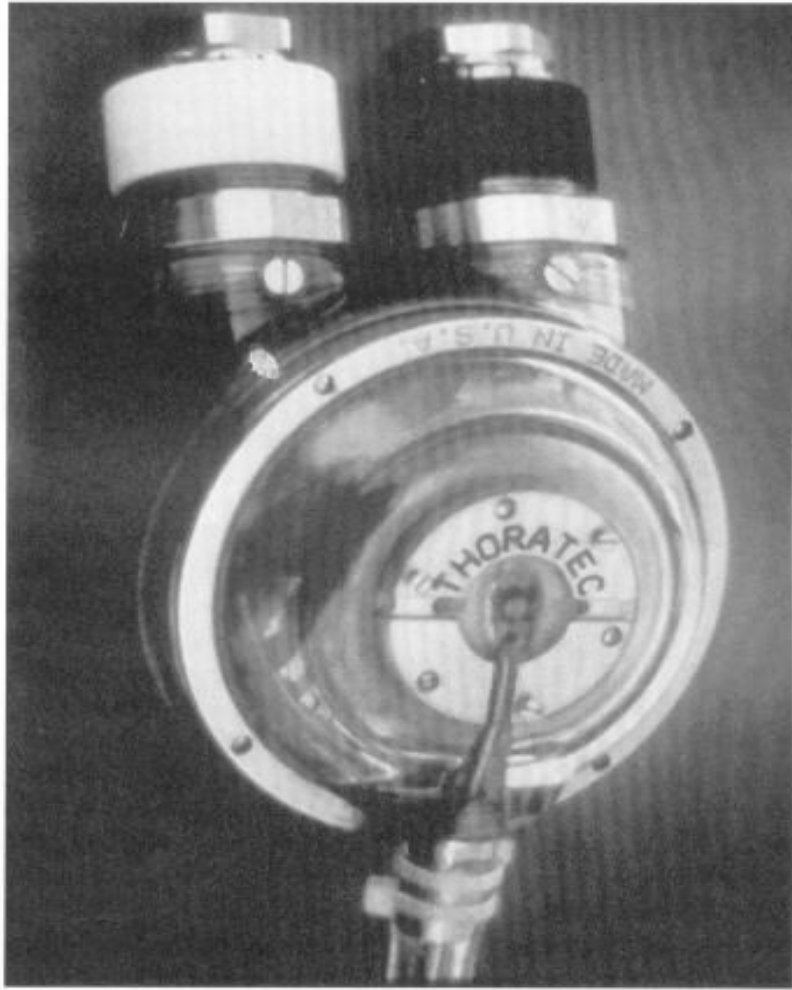

HeartMate

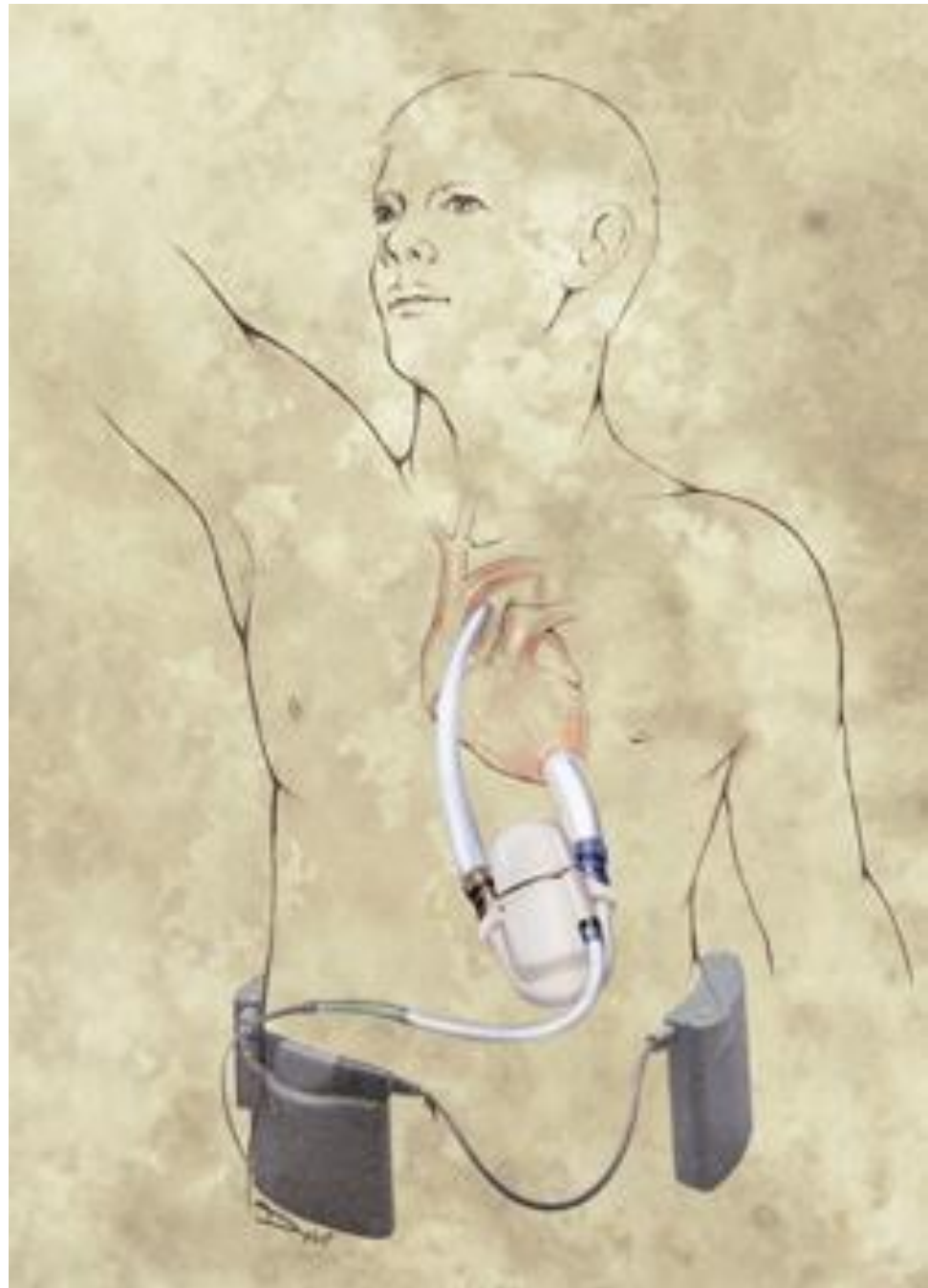

The human heart

Your selfish heart
 The heart supplies itself with oxygenated blood before delivering it to any other part of the body. The coronary arteries (not shown) branch off the aorta immediately after it leaves the heart.



- The heart is a hollow muscle about the size of a fist.
- It pumps more than 4,300 gallons of blood through 100,000 miles of vessels daily.
- The heart beats more than 80,000 times a day, about 2.5 billion times in a lifetime.

← Oxygenated blood
 → Deoxygenated blood

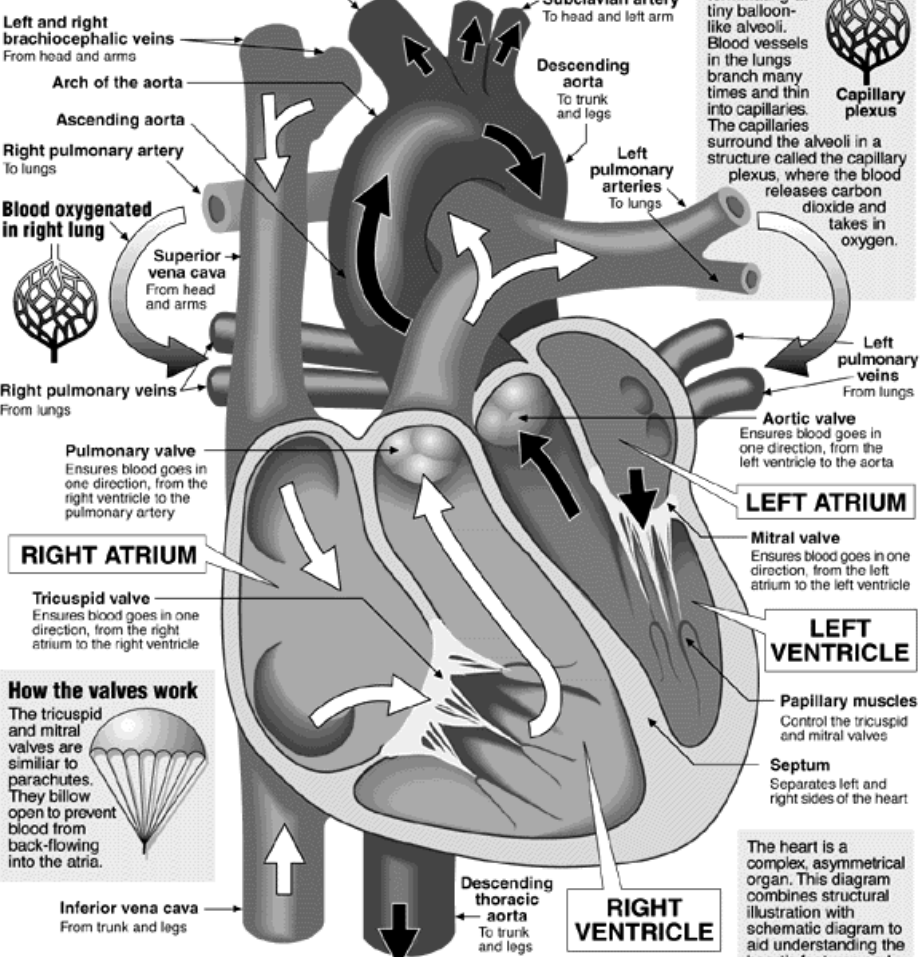

Oxygenating blood
 The bronchi in the lungs branch and thin many times, terminating at tiny balloon-like alveoli. Blood vessels in the lungs branch many times and thin into capillaries. The capillaries surround the alveoli in a structure called the capillary plexus, where the blood releases carbon dioxide and takes in oxygen.



How the valves work
 The tricuspid and mitral valves are similar to parachutes. They billow open to prevent blood from back-flowing into the atria.



Rotary axial flow LVAD

This valve-less heart-assist pump is no bigger than a "C" battery. The turbine device pumps oxygenated blood throughout the body. The electrically powered pump does not beat or pulse like a real heart. In this case, the pump fits into the left ventricle. Other pumps are implanted in the chest or abdomen.

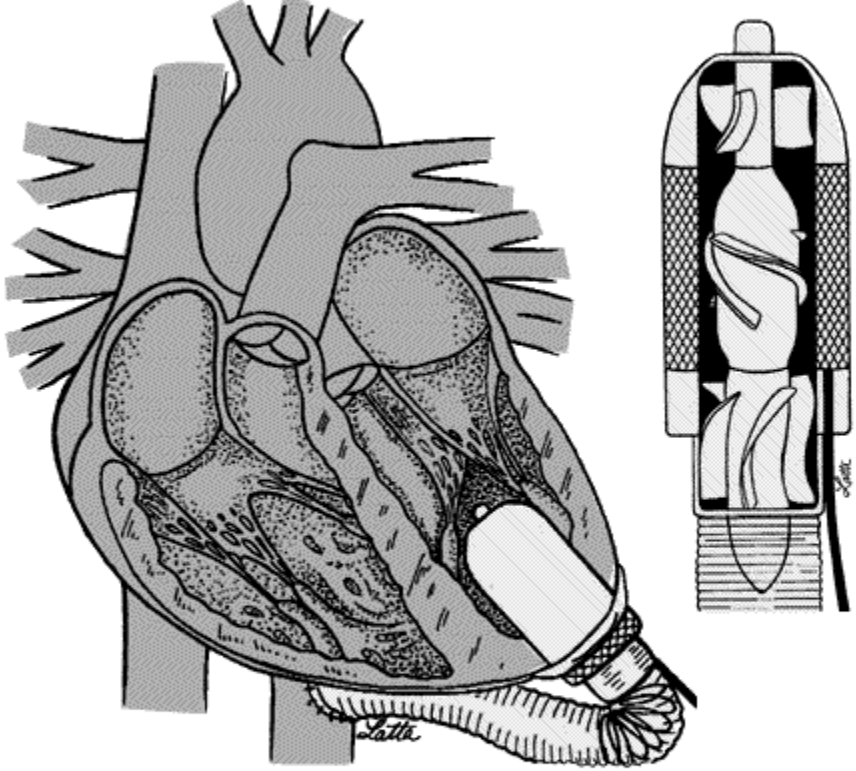

- PROS** Smallest of the three; some models can be implanted within the ventricle ■ Low energy requirement ■ High output of blood
- CONS** Bearings can wear out quickly unless properly lubricated or suspended ■ High speed of pump can destroy red blood cells unless impeller is carefully designed ■ Must be manufactured to strict tolerances for pump to be effective ■ No long-term experience in humans

Sources: Knight-Ridder Tribune, Encyclopedia Britannica, Atlas of Human Anatomy, Atlas of Medical Anatomy, Gray's Anatomy, Melloni's Illustrated Medical Dictionary

Source: Texas Heart Institute

Rotary-axial pumps

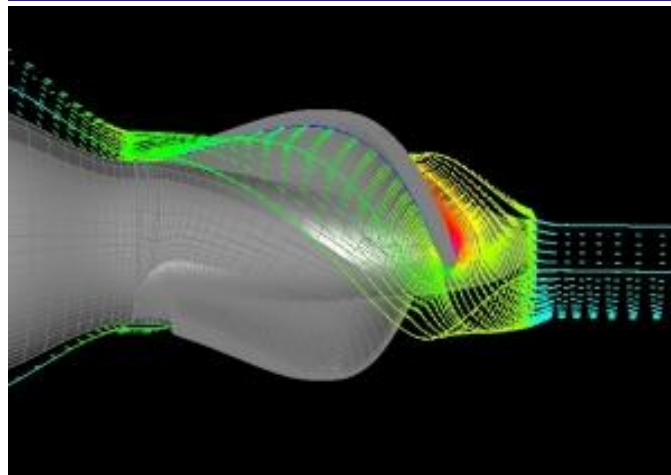
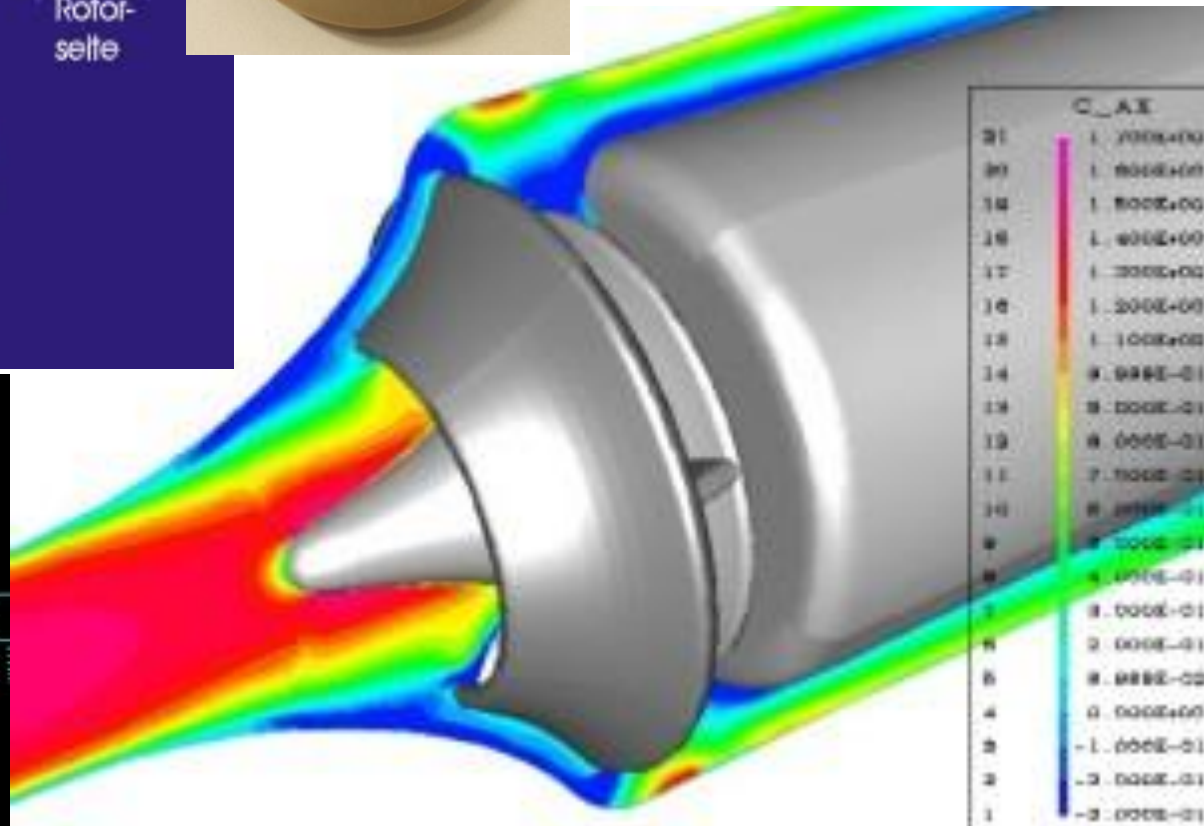
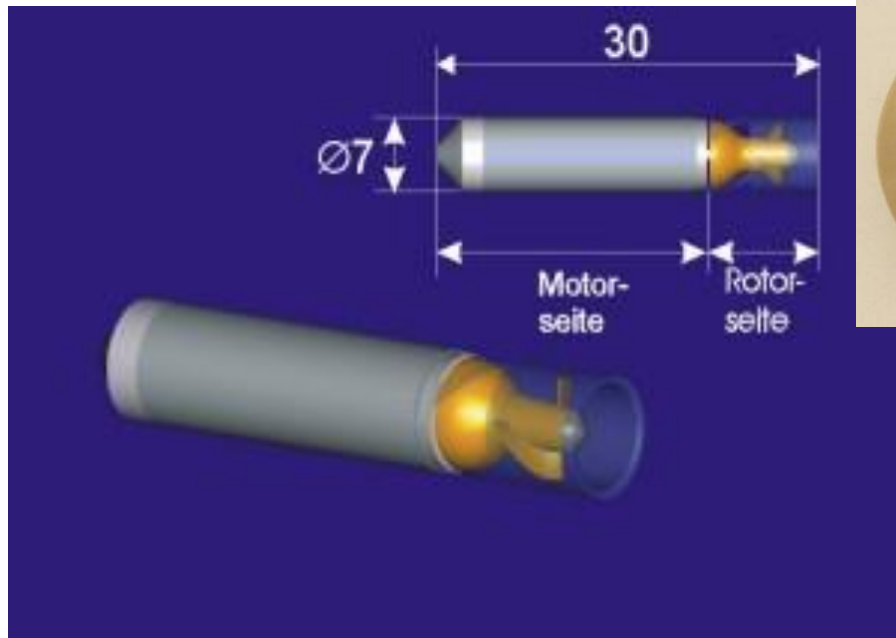

JARVIK 2000

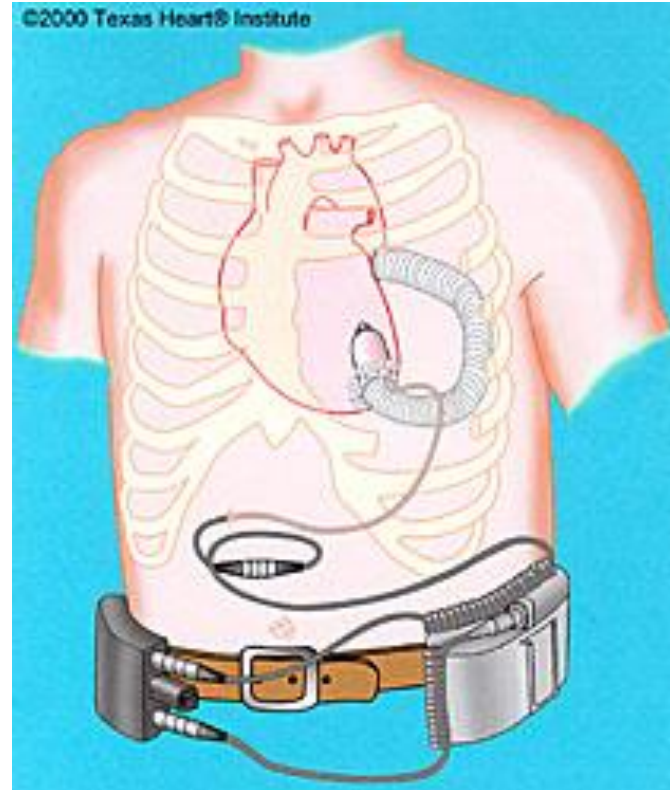

DELTA STREAM

Diagonal Pumps



Intracorporeal

Extracorporeal

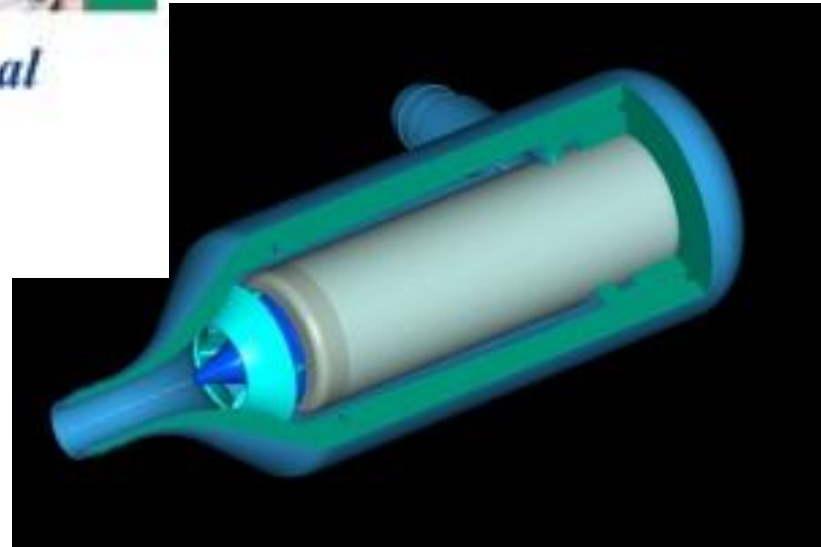

Electric (BERLIN)

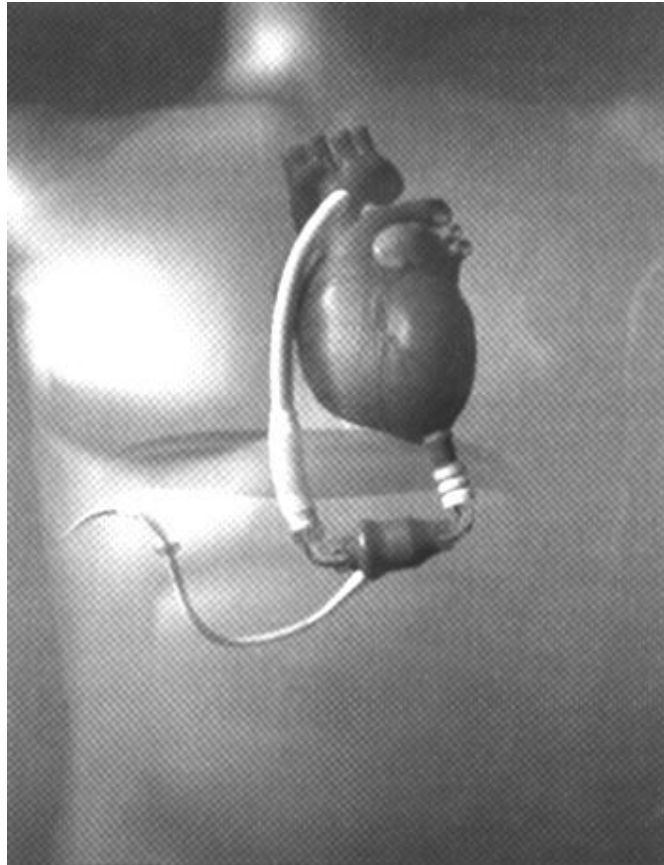

Catheter pumps: implantation

Pump is placed in left ventricle

- Through femoral artery (less invasive)
- Through ascending aorta (invasive)

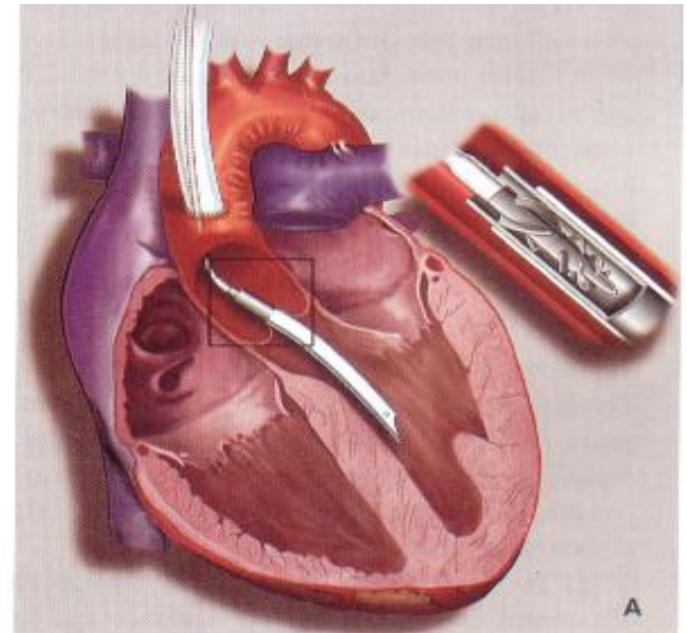

Powering the heart pumps

Most totally implanted heart pumps will be powered by rechargeable, external batteries. A pair of coils, known as a transcutaneous energy transmission device, is used for power transfer across the intact skin, eliminating wires going through the skin and avoiding the risk of infection. One coil is implanted under the skin and a ringlike coil is strapped over it outside the body.

When showering, the battery packs and external coil can be removed and the pump works off an internal battery.

Heart pumps draw blood from the apex of the left ventricle with the opening directed toward the mitral valve. The blood is pumped into the ascending aorta and circulates throughout the body.

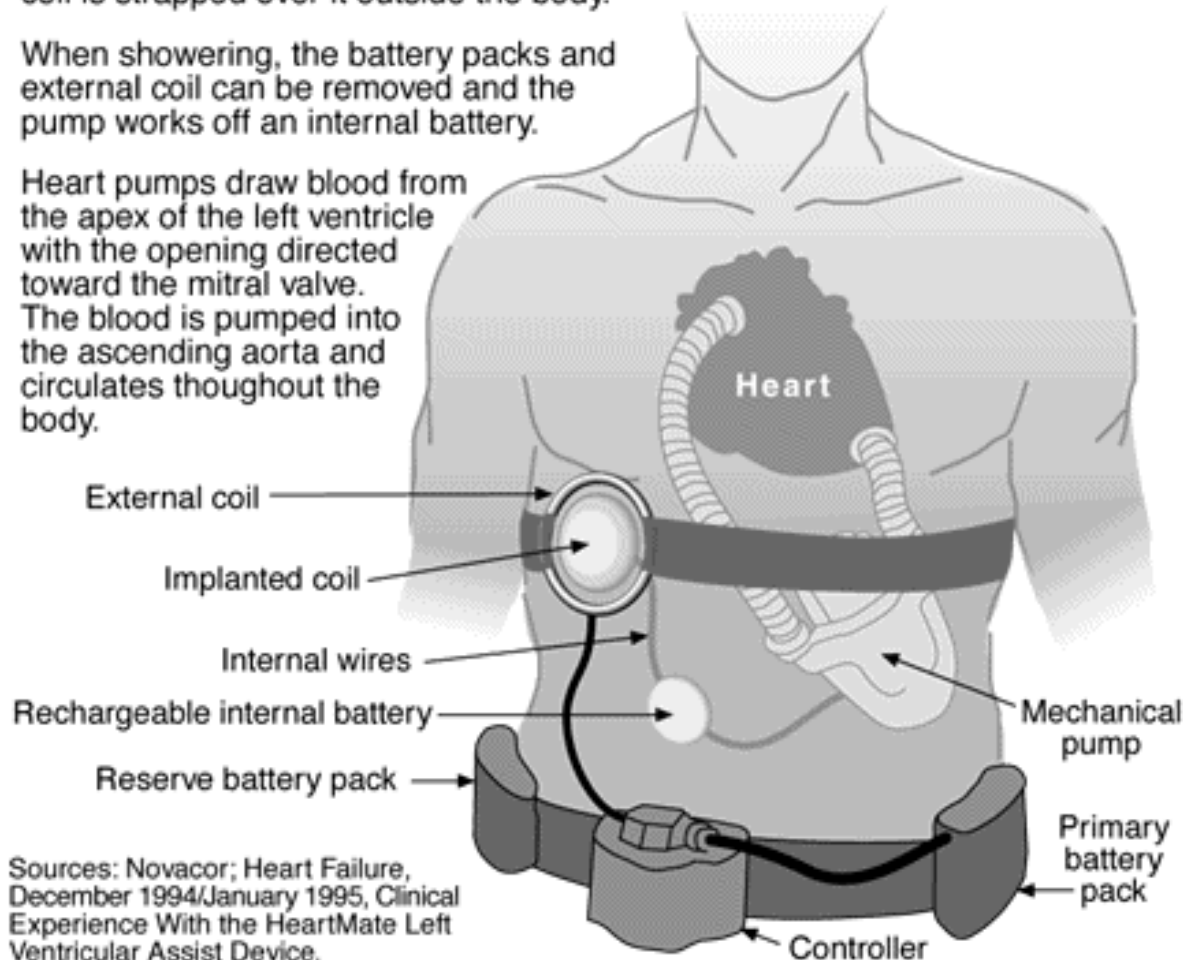

Sources: Novacor; Heart Failure, December 1994/January 1995, Clinical Experience With the HeartMate Left Ventricular Assist Device.

Skeletal muscle pumps

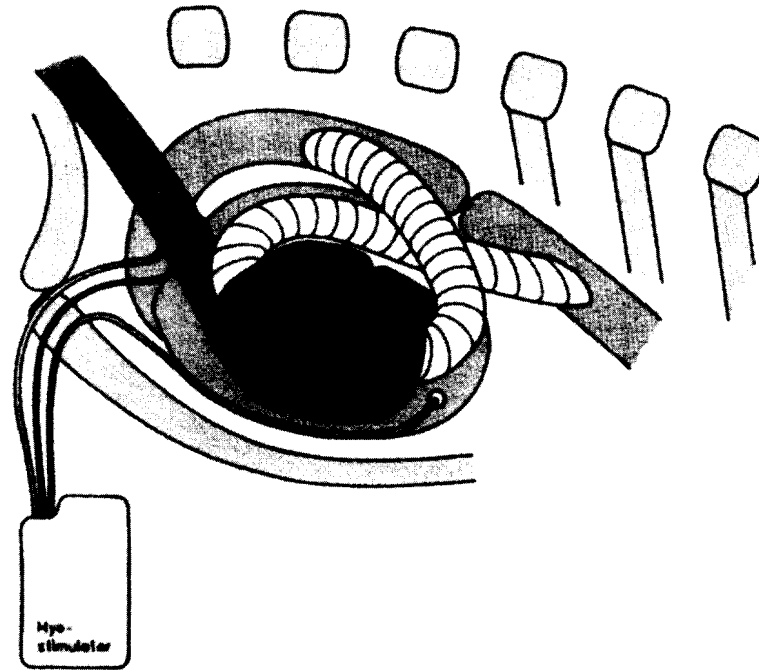

FIG. 2. Topography of a biomechanical heart in aorta-descendens position in a goat is shown. The aorta is ligated between the two anastomoses.

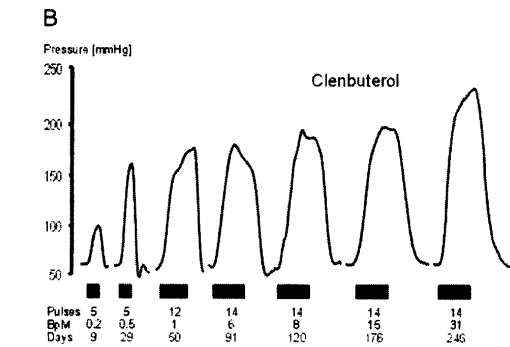
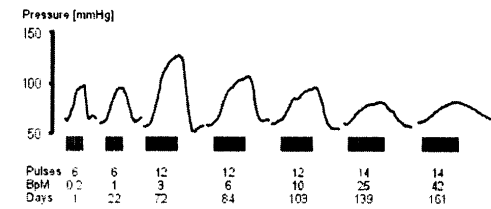
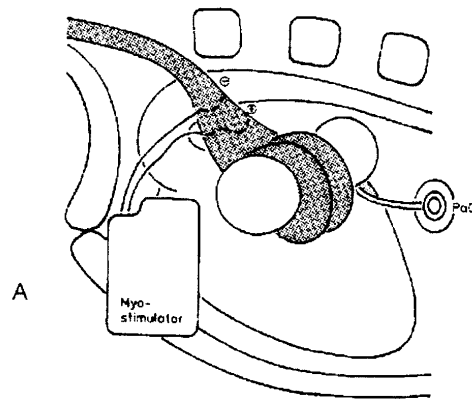
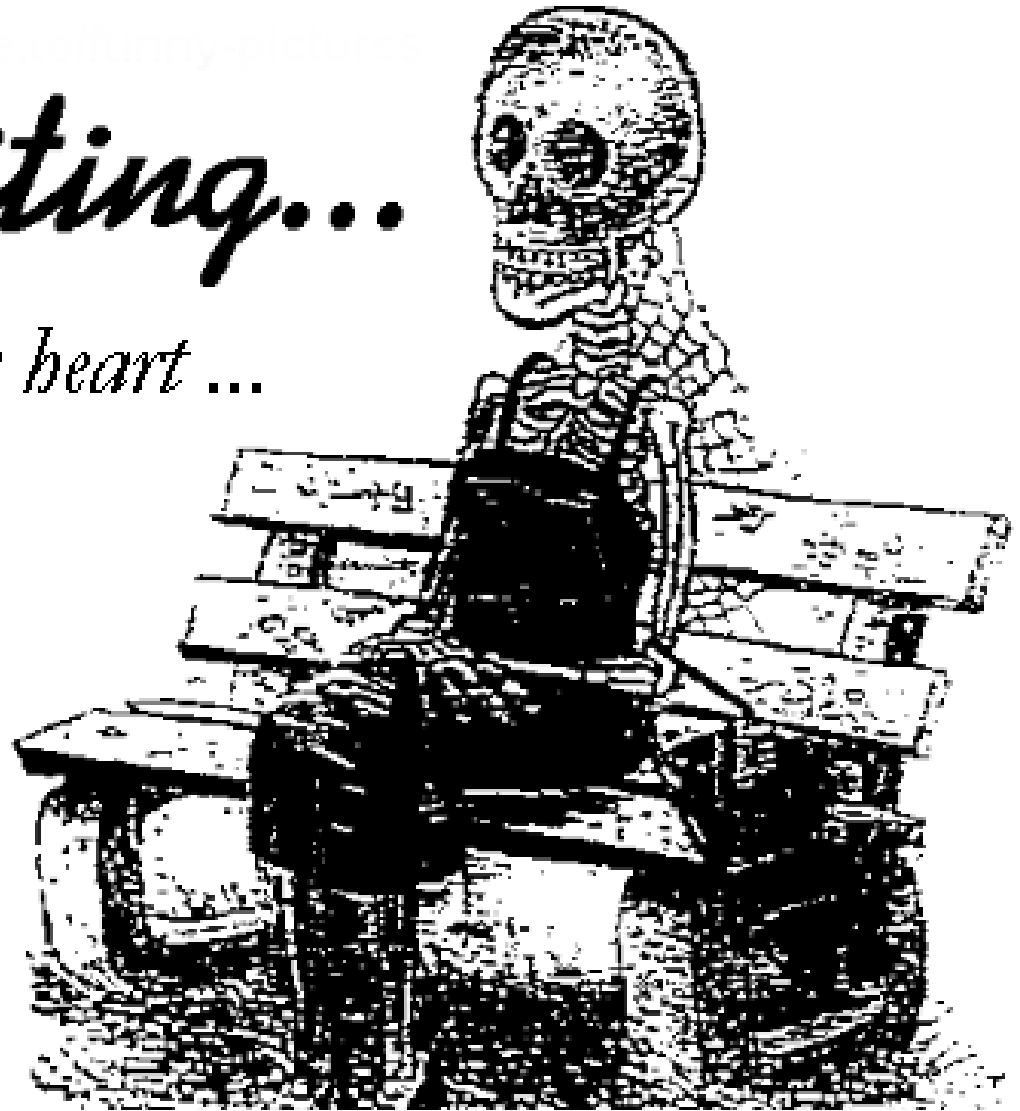

FIG. 1. Shown is a skeletal muscle ventricle (SMV) around an intrathoracic elastic training device (**Top**). A muscular contraction induces a pressure increase within the cavity of the elastic device. Original pressure curves (**Bottom**) during a dynamic training from an SMV of Group 1 without β_2 -stimulation (**A**) and from an SMV of Group 2 supported by clenbuterol (**B**). Clenbuterol-supported SMVs of Group 2 maintained pressure (function) at a high level over time. The stimulation pattern is shown with an increasing number of pulses per burst.

Waiting...

for a new heart ...



ABIOMED

ABIOMED'S
EVS System 5000

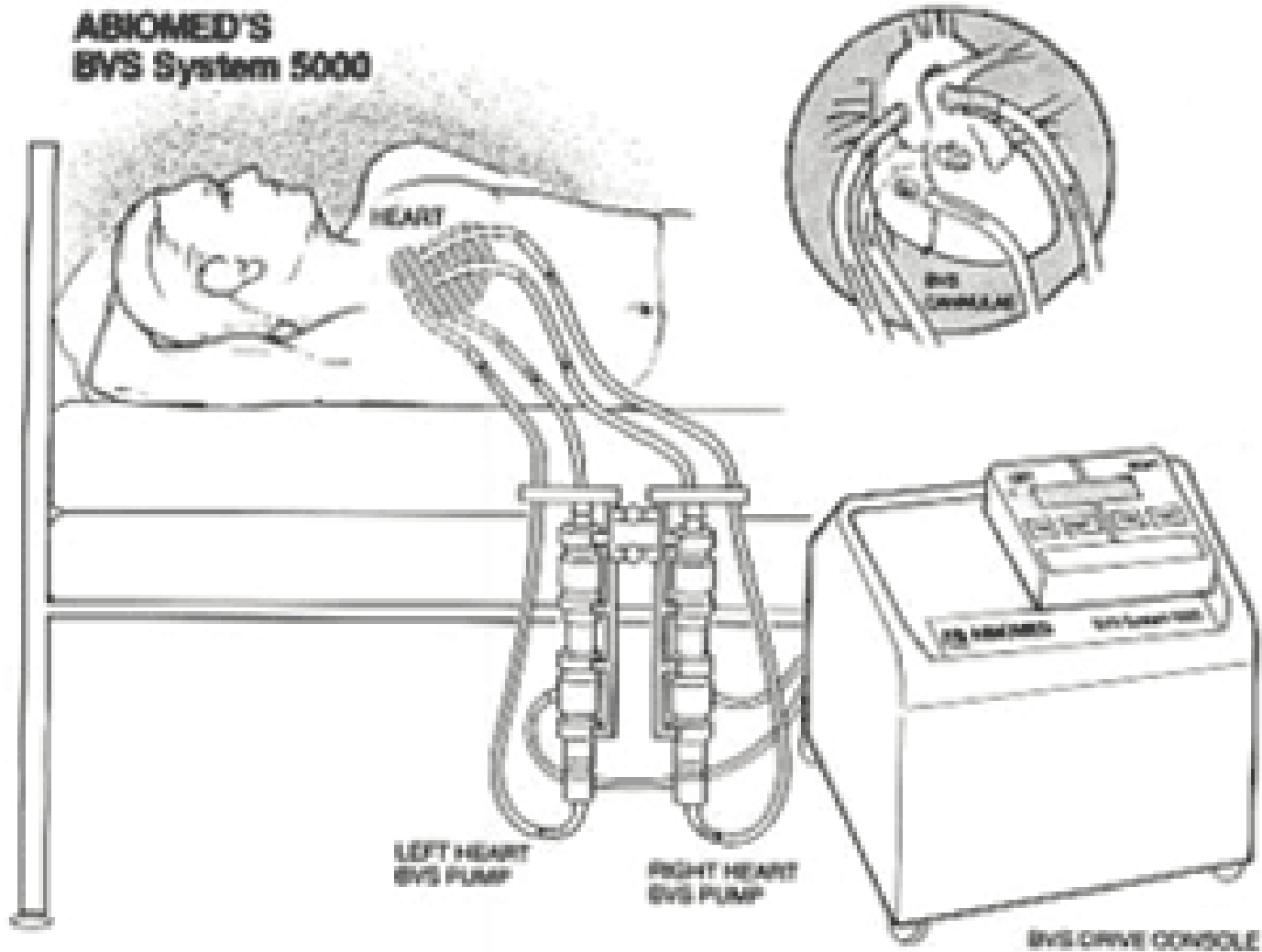

THORATEC BI VAD

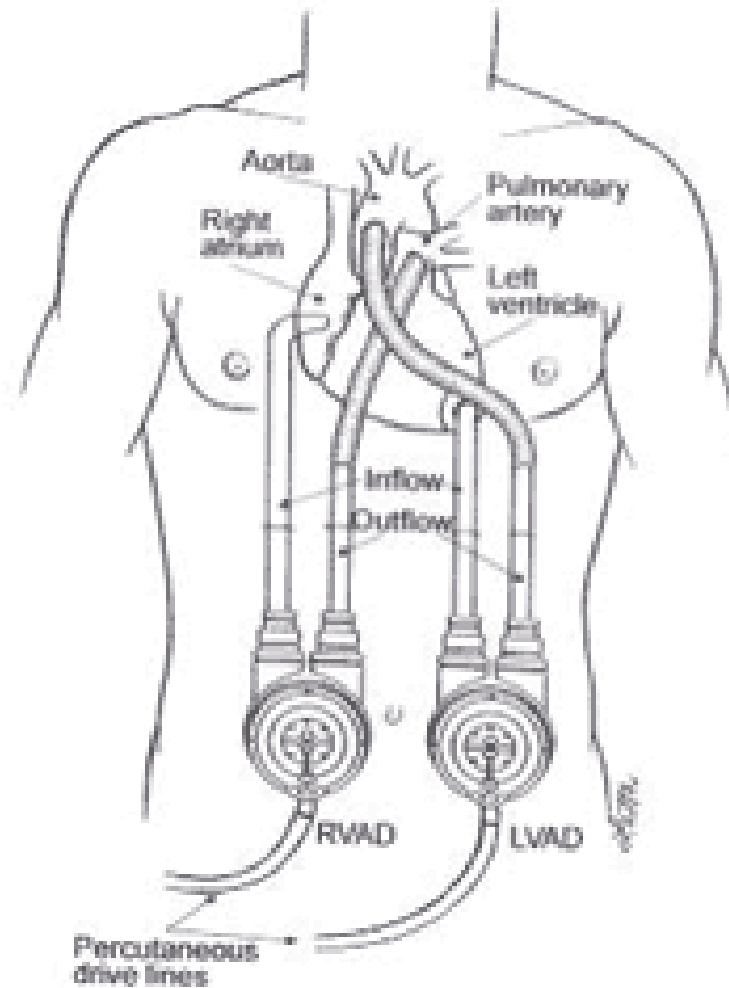

Heart preparation before TAH implantation

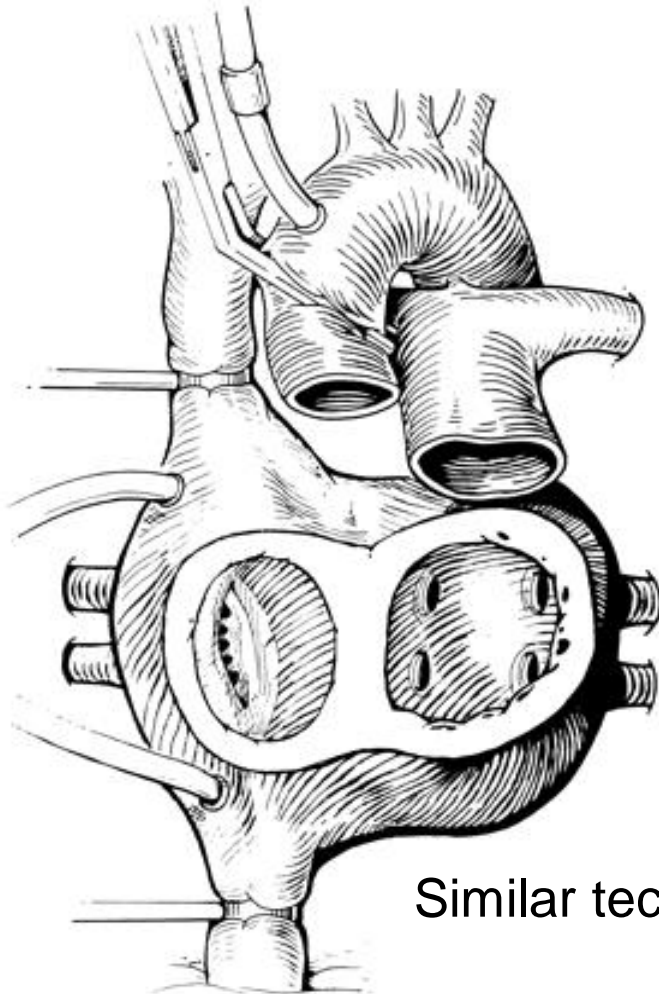

Similar technique with heart transplantation

Air pressure driven artificial heart in connection SynCardia

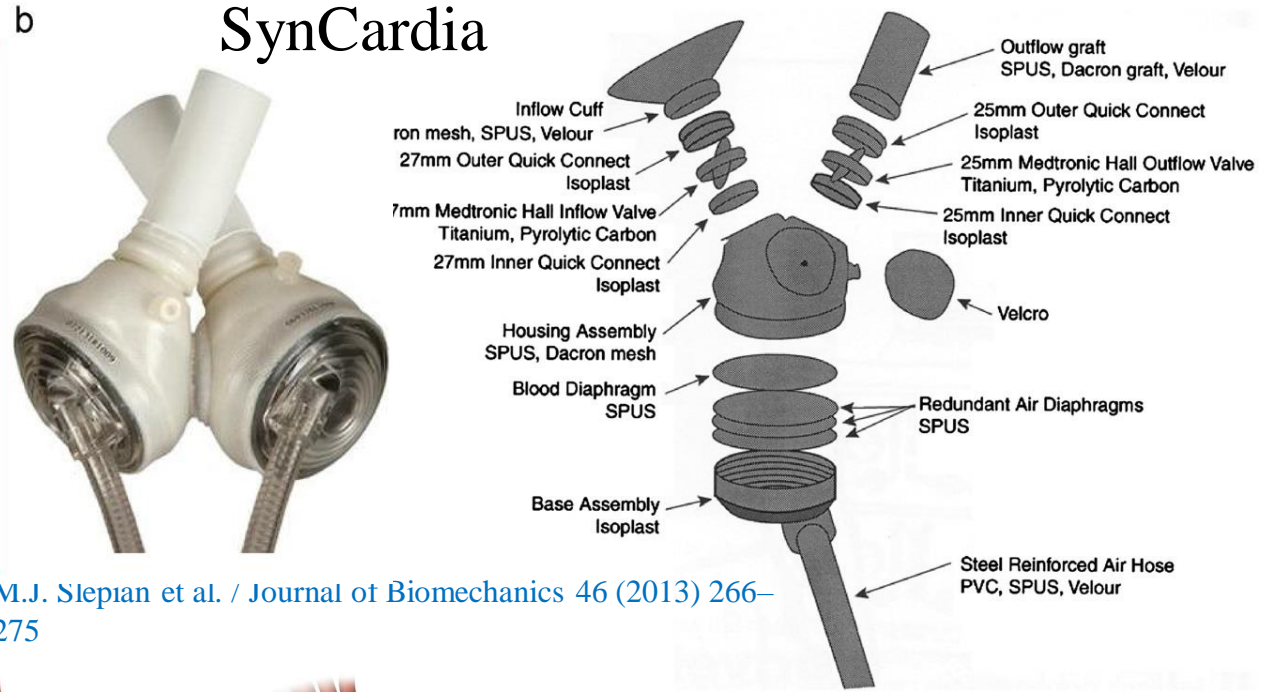
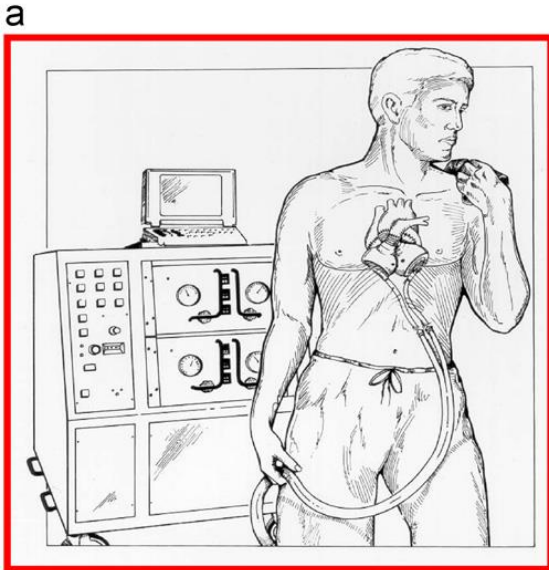

M.J. Slepian et al. / Journal of Biomechanics 46 (2013) 266–275

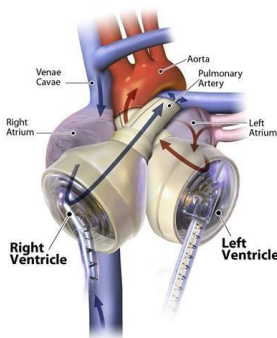
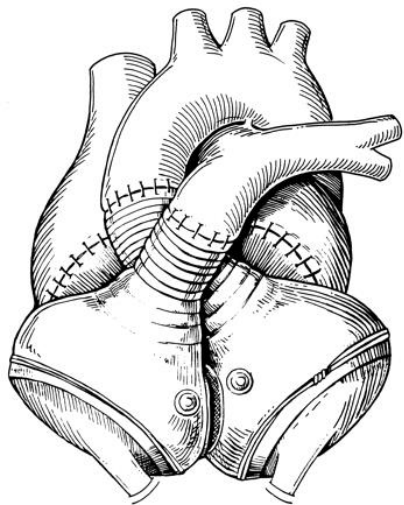

Total Artificial Heart

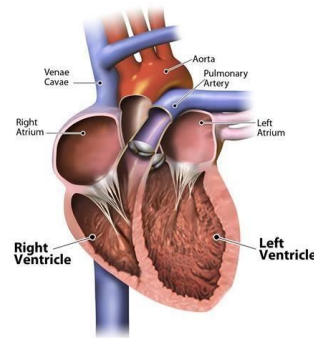

Human Heart

Biomedical Engineering in

<https://www.facebook.com/pages/Biomedical-Engineering-in/139409052794942>



Pneumatic TAH

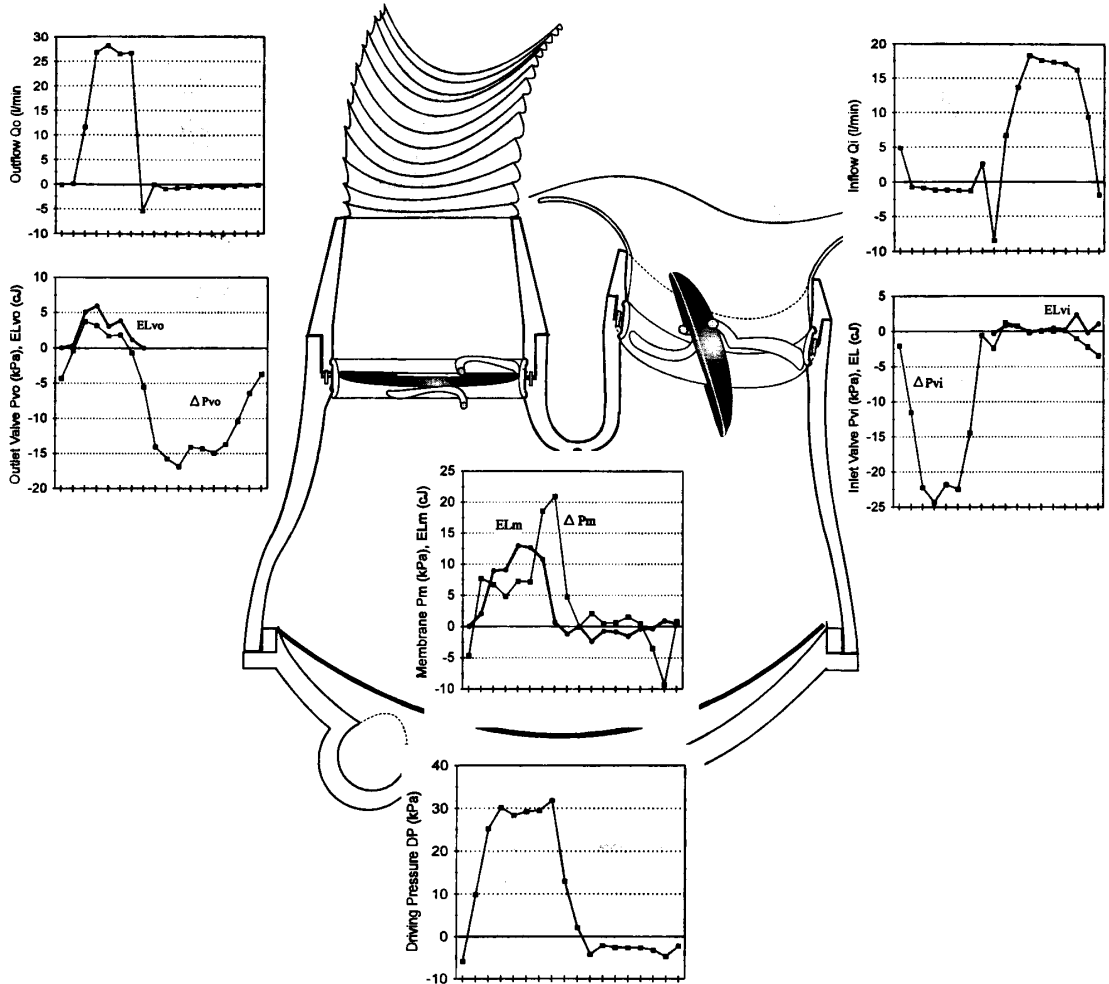
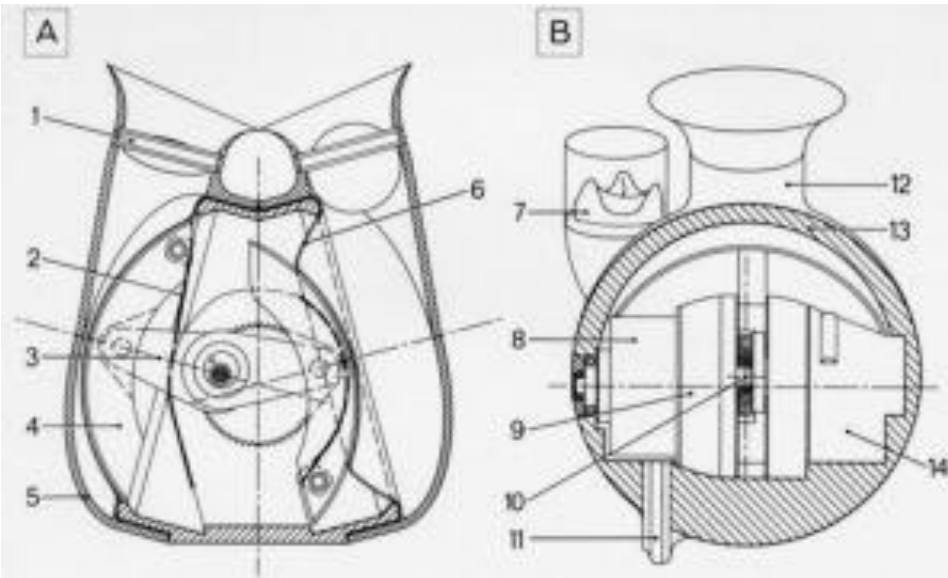
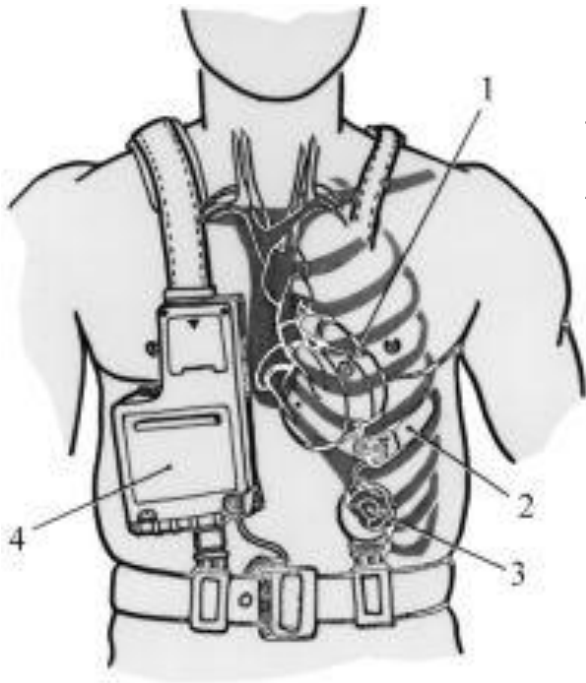
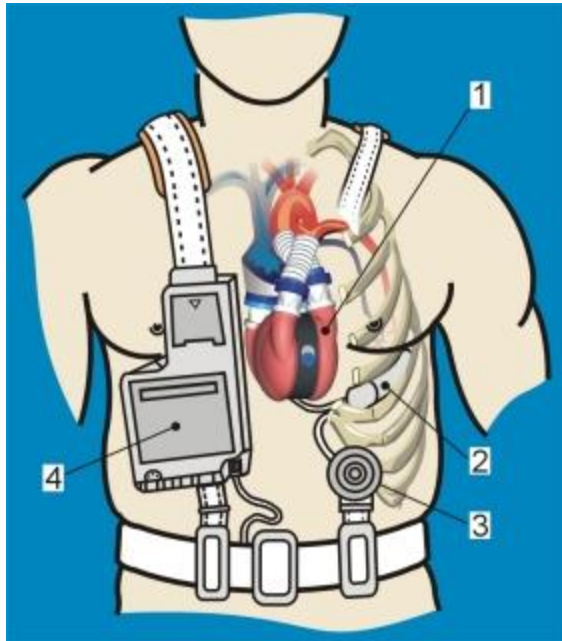

FIG. 1. Shown is 1 cycle of the TAH work in the following test condition ($\bar{\quad}$ mean average value): $\langle AP \rangle = 1$ kPa, $\langle AoP \rangle = 13.3$ kPa, HR = 90 bpm, 40% systole, $DP = 30/-5$ kPa (systole/diastole pressure). Included are the time dependent driving pressure (DP); inlet flow (Q_i) and outlet flow (Q_o); pressure gradients on the membrane, inlet, or outlet valve (ΔP_m , ΔP_{vi} , ΔP_{vo} , respectively); and energy dissipated on the membrane (EL_m), outflow valve (EL_{vo}), and inflow (EL_{vi}) valve.

Diaphragm eccentric CORTAH



Accor - mini Accor - in calf



The Abiomed total artificial heart

The Abiomed total artificial heart (TAH) uses a centrifugal pump to move silicone hydraulic fluid, which drives the device. A sleeved, rotating valve shuttles the fluid between the left and right blood pumps.

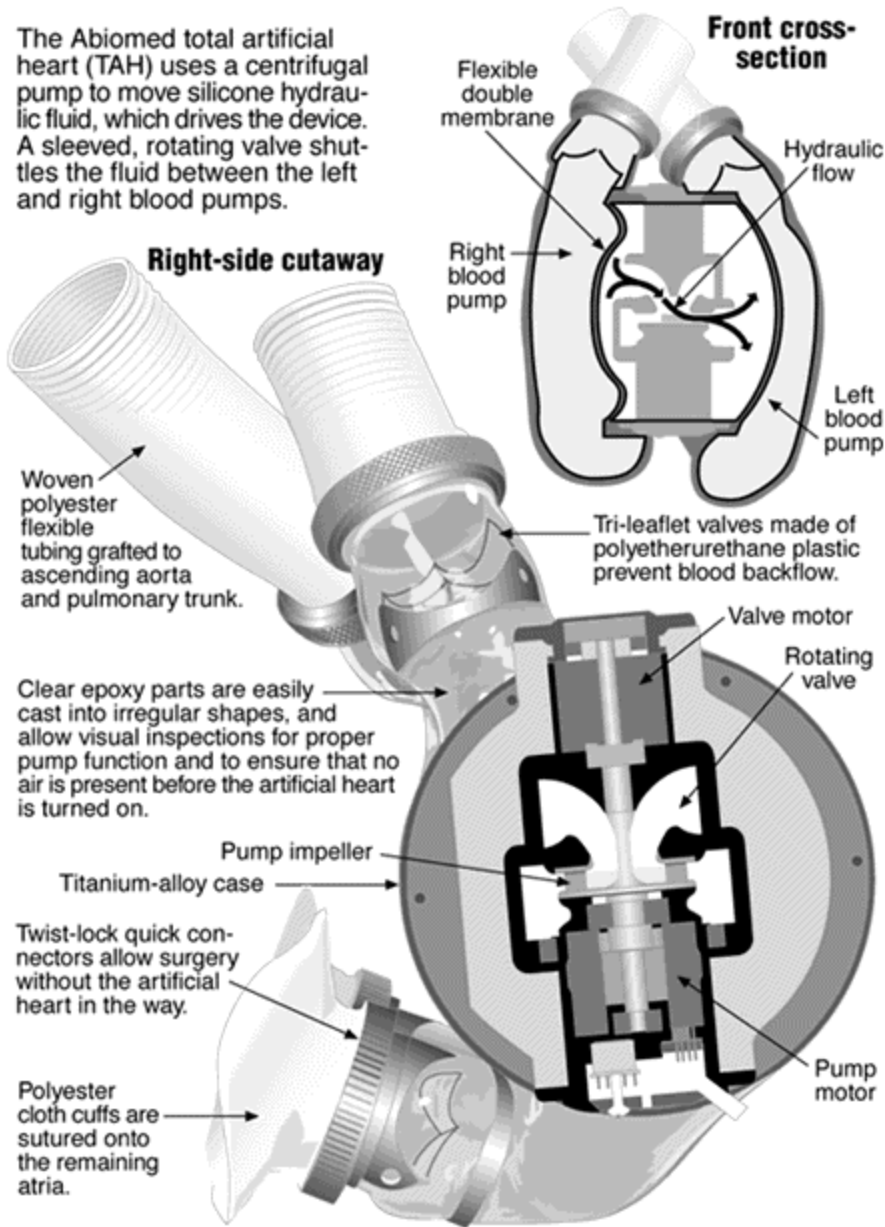

Sources: Steven Parnis, Texas Heart Institute, Abiomed, Inc.

Piston diaphragm

The Penn State total artificial heart

The Penn State total artificial heart (TAH) is driven by an electric motor. The motor turns a rollerscrew nut that pushes the rollerscrew sideways. The motor reverses polarity every four and one-half revolutions, and the rollerscrew is driven in the opposite direction. This back and forth motion within the artificial heart duplicates the pulsing of a real heart.

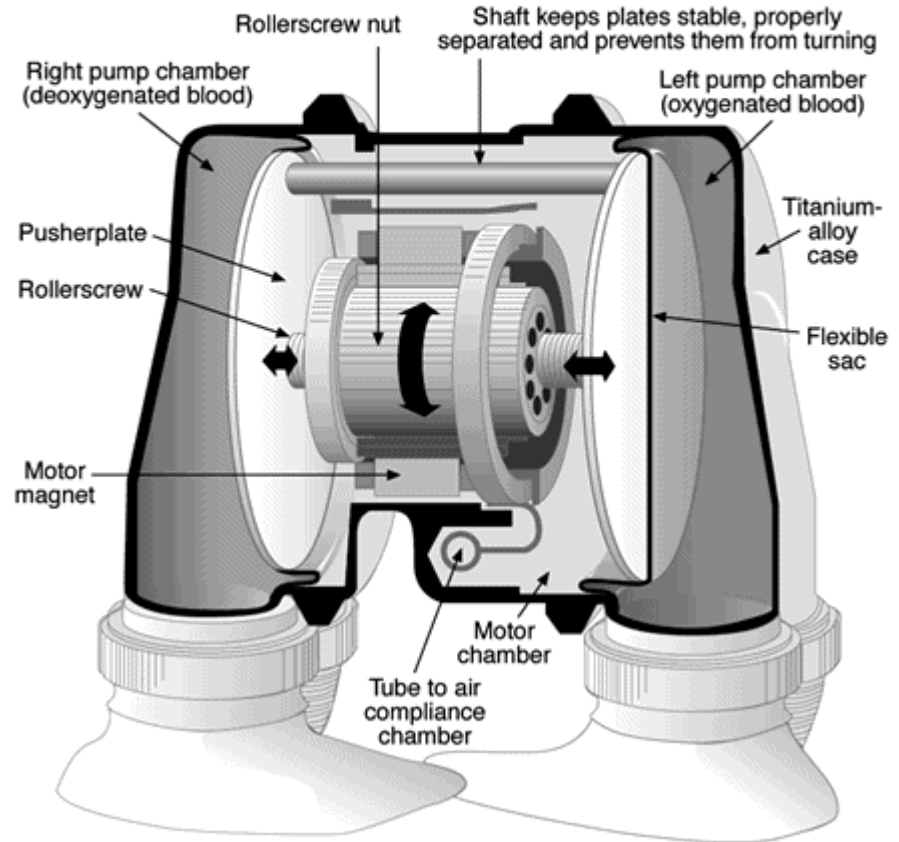

Source: Dr. Gerson Rosenberg, Penn State

TAH motorized

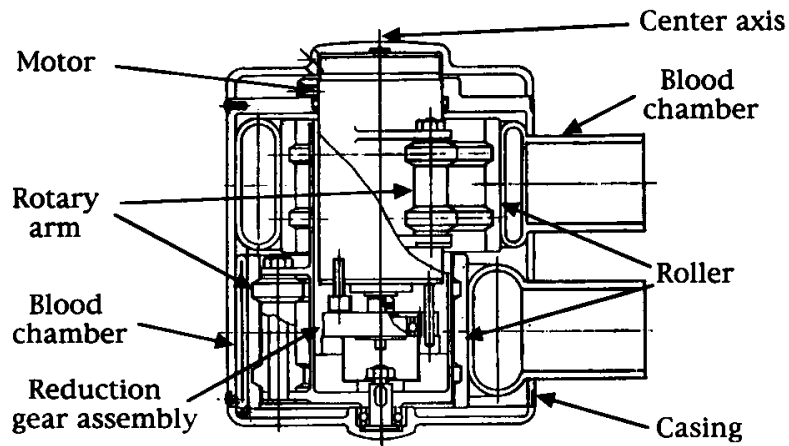

FIG. 1. Shown is the structure of the eccentric roller type TAH developed at Hiroshima University.

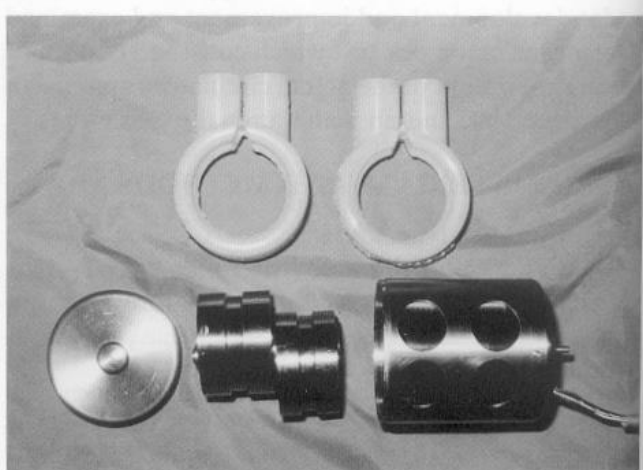

FIG. 3. The main assemblies of the TAH include the blood chambers, eccentric rollers, and casing equipped with motor and gear train.



FIG. 2. The photograph is an external view of the eccentric roller type TAH developed at Hiroshima University.

TAH motorized

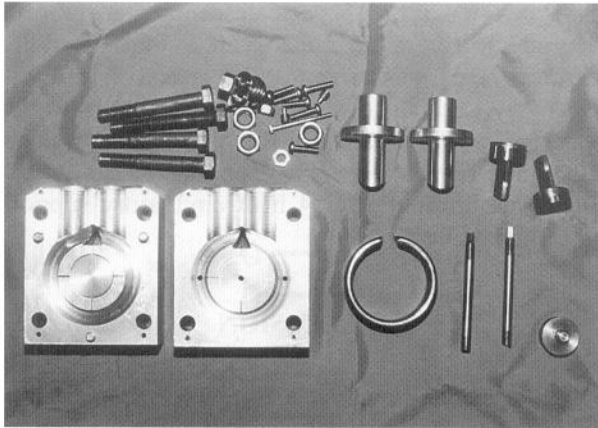

FIG. 4. The photograph shows the main molding parts for the silicone blood chambers.

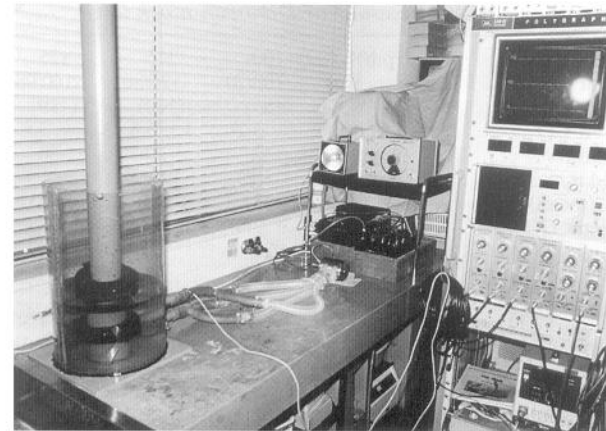

FIG. 6. The photograph shows the setup for the overflow test for endurance evaluation.

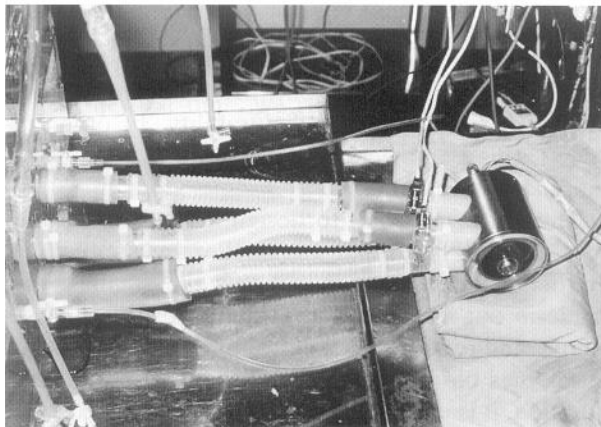

FIG. 5. The photograph shows the TAH during the Donovan mock test for evaluating individual pump flow characteristics.

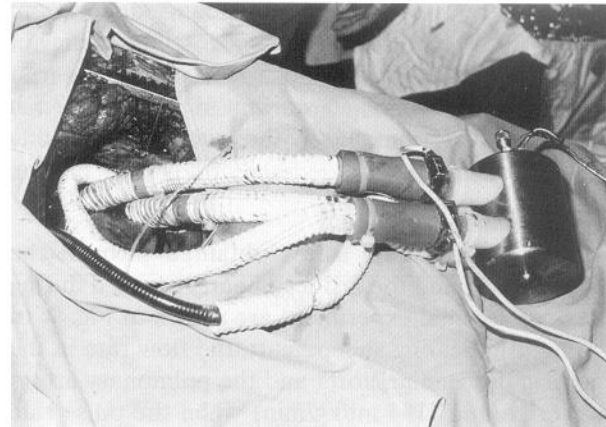

FIG. 7. Shown is the eccentric roller type TAH in the acute animal experiment.

CARMAT



Seventy-five days after a transplant of the world's first artificial heart, the Carmat, the Georges Pompidou European Hospital in Paris has announced the 76-year-old man who received it has died.

The cause of death is not yet known, but the man had been suffering from terminal heart failure and was only given days, or a few weeks, to live.

Copyright © 2014 euronews



Clinical results

Worldwide Registry at a Glance

		HeartMate LVAS		Thoratec VAD	
		IP	VE	Bridge to TX	Postcardiotomy
Implant Information	# of Sites	183		168	
	Total # of Implants	1267	1652	1194	332
	Av. Implant Duration (days)	92	145	44	11
	Max. Support Duration (days)	726	1006	566	118
Demographics	Males : Females (%)	84 : 16	84 : 16	74 : 26	75 : 25
	Median Age (yrs)	49	51	45	53
	Diagnosis: Ischemic CMP (%)	41	43	37	62
	Idiopathic CMP (%)	52	50	41	3
	MI (%)	4	3	8	11
	Other (%)	3	4	13	24

October 2001

The future

CI αύξηση
NYHA I

ΠΩΣ ΚΑΙ ΓΙΟΤΙ ?

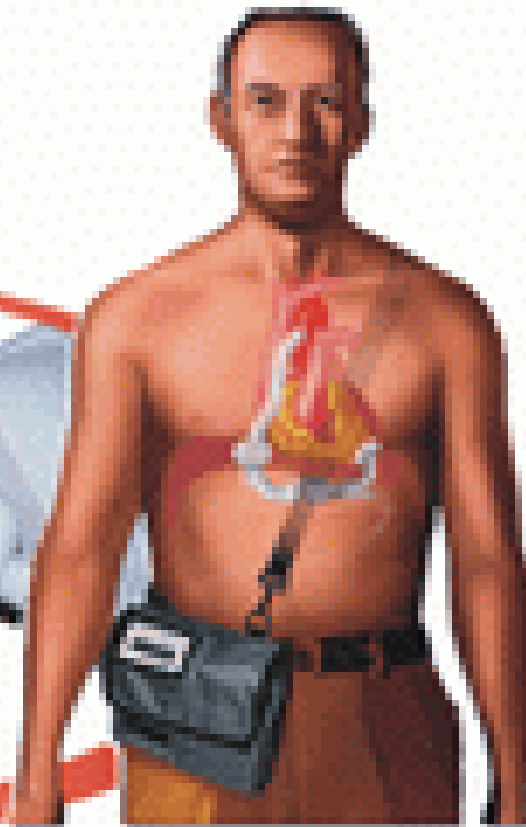

Molecular approach